

**BACKFILL
FOR
SUBSURFACE STRUCTURES**

**DEPARTMENTS OF THE ARMY AND THE AIR FORCE
JUNE 1983**



BACKFILL FOR SUBSURFACE STRUCTURES

		<i>Paragraph</i>	<i>Page</i>
CHAPTER	1.	INTRODUCTION	
		Background	1-1 1-1
		Purpose and scope	1-2 1-1
	2.	PLANNING AND DESIGN OF STRUCTURES AND EX- CAVATIONS TO ACCOMMODATE BACKFILL OPERATIONS	
		General	2-1 2-1
		Effect of excavation and structural configuration on back- fill operations	2-2 2-1
		Backfill problem areas	2-3 2-4
		Instrumentation.....	2-4 2-9
		Optimum cost construction.....	2-5 2-9
	3.	EVALUATION, DESIGN, AND PROCESSING OF BACKFILL MATERIALS	
		General	3-1 3-1
		Evaluation of backfill materials.....	3-2 3-1
		Selection of backfill materials.....	3-3 3-4
		Processing of backfill materials.....	3-4 3-7
	4.	EARTHWORK: EXCAVATION AND PREPARATION FOR FOUNDATIONS	
		Excavation.....	4-1 4-1
		Foundation preparation	4-2 4-2
	5.	BACKFILL OPERATIONS	
		Placement of backfill	5-1 5-1
		Installation of instruments	5-2 5-4
		Postconstruction distress	5-3 5-5
	6.	SPECIFICATION PROVISIONS	
		General	6-1 6-1
		Excavation.....	6-2 6-1
		Foundation preparation	6-3 6-2
		Backfill operations	6-4 6-2
	7.	CONSTRUCTION CONTROL	
		General	7-1 7-1
		Corps acceptance control organization.....	7-2 7-1
		Excavation control techniques.....	7-3 7-3
		Foundation preparation control techniques.....	7-4 7-3
		Backfill quality acceptance control	7-5 7-3
APPENDIX	A.	REFERENCES.....	A-1
	B.	FUNDAMENTALS OF COMPACTION, FIELD COMPACTION TEST METHODS, AND FIELD MOISTURE-DENSITY TEST METHODS	B-1
	C.	BIBLIOGRAPHY.....	C-1

LIST OF FIGURES

<i>Number</i>	<i>Title</i>
2-1	Open backfill zones
2-2	Confined backfill zones
2-3	Complex structures
2-4	Excavation subject to bottom heave
2-5	Excess lateral pressure against vertical walls induced by compaction
7-1	Acceptance rejection scheme for a backfill area
B-1	Compaction Curve
B-2	Typical compaction test curves

*This manual supersedes TM 5-818-4/AFM 88-5, Chapter 5, 7 June 1968.

<i>Number</i>	<i>Title</i>
B-3	Molding Water content versus density-lean clay (laboratory impact compaction)
B-4	Illustration of one-point compaction method
B-5	Illustration of possible error using one- and two-point compaction methods
B-6	Illustration of two-point compaction method
B-7	Correlation between dry density and hand cone resistance at a depth of 6 inches below the surface
B-8	Power applied by the oven to dry moist soils

LIST OF TABLES

<i>Number</i>	<i>Title</i>
3-1	Typical engineering properties of compacted materials
5-1	Summary of compaction criteria

CHAPTER 1

INTRODUCTION

1-1. Background. Military facilities for the Army and Air Force have included construction of buildings and other structures partially below ground surface. In more recent years, missile launching and support structures, fallout and blast-protection shelters, and command-control centers have been constructed below ground surface. Many of these structures were constructed using cut-and-cover procedures and required backfilling within confined areas using various types of soil.

a. Numerous deficiencies in backfilling operations occurred in some of the earlier missile-launch construction programs and caused conditions that jeopardized the proper functioning of those structures. Measures to correct deficiencies were both time consuming and costly. It was recognized that critical areas must be delineated and the causes of the deficiencies be determined and corrected.

b. Measures were taken to alleviate the overall back-filling problems. These measures were progressive modification of design and configuration of structures, more detailed instructions to the construction personnel, and close control during construction to ensure that proper construction practices were being followed.

(1) Some of the problem areas were eliminated by modification of design and configuration of structures to allow easier placement of backfill and to permit access of compaction equipment so that required densities could be achieved.

(2) Construction personnel were issued more detailed field directives covering some of the particularly difficult phases of backfill placement.

(3) Inspector training programs were conducted to point out critical areas and emphasize proper backfill procedures and the need for continuous surveillance and close control.

c. The advent of energy efficient structures, partially embedded below ground level, had increased the use of backfill. In addition, the ever increasing need for fuel conservation requires maximum use of all excavated or onsite materials for backfill to reduce fuel needed for hauling in better materials from offsite. Thus, innovative planning and design and good construction control using rapid check tests are imperative for all backfill operations.

1-2. Purpose and scope. This manual is for the guidance of designers, specification writers, and especially field personnel engaged in designing, planning, and conducting earthwork operations around major deep-seated or subsurface structures.

a. The greatest deficiencies in earthwork operations around deep-seated or subsurface structures occur because of improper backfilling procedures and inadequate construction control during this phase of the work. Therefore, primary emphasis in this manual is on backfilling procedures. Design and planning considerations, evaluation and selection of materials, and other phases of earthwork construction are discussed where pertinent to successful backfill operations.

b. Although the information in this manual is primarily applicable to backfilling around large and important deep-seated or buried structures, it is also applicable in varying degrees to backfilling operations around all structures, including conduits.

CHAPTER 2
PLANNING AND DESIGN OF STRUCTURES AND
EXCAVATIONS TO ACCOMMODATE BACKFILL OPERATIONS

2-1. General. Many earthwork construction problems can be eliminated or minimized through proper design, thorough planning, and recognition of problem areas effecting backfill operations. Recognition and consideration must be given in planning to design features that will make backfilling operations less difficult to accomplish. Examples of problem areas and how forethought in design and planning can help to eliminate backfill deficiencies are presented in the following paragraphs.

2-2. Effect of excavation and structural configuration on backfill operations. Some of the problems encountered in earthwork construction are related to the excavation and the configuration of the structures around which backfill is to be placed. It is the designer's responsibility to recognize these problems and to take the necessary measures to minimize their impact on the backfill operations.

a. Open zones. An open zone is defined as a backfill area of sufficient dimensions to permit the operation of heavy compaction equipment without endangering the integrity of adjacent structures around which compacted backfill operations are conducted. Figure 2-1 shows examples of open zones. In these zones where large compaction equipment can operate, it is generally not too difficult to obtain the desired density if appropriate materials and proper backfill procedures are used. For areas that can be economically compacted by heavy equipment, the designer can avoid problems by including in the design provisions sufficient working space between structures or between excavation slopes and structures to permit access by the heavy compaction equipment. Generally, a working space of at least 12 feet between structure walls and excavation slopes and at least 15 feet between structures is necessary for heavy equipment to maneuver. In addition to maneuvering room, the designer must also consider any adverse loading caused by the operation of heavy equipment too close to structure walls, as discussed in paragraph 2-3d.

b. Confined zones. Confined zones are defined as areas where backfill operations are restricted to the use of small mechanical compaction equipment (fig. 2-2) either because the working room is limited or because heavy equipment (fig. 2-1) would impose excessive soil pressures that could damage the structure. Most deficiencies in compacted backfill around subsurface structures have occurred

in confined zones where required densities are difficult to achieve because of restricted working room and relatively low compaction effort of equipment that is too lightweight. The use of small equipment to achieve required compaction is also more expensive than heavy equipment since thinner lifts are required. However, because small compaction equipment can operate in spaces as narrow as 2 feet in width, such equipment is necessary to achieve the required densities in some areas of most backfill projects. Therefore, the designer should plan structure and excavation areas to minimize the use of small compaction equipment.

c. Structure configuration. The designer familiar with backfilling operations can avoid many problems associated with difficult to reach confined zones, which are created by structural shapes obstructing the placement and compaction of backfill, by considering the impact of structural shape on backfill operations. In most cases, structural shapes and configurations that facilitate backfill operations can be used without significantly affecting the intended use of the structure.

(1) *Curved bottom and wall structures.* Areas below the spring line of circular, elliptical, and similar shaped structures are difficult to compact backfill against because compaction equipment cannot get under the spring line. If possible, structures should be designed with continuously curved walls and flat floors such as in an igloo-shaped structure. For structures where a curved bottom is required to satisfy the intended function, it may be advisable for the designer to specify that a template shaped like the bottom of the structure be used to guide the excavation below the spring line so that uniform foundation support will be provided.

(2) *Complex structures.* Complex structures have variable shaped walls and complex configurations in plan and number of levels. These structures can also be simple structures interconnected by access shafts, tunnels, and utility conduits. Because of their irregular shapes and configurations the different types of structures significantly increase excavation and backfill problems.

(a) Typical examples of complex structures are stepped multilevel structures and multichambered structures with interconnecting corridors (fig. 2-3). Complex structures are generally more difficult to



Figure 2-1. Open backfill zones.

compact backfill around and are more likely to have settlement problems (para 2-3a). Although the multilevel step structure (fig. 2-3a) is not particularly difficult to compact backfill around, at least for the first level, the compaction of backfill over the offset structure will generally require the use of small equipment. Small equipment will also be required for compaction of backfill around and over the access corridor and between the two chambers (fig. 2-3b). Where possible, the design should accommodate intended functions into structures with uniformly shaped walls and a simple configuration.

(b) Where structures of complex configurations are necessary, construction of a three-dimensional model during the design and planning phases will be extremely beneficial. From the model, designers can more easily foresee and eliminate areas in which it would be difficult to place and compact backfill.

d. Service conduits. Since compaction of backfill is difficult around pipes and conduits, utility lines should

be grouped together or placed in a single large conduit where feasible rather than allowed to form a haphazard maze of pipes and conduits in the backfill. Utility lines should be run either horizontally or vertically wherever possible. Plans for horizontally run appurtenances, such as utility lines, access tunnels, and blast-delay tubing, should be coordinated with the excavation plans so that wherever feasible these appurtenances can be supported by undisturbed soils rather than by compacted backfill.

e. Excavation plans. The excavation plans should be developed with the backfill operations and the structure configurations in mind. The excavation and all completed structures within the excavation should be conducive to good backfill construction procedures, and access should be provided to all areas so that compaction equipment best suited to the size of the area can be used. The plans for excavation should also provide for adequate haul roads and ramps. Positive excavation slopes should be required in all types of soil

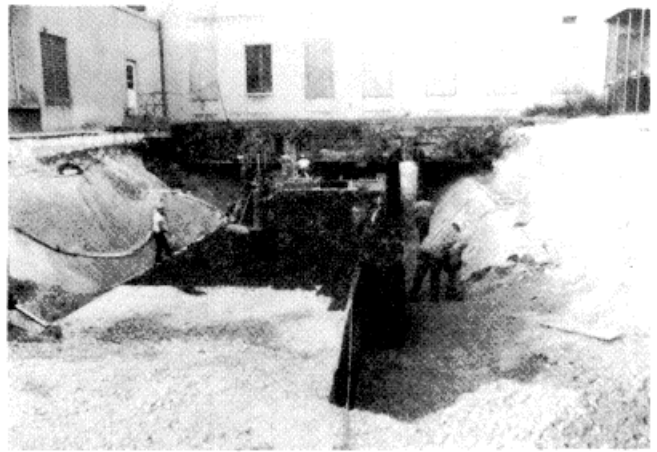
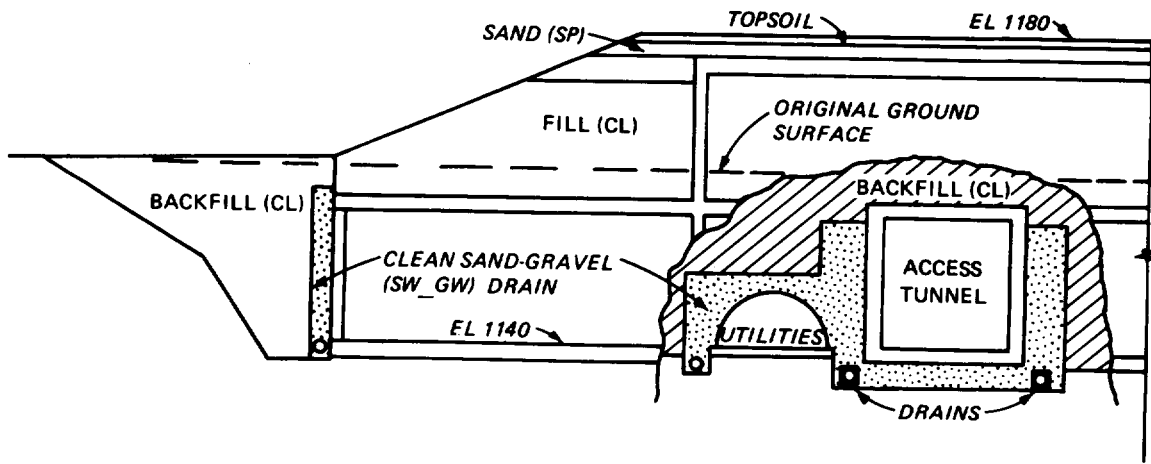
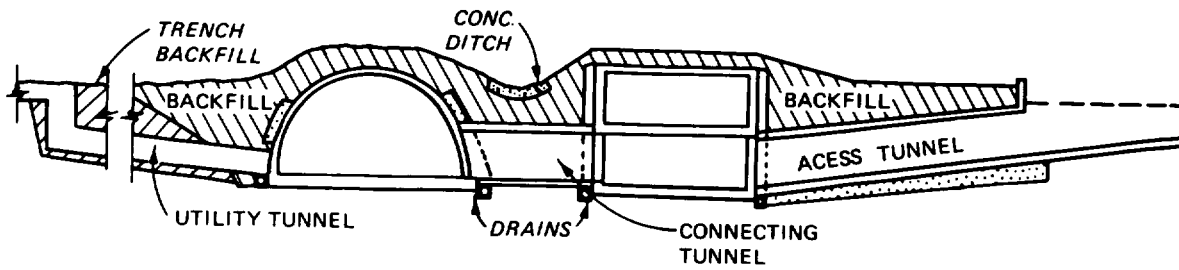

Figure 2-2. Confined backfield zones.



(a) TWO-STORY STRUCTURE



(b) CONNECTING STRUCTURES

Figure 2-3. Complex structures.

deposits to facilitate compaction of backfill against the slope and to ensure good bond between the backfill and the excavation slopes. Loose material should be removed from the excavation slopes; in some cases, benches may be required to provide a firm surface to compact backfill against.

f. Lines and grades. Care should be exercised in planning lines and grades for excavation to ensure that uniform, adequate support is provided at the foundation level of important structures. Generally, foundations consisting of part backfill and part undisturbed materials do not provide uniform bearing and should be avoided wherever possible. The foundation should be overexcavated where necessary, and backfilled with compacted select material to provide uniform support for the depth required for the particular structure. Where compacted backfill is required beneath a structure, the minimum depth specified should be at least 18 inches.

g. Thin-walled metal structures. Thin-walled, corrugated metal structures are susceptible to deflections of structural walls when subjected to backfill loads. Adverse deflections can be minimized by planning backfill operations so that compacted backfill is brought up evenly on both sides of the structure to ensure uniform stress distribution. Temporary surcharge loads applied to the structure crown may also be required to prevent vertical distortions and inward deflection at the sides.

2-3. Backfill problem areas. Other features that have the potential to become problem areas are discussed in the following paragraphs. These potential problem areas have to be considered during the planning and design phases to minimize deficiencies in structure performance associated with backfill placement and to make backfilling operations less difficult.

a. Settlement and downdrag. In the construction of underground structures and particularly missile-launch-site facilities, tolerances to movement are often considerably less than those in normal construction.

The design engineer must determine and specify allowable tolerances in differential settlement and ensure that differential settlement is minimized and/or accommodated. Settlement analysis procedures are outlined in TM 5-818-1/AFM 88-3, Chapter 7. See appendix A, References.

(1) *Critical zones.* Critical backfill zones are those immediately beneath most structures. Consolidation and swelling characteristics of backfill materials should be thoroughly investigated so that materials having unfavorable characteristics will not be used in those zones. Some settlement can be expected to take place, but it can be minimized by requiring a higher than normal compacted density for the backfill. Cohesive backfill compacted at a water content as little as 3 to 4 percentage points below optimum may result in large settlements caused by collapse of nonswelling soil

material or heave of swelling materials upon saturation after construction. Compacting cohesive backfill material at optimum water content or slightly on the wet side of optimum generally will reduce the amount of settlement and swelling that would occur. The reduction should be confirmed by consolidation and swell tests on compacted specimens (para 3-2b(4)).

(2) *Service conduits.* Settlement within the backfill around structures will also occur. A proper design will allow for the estimated settlement as determined from studies of consolidation characteristics of the compacted backfill. Where service conduits, access corridors, and similar facilities connect to the structure oversized sleeves, flexible connections and other protective measures, as appropriate, may be used to prevent damage within the structure.

(3) *Differential settlement.* Complex structures are more susceptible to differential settlement because of the potential for large variations in loads carried by each component foundation. In the multilevel stepped structure (fig. 2-3a), the foundation supporting the lower level offset component must also support the volume of backfill over that part of the structure. Measures must be taken to ensure that the proper functioning of all elements is not hampered by differential settlement. The increased cost of proper design and construction where unusual or difficult construction procedures are required is insignificant when compared with the cost of the structure. The cost of remedial measures to correct deficiencies caused by improper design and construction usually will be greater than the initial cost required to prevent the deficiencies.

(4) *Downdrag.* In addition to conventional service loads, cut and cover subsurface structures are susceptible to downdrag frictional forces between the structure and the backfill that are caused by settlement of the backfill material adjacent to and around the structure. Downdrag loads can be a significant proportion of the total vertical load acting on the structure and must be considered in the structure settlement analysis. Structure-backfill friction forces may also generate significant shear forces along the outer surface of structures with curve-shaped roofs and walls. The magnitude of the friction forces depends upon the type of backfill, roughness of the structure's surface, and magnitude of earth pressures acting against the structure. Techniques for minimizing downdrag friction forces generally include methods that reduce the structure surface roughness such as coating the structure's outer surface with asphalt or sandwiching a layer of polyethylene sheeting between the structure's outer surface and fiberboard (blackboard) panels. Backfill settlement and associated downdrag can also be minimized

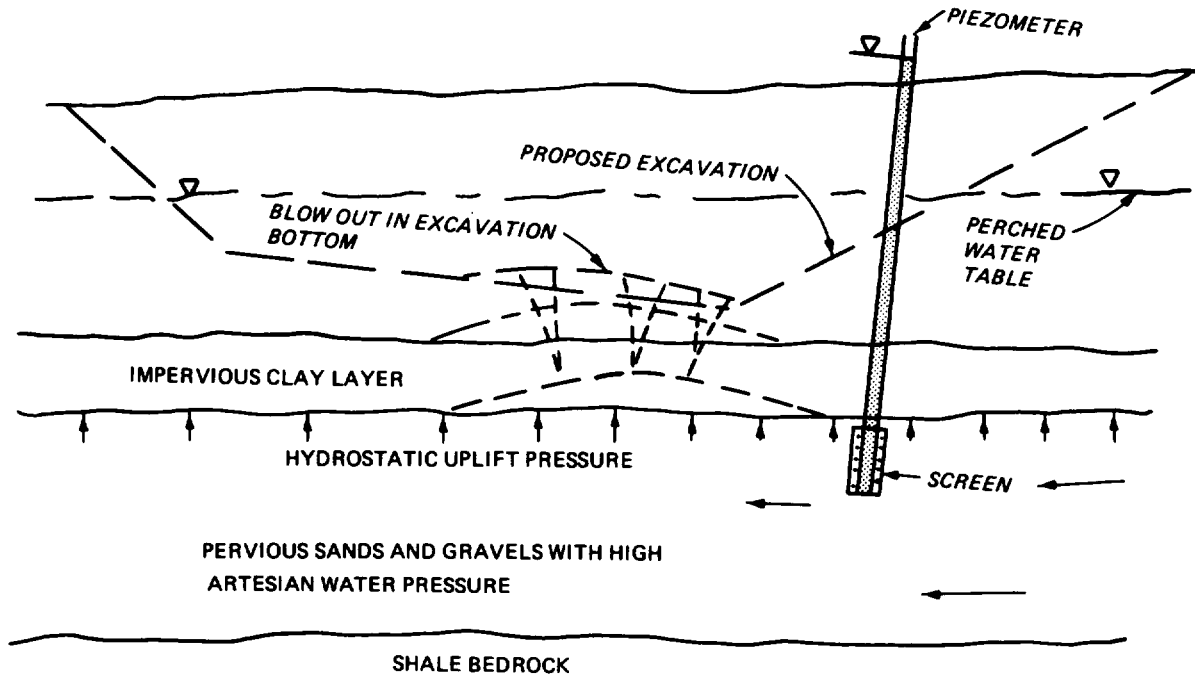

Figure 2-4. Excavation subject to bottom heave.

by requiring higher backfill densities adjacent to the structure.

b. Groundwater. Groundwater is an important consideration in planning for construction of subsurface structures. If seepage of groundwater into the excavation is not adequately controlled, backfilling operations will be extremely difficult. The groundwater level must be lowered sufficiently (at least 2 to 3 feet for granular soils and as much as 5 to 10 feet for fine-grained soils below the lowest level of backfilling) so that a firm foundation for backfill can be established. If the level is not lowered, the movement of hauling or compaction equipment may pump seepage water through the backfill, or the initial backfill layers may be difficult to compact because of an unstable foundation. Since the proper water content of the backfill is essential for achieving proper compaction, prevention of groundwater seepage into the excavation during backfilling operations is mandatory. Figure 3-14 of EM 1110-2-1911 shows a method for dewatering rock foundations.

(1) The contractor is generally responsible for the design, installation, and operation of dewatering equipment. The Corps of Engineers is responsible for specifying the type of dewatering system and evaluating the contractor's proposed dewatering plan. Since the dual responsibility of the contractor and the Corps relies on a thorough understanding of groundwater conditions, inadequate dewatering efforts can be mini-

minimized by adequate planning and implementation of groundwater investigations.

(2) The possibility of hydraulic heave in cohesive material must also be investigated to ensure stability of the excavation floor. Hydraulic heave may occur where an excavation overlies a confined permeable stratum below the groundwater table (fig. 2-4). If the upward hydrostatic pressure acting at the bottom of the confining layer exceeds the weight of overburden between the bottom of the excavation and the confining layer, the bottom of the excavation will rise bodily even though the design of the dewatering system is adequate for control of groundwater into the excavation. To prevent heave, the hydrostatic pressure beneath the confined stratum must be relieved.

(3) Subsurface structures located in part or wholly below the groundwater table require permanent protection against groundwater seepage. The type of protection may range from simple impermeable barriers to complex permanent dewatering systems.

(4) Dewatering and groundwater control procedures are described in TM 5-818-5/NACFAC P-418/AFM 88-5, Chapter 6.

c. Gradation and filter criteria for drainage materials. Groundwater control is often accomplished by ditches positioned to intercept the flow of groundwater and filled with permeable granular material. The water is generally collected in perforated pipes located at the bottom of the ditch and pumped to a suitable

discharge area. Such drainage systems are referred to as filter drains. The gradation of the granular filter material is critical for the functioning of the system. Selection of the proper gradation for the filter material is dependent upon the gradation of the material that is being drained. Drainage of silts and clays usually requires a graded filter made up of several layers of granular material with each layer having specific requirements for maximum grain size and gradation. Details on the design of filter drains are presented in TM 5-818-5/NAVFAC P-418/AFM 88-5, Chapter 6.

(1) *Selected material.* If materials at the jobsite do not meet the designed filter requirements, select material must be purchased from commercial sources and shipped to the jobsite. Filter material must be stockpiled according to gradation. For graded filter systems, the materials must be placed with care to minimize mixing of individual components.

(2) *Filter cloths.* Both woven and nonwoven filter cloths, which have been found satisfactory for use as a filter media for subsurface drains, are available. When granular filter materials are not economically available, a single wrap of filter cloth around a pipe may be used in lieu of a coarser backfill. When available granular filter material is too coarse to satisfy filter criteria for the protected soil, a single layer of filter cloth may be used adjacent to the protected soil. To reduce the chance of clogging, no filter cloth should be specified with an open area less than 4 percent and or equivalent opening size (EOS) of less than the No.100 sieve (0.0059 inch). A cloth with openings as large as allowable should be specified to permit drainage and prevent clogging. Additional information on airfield drainage is contained in TM 5-820-2/AFM 88-5, Chapter 2.

(3) *Other uses.* Filter cloth can also provide protection for excavated slopes and serve as a filter to prevent piping of fine-grained soils. In one project, sand was not available for backfill behind a wall and coarse gravel had to be used to collect seepage. The filter cloth used to protect the excavated slope served as a filter against piping of the natural silty clay under seepage gradients out of the excavated slope after the coarse gravel backfill was placed.

d. *Earth pressures.* The rationale design of any structure requires the designer to consider all loads acting on the structure. In addition to normal earth pressures associated with the effective pressure distribution of the backfill materials, subsurface cut-and-cover structures may also be subjected to surcharge loads caused by heavy equipment operating close to the structure and by increased permanent lateral earth pressures caused by compaction of backfill material with heavy equipment. Procedures for predicting normal earth pressures associated with the effective pressure of backfill materials are discussed in TM

5-818-1/AFM 88-3, Chapter 7, EM 1110-2-2902, and EM 1110-2-2502.

(1) Exact solutions for surcharge earth pressures generated by heavy equipment (or other surcharge loads) do not exist. However, approximations can be made using appropriate theories of elasticity such as Boussinesq's equations for load areas of regular shape or Newmark's charts for irregular shaped load areas as given in NAVFAC DM-7. As a conservative guide, heavy-equipment surcharge earth pressures may be minimized by specifying that heavy compaction equipment maintain a horizontal distance from the structure equivalent to the height of the backfill above the structure's foundation.

(2) Compaction-induced earth pressures can cause a significant increase in the permanent lateral earth pressures acting on a vertical wall of a structure (fig. 2-5a). This diagram is based on the assumption that the equipment can operate to within 6 inches of the wall. Significant reductions in lateral pressures occur as the closest allowable distance to the wall is increased (fig. 2-5b). For an operating distance 5 feet from the wall, the induced horizontal earth pressure is much less than that caused by the backfill. The magnitude of the increase in lateral pressure is dependent, among other factors, on the effective weight of the compaction equipment and the weight, earth pressure coefficient, and Poisson's ratio of the backfill material. Compaction-induced earth pressures against walls are also described in TM 5-818-1/AFM 88-3, Chapter 7, and EM 1110-2-2502.

(3) The designer must evaluate the economics of the extra cost of structures designed to withstand very close-in operation of heavy compaction equipment versus the extra cost associated with obtaining required compaction of backfill in thin lifts with smaller compaction equipment. A more economical alternative might be to specify how close to the walls different weights of compaction equipment can be operated.

(4) One method of reducing lateral earth pressures behind walls has been to use about 4 feet of uncompacted granular (sand or gravel) backfill above the base of the wall. Soil backfill can then be compacted in layers above the granular backfill. Compression of the granular material prevents the buildup of excessive lateral pressures against the wall.

e. *Structural backfill.* Structural backfill is defined as the compacted backfill required over and around a structure to prevent damage from heavy equipment operating over or near the structure. This backfill must be compacted using small compaction equipment, such as mechanical rammers or vibratory-plate compactors, or intermediate size equipment such as walk-behind, dual-drum vibratory rollers. The horizontal and vertical distances from the structure for which structural backfill is required should be deter

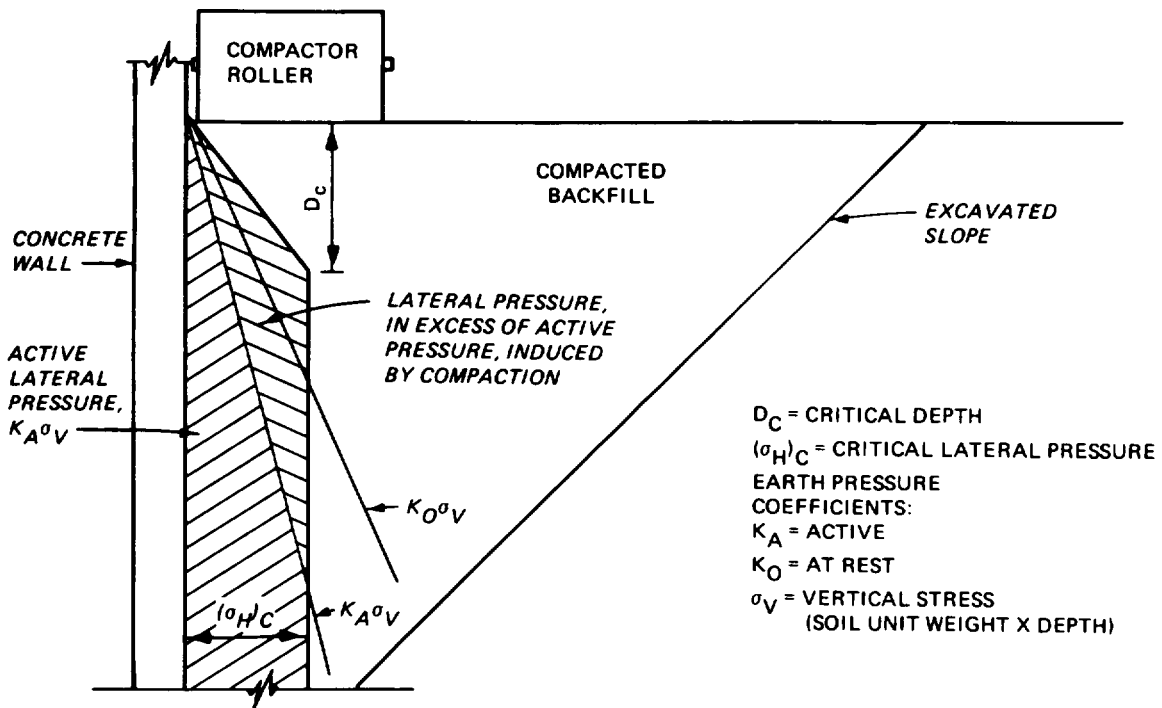

COMPACTION EQUIPMENT	CRITICAL DEPTH D_c , FT	$(\sigma_H)_c$ psf
10-TON SMOOTH WHEEL ROLLER	1.9	420
3.2-TON VIBRATORY ROLLER	1.7	400
1.4-TON VIBRATORY ROLLER	1.2	260
400-KG VIBRATORY PLATE	1.5	340
120-KG VIBRATORY PLATE	1.0	240

a. MAXIMUM INDUCED LATERAL PRESSURES

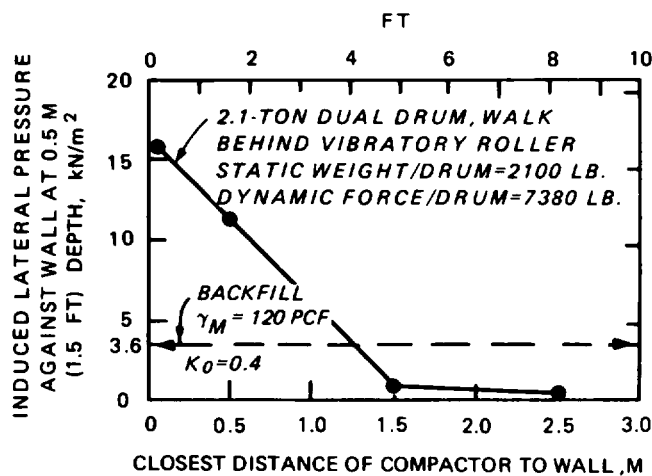

b. EFFECT OF DISTANCE FROM WALL

Figure 2-5. Excess lateral pressure against vertical walls induced by compaction.

mined from estimates of loads acting on the structure caused by heavy equipment and on the strength of the embedded structure members as discussed in d above. A 2-foot cover over small utility conduits and pipes is adequate protection where proper bedding procedures are followed. The minimum cover requirements over larger diameter (6 inches or greater), rigid and flexible pipes are presented in appendix II of TM 5-8204/AFM 88-5, Chapter 4.

f. Slopes and bracing. Where open excavation is planned, consideration should be given to the slopes to which the materials to be encountered can be cut and remain stable. The stability analysis should include the strength of the materials, groundwater conditions, and any surcharge load that may be imposed as the result of stockpiles being placed or equipment operating near the crest of the excavation. Slope stability evaluation procedures are described in TM 5-818-1/AFM 88-3, Chapter 7. Shoring and bracing should be used to support excavation slopes where it is not feasible to excavate to stable slopes (TM 5-818-1/AFM 88-3, Chapter 7). Requirements for shoring and bracing safety are presented in EM 385-1-1.

g. Bedding for curved-bottom structures. Foundations for pipes, conduits, access tunnels, fuel and water storage tanks, and other curved-bottom structures constructed within the backfill are considered critical zones that require special attention. Any bedding material used should be free of stones or other large particles that would lead to nonuniform bearing. One of the most important functions of any bedding procedure is to provide firm support along the full length of the structure. For areas where it is difficult to perform field density control tests because of limited working space, a procedure to ensure that proper compaction is obtained must be employed. Several methods of obtaining adequate bedding are discussed in paragraph 5-1c (2).

h. Cold weather construction. Cold weather can have a very adverse effect on backfilling operations and can cause considerable delay. If possible, the project should be planned to complete backfilling operations prior to any extended period of freezing temperatures. The contractor and the resident engineer must keep up to date with weather data so that the contractor can plan the equipment and construction force required to meet the construction schedule and to protect the work already accomplished.

(1) The designer must establish definite limitations and requirements regarding placement of backfill when the ambient temperature is below freezing. Most inorganic soils, particularly silts and lean clays, containing 3 percent, by weight, or more of particles finer than 0.02 millimetre in diameter are frost susceptible. Such soils, when frozen in the presence of an

available source of water, develop segregated ice in the form of lenses, layers, veins, or masses commonly, but not always oriented normal to the direction of heat loss. The expansion of the soil mass resulting from ice segregation is called frost heave. Frost heave of soil under and against structures can cause detrimental effects, which can be compounded during subsequent thawing by differential movement, loss of density, and loss of shear strength. Soils of this type should not be placed during or immediately prior to freezing temperatures and must not be placed in critical areas. Nonfrost susceptible soils should be used at the finished grade to the depth of frost penetration when the finished grade serves as a load-bearing surface.

(2) Additives, such as calcium chloride, can be used to lower the freezing temperature of soil water, but such additives will ordinarily also change the compaction and water content requirements. Therefore, additives must not be used without prior investigation to determine their effect on compaction and water content requirements. Dry sand or sand-gravel mixtures can be placed satisfactorily when temperatures are below freezing without serious effects.

(3) Protection must be provided for in-place permanent backfill in critical areas, such as those around and under structures and embedded items already placed. To preclude structural damage from possible frost heave, backfill materials around such structures should be insulated with a protective covering of mulch, hay, or straw. In some instances, loose lifts of soil can be used for insulation. However, rock or sand is too porous to provide sufficient insulation and too permeable to resist water penetration. If soil is to be used as an insulating material, a material completely foreign to the permanent fill, such as straw or building paper, should be laid down prior to placement of the insulation fill so that there will be a marked distinction between the permanent and the temporary insulation fills. In this way, when the insulation fill is removed, the stripping limits can be readily discerned.

(4) Flooding of the excavation has also been used successfully to prevent frost penetration of the in-place permanent backfill. However, consideration must be given to possible detrimental effects of saturating in-place backfill and the delay of removing the water at the beginning of the next construction season if it freezes into a solid mass of ice.

(5) Concrete walls and floors of completed structures provide poor insulation for the fill around and beneath these structures. Therefore, these structures should be enclosed as much as possible and kept closed during the winter when construction is halted because of adverse freezing weather. Reinforcing steel protruding from a partially completed structure will conduct cold through the concrete and increase the rate and depth of frost penetration beneath the structure.

Every effort should be made to schedule construction so that this condition will be kept to a minimum, and protection must be required where necessary.

i. Seismic zones. The design considerations for subsurface structures subjected to dynamic loads caused by seismic activity or explosive devices are beyond the scope of this manual. Design details are provided in TM 5-818-1/AFM 88-3, Chapter 7, and ER 1110-2-1806. Specific problems relating to backfill operations are primarily limited to possible potential for dynamically induced liquefaction. Certain materials are particularly susceptible to liquefaction; these include saturated gravels, sands, silts, and clayey sands and gravel. Where these materials are used as backfill, the potential for liquefaction can be minimized by requiring a high degree of compaction, particularly in critical areas such as beneath footings and under the spring line of curved wall structures. The requirements for materials susceptible to liquefaction are discussed in paragraph 3-3d.

2-4. Instrumentation. For important structures of unique design or for structures where the potential for postconstruction distress exists, instrumentation of the structure should be considered. The instrumentation program may include monitoring the amount and rate of settlement, movement of retaining walls and other structural elements, development of stresses within the structure, and development of hydrostatic and earth pressures against the structure. Analysis of the data will furnish a check on design assumptions and indicate what measures must be taken to relieve or correct undesirable conditions before distress develops. Information of this nature can also be of significant value in future design and construction.

a. Requirements. Specific requirements for instruments are ruggedness, reliability over the projected service life, and simplicity of construction, installation, and observation. Other important considerations in selecting the type of instruments are cost and availability. Manufacturers of devices considered for installation should be asked to provide a list of projects on which their devices have been installed, and previous users of new equipment should be contacted to ascertain their operating experiences.

b. Installation and observation of instrumentation. A rational instrumentation program must use the proper type of instruments and have the instruments installed properly at critical locations. Valid readings often depend on techniques and procedures used in installing and observing the instrumentation.

(1) Schedules for observations are generally established by the design office. Initial observations should be checked to assure their validity and accuracy, since

these readings usually form the basis to which subsequent observations are related. Observations should be plotted immediately after each set of readings is taken and evaluated for reasonableness against previous sets of readings. In this way, it is often possible to detect errors in readings and to obtain check readings before significant changes in field conditions occur.

(2) EM 1110-2-1908 discusses in detail various types of instrumentation devices; procedures for installation, observation, and maintenance; collection, recording, analysis, and reporting of data; and possible source of error and causes of malfunctions.

2-5. Optimum cost construction. The designer should consider all details of the construction process to ensure a safe and operational facility at the lowest possible cost.

a. Energy requirements. The consideration of energy requirements is important not only for economical reasons but also for the critical need to conserve energy wherever possible. It should not be the intent of the design engineer to unduly restrict the competitive nature of current contractual procedures. Nevertheless, there are certain alternatives that the designer may specify that potentially could lead to more energy efficient construction with cost saving being reflected in bid prices. Some of the possible alternatives that should be considered are discussed below.

(1) Sources of suitable select backfill material should be located as close to the project site as possible. The source may be either a borrow area or a commercial vendor.

(2) Hauling routes to and from the source of backfill and the project site should follow the most direct route.

(3) Only compaction equipment that will compact the specific backfill to the required density in an efficient manner should be approved for use. For large projects, the designer may require that the contractor demonstrate the capabilities of the equipment he intends to use prior to construction.

(4) If possible, material from excavations or within the immediate vicinity of the project site should be used as backfill, even though such material may be marginally suitable. The engineering characteristics of marginal material may be enhanced by the use of additives (para 3-3d).

(5) The energy requirements for adequate cold weather protection of construction personnel and structures can be considerable. For project sites subject to seasonal cold weather, construction should not, if possible, be scheduled during extreme cold weather periods.

b. Value engineering. Potential cost savings may be realized by encouraging the contractor to participate in value engineering, whereby the contractor shares

any project saving derived from realistic cost-saving suggestions submitted.

2-10

CHAPTER 3

EVALUATION, DESIGN, AND PROCESSING
OF BACKFILL MATERIALS

3-1. General. The evaluation, design, and proper processing of backfill materials are extremely important phases of the preconstruction operations. The purpose of the evaluation phase is to determine the engineering characteristics of potential backfill materials. The design phase must take into account the engineering characteristics required of the backfill and specify materials that, when compacted properly, will have these characteristics. Proper processing of the backfill material will ensure that desirable engineering characteristics will be obtained as the material is placed.

3-2. Evaluation of backfill materials. Evaluation of backfill materials consists of exploration, sampling, and laboratory testing to determine the engineering characteristics of potential backfill materials. Detailed instructions for exploration, sampling, laboratory testing, and foundation design are presented in TM 5-818-1/AFM 88-3, Chapter 7. However, to emphasize the need for an adequate investigation, some aspects of planning and investigation that should be considered are discussed in the following paragraphs.

a. Field exploration and sampling. Field exploration and sampling are extremely important to the design of foundations, selection of backfill, and planning for construction. A great amount of material will be available from required excavations, and the investigation for foundation conditions should include the sampling and evaluation of these materials for possible use as backfill. Where an adequate volume of suitable backfill cannot be obtained from the construction excavation, the exploration and sampling program must be expanded to find other sources of suitable material whether from nearby borrow areas or commercial sources.

(1) The purpose of the investigation is to delineate critical conditions and provide detailed information on the subsurface deposits so that proper design and construction, including backfilling operations, can be accomplished with minimum difficulty. Thus careful planning is required prior to the field exploration and sampling phase of the investigation. Available geologic and soil data should be studied, and if possible, preliminary borings should be made. Once a site has been tentatively selected, orientation of the structure to the site should be established. The engineer who

plans the detailed field exploration program must have knowledge of the structure, i.e., its configuration and foundation requirements for design loads and settlement tolerances. The planning engineer should also know the type and quantity of backfill required. The importance of employing qualified field exploration personnel cannot be overemphasized. The exploration crews should be supervised in the field by a soils engineer or geologist familiar with the foundation and backfill requirements so that changes can be made in the exploration program where necessary to provide adequate information on subsurface conditions.

(2) The field engineer should also know the location of significant features of the structure so that sampling can be concentrated at these locations. In addition, he should have an understanding of the engineering characteristics of subsurface soil and rock deposits that are important to the design of the structure and a general knowledge of the testing program so that the proper type and quantity of samples will be obtained for testing.

(3) From the samples, the subsurface deposits can be classified and boring logs prepared. The more continuous the sampling operation, the more accurate will be the boring logs. All borings should be logged with the description of the various strata encountered as discussed in TM 5-818-1/AFM 88-3, Chapter 7. Accurate logging and correct evaluation of all pertinent information are essential for a true concept of subsurface conditions.

(4) When the exploratory borings at the construction site have been completed, the samples and logs of borings should be examined to determine if the material to be excavated will be satisfactory and in sufficient quantity to meet backfill requirements. Every effort should be made to use the excavated materials; however, if the excavated materials are not satisfactory or are of insufficient quantity, additional exploration should be initiated to locate suitable borrow areas. If borrow areas are not available, convenient commercial sources of suitable material should be found. Backfill sources, whether excavation, borrow, or commercial, should contain several times the required volume of compacted backfill.

(5) Groundwater studies prior to construction of subsurface structures are of the utmost importance, since groundwater control is necessary to provide a dry excavation in which construction and backfilling

operations can be properly conducted. Data on groundwater conditions are also essential for forecasting construction dewatering requirements and stability problems. Groundwater studies must consist of investigations to determine: groundwater levels to include any seasonal variations and artesian conditions; the location of any water-bearing strata; and the permeability and flow characteristics of water-bearing strata. Methods for investigating groundwater conditions are described in TM 5-818-1/AFM 88-3, Chapter 7, and TM 5-818-5/NAVFAC P-418/AFM 88-5, Chapter 6.

b. Laboratory testing. The design of any foundation is dependent on the engineering characteristics of the supporting media, which may be soil or rock in either its natural state or as compacted backfill. The laboratory testing program will furnish the engineer information for planning, designing, and constructing subsurface structures. Laboratory testing programs usually follow a general pattern and to some extent can be standardized, but they should be adapted to particular problems and soil conditions. Special tests and research should be utilized when necessary to develop needed information. The testing program should be well planned with the engineering features of the structure and backfill in mind; testing should be concentrated on samples from areas where significant features will be located but should still present a complete picture of the soil and rock properties. The laboratory test procedures and equipment are described in TM 5-818-1/AFM 88-3, Chapter 7, EM 1110-2-1906, and MIL-STD-621.

(1) *Identification and classification of soils.* The Unified Soil Classification System used for classifying soils for military projects (MIL-STD-619 and TM 5-818-1/AFM 88-3, Chap. 7) is a means of identifying a soil and placing it in a category of distinctive engineering properties. Table 3-1 shows the properties of soil groups pertinent to backfill and foundations. Using these characteristics, the engineer can prepare preliminary designs based on classification and plan the laboratory testing program intelligently and economically.

(a) The Unified Soil Classification System classifies soils according to their grain-size distribution and plasticity characteristics and groups them with respect to their engineering behavior. With experience, the plasticity and gradation properties can be estimated using simple, expedient tests (see table 2-2 and 2-3 of TM 5-818-1/AFM 88-3, Chap. 7 or AFM 89-3, Chap. 2) and these estimates can be confirmed using simple laboratory tests. The principal laboratory tests performed for classification are grain-size analyses and Atterberg limits.

(b) The engineering properties in table 3-1 are based on "Standard Proctor" (CE 25) maximum

density except that the California Bearing Ratio (CBR) and the subgrade modulus are based on CE 55 maximum density. This information can be used for initial design studies. However, for final design of important structures, laboratory tests are required to determine actual performance characteristics, such as CE 55 compaction properties, shear strength, permeability, compressibility, swelling characteristics, and frost susceptibility where applicable, under expected construction conditions.

(c) The Unified Soil Classification System is particularly useful in evaluating, by visual examination, the suitability of potential borrow materials for use as compacted backfill. Proficiency in visual classification can be developed through practice by comparing estimated soil properties with results of laboratory classification tests.

(2) *Compaction testing.* Compaction test procedures are described in detail in MIL-STD-621 and ASTM D 1557 (app. A). It is important that the designer and field inspection personnel understand the basic principles and fundamentals of soil compaction. The principles of soil compaction are discussed in appendix B of this manual.

(a) The purpose of the laboratory compaction tests are to determine the compaction characteristics of available backfill materials. Also, anticipated field density and water content can be approximated in laboratory-compacted samples in order that other engineering properties, such as shear strength, compressibility, consolidation, and swelling, can be studied. For most soils there is an optimum water content at which a maximum density is obtained with a particular compaction effort. A standard five-point compaction curve relating density and water content (fig. B-1, app. B) can be developed by the procedures outlined in MILSTD-621.

(b) The impact compaction test results normally constitute the basis on which field compaction control criteria are developed for inclusion in the specifications. However, for some cohesionless soils, higher densities can be obtained by the vibratory compaction method (commonly referred to as maximum relative density), described in appendix XII of EM 1110-2-1906. The required field compaction is generally specified as a percentage of laboratory maximum dry density and referred to as percent CE 55 maximum density. Water content is an important controlling factor in obtaining proper compaction. The required percentage of maximum dry density and the compaction water content should be selected on the basis of the engineering characteristics, such as compression moduli, settlement, and shear strength, desired in the compacted backfill. It should be noted that these characteristics could be adversely effected by subsequent increases in

water content after placement. This situation could result from an increase in the groundwater level after construction.

(c) Density control of placed backfill in the field can be facilitated by the use of rapid compaction check tests (para 7-5c). A direct rapid test is the one-point impact compaction test. Rapid indirect tests, such as the Proctor needle penetration for cohesive soils or the tone resistance load for cohesionless soils, can also be used when correlations with CE 55 maximum density have been established.

(3) *Shear strength testing.* When backfill is to be placed behind structure walls or bulkheads or as foundation support for a structure, and when fills are to be placed with unrestrained slopes, shear tests should be performed on representative samples of the backfill materials compacted to expected field densities and water contents to estimate as-constructed shear strengths. The appropriate type of test required for the conditions to be analyzed is presented in TM 5-818-1/AFM 88-3, Chapter 7. Procedures for shear strength testing are described in EM 1110-2-1906.

Table 3-1. Typical Engineering Properties of Compacted Materials ^a

Group Symbol	Soil Type	Range of Maximum Dry Unit Weight, pcf	Range of Optimum Water Content Percent	Typical Value of Compression		Typical Strength Characteristics					Range of Subgrade Modulus k lb/cu in.	Potential Frost Action ^b
				At 2.5 ksf (20 psi) Percent of Original Height	At 7.2 ksf (50 psi) Height	Cohesion (As Compacted) psf	Cohesion (Saturated) psf	φ (Effective Stress Envelope) deg	Typical Coefficient of Permeability ft/min	Range of CBR Values		
GW	Well-graded clean gravels, gravel-sand mixtures	125-135	11-8	0.3	0.6	0	0	>38	5 x 10 ⁻²	40-80	300-500	None to very slight
GP	Poorly graded clean gravels, gravel-sand mix	115-125	14-11	0.4	0.9	0	0	>37	10 ⁻¹	30-60	250-400	None to very slight
GM	Silty gravels, poorly graded gravel-sand-silt	120-135	12-8	0.5	1.1	--	--	>34	>10 ⁻⁶	20-60	100-400	Slight to medium
GC	Clayey gravels, poorly graded gravel-sand-clay	115-130	14-9	0.7	1.6	--	--	>31	>10 ⁻⁷	20-40	100-300	Slight to medium
SW	Well-graded clean sands, gravelly sands	110-130	16-9	0.6	1.2	0	0	38	>10 ⁻³	20-40	200-300	None to slight
SP	Poorly graded clean sands, sand-gravel mix	100-120	21-12	0.8	1.4	0	0	37	>10 ⁻³	10-40	200-300	None to slight
SM	Silty sands, poorly graded sand-silt mix	110-125	16-11	0.8	1.6	1050	420	34	5 x 10 ⁻⁵	10-40	100-300	Slight to medium
SM-SC	Sand-silt clay mix with slightly plastic fines	110-130	15-11	0.8	1.4	1050	300	33	2 x 10 ⁻⁶	--	--	--
SC	Clayey sands, poorly graded sand-clay mix	105-125	19-11	1.1	2.2	1550	230	31	5 x 10 ⁻⁷	5-20	100-300	Slight to high
ML	Inorganic silts and clayey silts	95-120	24-12	0.9	1.7	1400	190	32	10 ⁻⁵	15 or less	100-200	Medium to very high
ML-CL	Mixture of inorganic silt and clay	100-120	22-12	1.0	2.2	1350	460	32	5 x 10 ⁻⁷	--	100-200	--
CL	Inorganic clays of low to medium plasticity	95-120	24-12	1.3	2.5	1800	270	28	10 ⁻⁷	15 or less	50-200	Medium to high
OL	Organic silts and silt-clays, low plasticity	80-100	33-21	--	--	--	--	--	--	5 or less	50-100	Medium to high
MH	Inorganic clayey silts, elastic silts	75-95	40-24	2.0	3.8	1500	420	25	5 x 10 ⁻⁷	10 or less	50-100	Medium to very high
CH	Inorganic clays of high plasticity	80-105	36-19	2.6	3.9	2150	230	19	10 ⁻⁷	15 or less	50-150	Medium
OH	Organic clays and silty clays	75-100	45-21	--	--	--	--	--	--	5 or less	25-100	Medium

- Notes:
1. All properties are for condition of "standard Proctor" maximum density, except values of k and CBR which are for CE55 maximum density.
 2. Typical strength characteristics are for effective strength envelopes and are obtained from USER data.
 3. Compression values are for vertical loading with complete lateral confinement.
 4. (>) indicates that typical property is greater than the value shown. (-) indicates insufficient data available for an estimate.

^a After DM-7.

^b From TM 5-18-2/AP 88-6. Chapter 4.

(4) *Consolidation and swell testing.* The rate and magnitude of consolidation under a given load are influenced primarily by the density and type of soil and the conditions of saturation and drainage. Fine grained soils generally consolidate more and at a slower rate than coarse-grained soils. However, poorly graded, granular soils and granular soils composed of rounded particles will often consolidate significantly under load but usually at a relatively fast rate.

(a) The procedure for the consolidation test is outlined in EM 1110-2-1906. The information obtained in this test can be used in settlement analyses to determine the total settlement, the time rate of settlement, and the differential settlement under varying loading conditions. Consolidation characteristics are important considerations in selection of backfill materials. The results of consolidation tests performed on laboratory compacted specimens of backfill material can be used in determining the percent compaction to be required in the specifications.

(b) Swelling characteristics can be determined by a modified consolidation test procedure. The degree of swelling and swelling pressure should be determined on all backfill and foundation materials suspected of having swelling characteristics. This fact is particularly important when a considerable overburden load is removed by excavation or when the compacted backfill with swelling tendencies may become saturated upon removal of the dewatering system and subsequent rise of the groundwater level. The results of swelling tests can be used to determine the suitability of material as backfill. When it is necessary to use backfill materials that have a tendency to swell upon saturation because more suitable materials are unavailable, the placement water content and density that will minimize swelling can be determined from a series of tests. TM 5-818-1/AFM 88-3, Chapter 7, and FHWA-RD-79-51 (app. A) provide further information applicable to compacted backfills.

(5) *Permeability tests.* Permeability tests to determine the rate of flow of water through a material can be conducted in the laboratory by procedures described in EM 1110-2-1906. Permeability characteristics of fine-grained materials at various densities can also be determined from consolidation tests.

(a) Permeability characteristics for the design of permanent drainage systems for structures founded below the groundwater level must be obtained from laboratory tests. The tests should be performed on representative specimens of backfill materials compacted in the laboratory to densities expected in the field.

(b) In situ material permeability characteristics for the design of construction excavation dewatering systems can also be approximated from laboratory tests on representative undisturbed samples. Laboratory permeability tests on undisturbed samples are less expensive than in situ pumping tests performed in the

field; however, laboratory tests are less accurate in predicting flow characteristics.

(6) *Slake durability of shales.* Some clay shales tend to slake when exposed to air and water and must be protected immediately after they are exposed. The extent of slaking also governs the manner in which they are treated as a backfill material (para 3-3c). Slaking characteristics can be evaluated by laboratory jar-slake tests or slake-durability tests.

(a) The jar-slake test is qualitative with six descriptive degrees of slaking determined from visual observation of oven-dried samples soaked in tap water for as long as 24 hours. The jar-slake test is not a standardized test. One version of the jar-slake test is discussed in FHWA-RD-78-141. Six suggested values of the jar-slake index I_j , are listed below:

I_j	Behavior
1	Degrades into pile of flakes or mud
2	Breaks rapidly and forms many chips
3	Breaks rapidly and forms few chips
4	Breaks slowly and forms several fractures
5	Breaks slowly and develops few fractures
6	No change

Shales with I_j values of 1 to 3 should be protected when occurring in excavated slopes and compacted as soil if used for backfill.

(b) The slake-durability test is a standardized test that gives a quantitative description in percent by weight of material remaining intact at the conclusion of the test. Details of the test are presented in FHWA-RD-78-141.

(7) *Dynamic tests for special projects.* The dynamic analysis of projects subject to seismic or blast induced loading conditions requires special dynamic tests on both in situ and backfill materials. Tests required for dynamic analysis include: cyclic triaxial tests; in situ density measurements; and tests to determine shear wave velocities, shear modulus, and damping (ER 1110-2-1806).

(8) *In situ water content.* The in situ water content, including any seasonal variation, must be determined prior to construction for materials selected for use as backfill. Natural in situ water contents will determine the need for wetting or drying the backfill material before placement to obtain near optimum water contents for placement and compaction. ASTM D 2216 discusses the test method for determining water content.

3-3. Selection of backfill materials. Selection of backfill materials should be based upon the engineering properties and compaction characteristics of the materials available. The results of the field exploration and laboratory test programs should provide adequate information for this purpose. The materials

may come from required excavation, adjacent borrow pits, or commercial sources. In selecting materials to be used, first consideration should be given to the maximum use of materials from required excavation. If the excavated materials are deficient in quality or quantity, other sources should be considered. Common backfill having the desired properties may be found in borrow areas convenient to the site, but it may be necessary to obtain select backfill materials having particular gradation requirements, such as filter sands and gravels and pipe or conduit bedding materials from commercial sources.

a. Primary considerations. Primary considerations for borrow material sources are suitability and quantity. Accessibility and proximity of the borrow area to the jobsite should also be considered. The water contents of the borrow area material should be determined seasonally, and a source of water should be located if the natural water contents are considerably less than the required placement water content. If several sources of suitable backfill are available, other factors to be considered in selecting the borrow materials are ease of loading and spreading and the means for adding or reducing water. The need for separating or mixing soil strata from excavation or borrow sources should be considered if necessary to provide reasonably uniform engineering properties throughout the compacted backfill.

b. Compaction characteristics. If compaction characteristics of the major portion of the backfill are relatively uniform, problems of controlling placement of backfill will be significantly reduced since the inspector will be able to develop more rapidly the ability to recognize the adequacy of the compaction procedures. In addition, the frequency of testing for compaction control could be reduced. When available backfill materials are unusual, test sections of compacted backfill are sometimes justified to develop placement procedures and to determine the engineering characteristics to be expected in field-compacted materials.

c. Workability. An important factor in choosing backfill materials is the workability or ease with which the soil can be placed and compacted. Material characteristics that effect workability include: the ease of adjusting water contents in the field by wetting or aeration; the sensitivity to the compaction water content with respect to optimum; and the amount of compaction effort required to achieve specified densities.

d. Types of backfill material. A discussion of the many types of backfill and their compaction characteristics is beyond the scope of this manual since soil types will vary on each project. However, the compaction characteristics of several rather broad categories of backfill (table 3-1) are discussed briefly. MIL STD-619 should be studied

for more detailed information.

(1) Coarse-grained soils. Coarse-grained soils include gravelly and sandy soils and range from clayey sands (SC) through the well-graded gravels of gravelsand mixtures (GW) with little or no fines (table 3-1). They will exhibit slight to no plasticity. All of the wellgraded soils falling in this category have fairly good compaction characteristics and when adequately compacted provide good backfill and foundation support.

(a) One difficulty that might arise with soils in this category would be in obtaining good compaction of the poorly graded sands and gravels. These poorly graded materials may require saturation with downward drainage and compaction with greater compaction effort to achieve sufficiently high densities. Also, close control of water content is required where silt is present in substantial amounts. Coarse-grained materials compacted to a low relative density are susceptible upon saturation to liquefaction under dynamic loads.

(b) For sands and gravelly sands with little or no fines, good compaction can be achieved in either the air-dried or saturated condition. Downward drainage is required to maintain seepage forces in a downward direction if saturation is used to aid in compaction. Consideration may be given to the economy of adding cement to stabilize moist clean sands that are particularly difficult to compact in narrow confined areas. However, the addition of cement may produce zones with greater rigidity than untreated adjacent backfill and form "hard spots" resulting in nonuniform stresses and deformations in the structure.

(c) Cohesionless materials are well suited for placement in confined areas adjacent to and around structures where heavy equipment is not permitted and beneath and around irregularly shaped structures, such as tunnels, culverts, utilities, and tanks. Clean, granular, well-graded materials having a maximum size of 1 inch with 95 percent passing the No. 4 sieve and 5 percent or less passing the No. 200 sieve are excellent for use in these zones. However, a danger exists of creating zones where seepage water may accumulate and saturate adjacent cohesive soils resulting in undesirable consolidation or swelling. In such cases, provisions for draining the granular backfill, sealing the surface, and draining surface water away from the structure are necessary.

(2) Fine-grained soils of low to medium plasticity. In organic clays (CL) of low to medium plasticity (gravelly, sandy, or silty clays and lean clays) and inorganic silts and very fine sands (ML) of low plasticity (silty or clayey fine sands and clayey silts) are included in this category. The inorganic clays are relatively impervious and can be compacted fairly easily with heavy compaction

equipment to provide a good stable backfill. Soils in the CL group can be compacted in confined areas to a fairly high degree of compaction with proper water content and lift thickness control. The clayey sands of the SC group and clayey silts of the ML group can be compacted to fairly high densities, but close control of water content is essential and sometimes critical, particularly on the wet side of optimum water content. Some ML soils, if compacted on the dry side of optimum, may lose considerable strength upon saturation after compaction. Considerable settlement may occur. Caution must therefore be exercised in the use of such soils as backfill, particularly below the groundwater level. Also, saturated ML soils are likely to be highly susceptible to liquefaction when dynamically loaded. Where such soils are used as backfill in seismic prone areas, laboratory tests should be conducted to determine their liquefaction potential (see para. 17-5 and 17-6, TM 5-818-1/AFM 88-3, Chap. 7).

(3) *Rock*. The suitability of rock as backfill material is highly dependent upon the gradation and hardness of the rock particles. The quantity of hard rock excavated at most subsurface structure sites is relatively small, but select cohesionless materials may be difficult to find or may be expensive. Therefore, excavated hard rock may be specified for crusher processing and used as select cohesionless material.

(4) *Shale*. Although shale is commonly referred to as rock, the tendency of some shales to breakdown under heavy compaction equipment and slake when exposed to air or water after placement warrants special consideration.

(a) Some soft shales break down under heavy compaction equipment causing the material to have entirely different properties after compaction than it had before compaction. This fact should be recognized before this type of material is used for backfill. Establishing the proper compaction criteria may require that the contractor construct a test fill and vary the water content, lift thickness, and number of coverages with the equipment proposed for use in the backfill operation. This type of backfill can be used only in unrestricted open zones where heavy towed or self-propelled equipment can operate.

(b) Some shales have a tendency to break down or slake when exposed to air. Other shales that appear rock-like when excavated will soften or slake and deteriorate upon wetting after placement as rockfill. Alternate cycles of wetting and drying increases the slaking process. The extent of material breakdown determines the manner in which it is treated as a backfill material. If the material completely degrades into constituent particles or small chips and flakes, it must be treated as a soil-like material with property characteristics similar to ML, CL, or CH materials, depending upon the intact composition of the parent material. Complete degradation can be facilitated by alternately wetting, drying, and dishing the material before

compaction. A detailed discussion on the treatment of shales as a fill material is given in FHWA-RD-78-141.

(5) *Marginal materials*. Marginal materials are these materials that because of either their poor compaction, consolidation, or swelling characteristics would not normally be used as backfill if sources of suitable material were available. Material considered to be marginal include fine-grained soils of high plasticity and expansive clays. The decision to use marginal materials should be based on economical and energy conservation considerations to include the cost of obtaining suitable material whether from a distant borrow area or commercial sources, possible distress repair costs caused by use of marginal material, and the extra costs involved in processing, placing, and adequately compacting marginal material.

(a) The fine-grained, highly plastic materials make poor backfill because of the difficulty in handling, exercising water-content control, and compacting. The water content of highly plastic finegrained soils is critical to proper compaction and is very difficult to control in the field by aeration or wetting. Furthermore, such soils are much more compressible than less-plastic and coarse-grained soils; shear strength and thus earth pressures may fluctuate between wide limits with changes in water content; and in cold climates, frost action will occur in fine-grained soils that are not properly drained. The only soil type in this category that might be considered suitable as backfill is inorganic clay (CH). Use of CH soils should be avoided in confined areas if a high degree of compaction is needed to minimize backfill settlement or to provide a high compression modulus.

(b) The swelling (and shrinking) characteristics of expansive clay vary with the type of clay mineral present in the soil, the percentage of that clay mineral, and the change in water content. The active clay minerals include montmorillonite, mixed-layer combinations of montmorillonite and other clay minerals, and under some conditions chlorites and vermiculites. Problems may occur from the rise of groundwater, seepage, leakage, or elimination of surface evaporation that may increase or decrease the water content of compacted soil and lead to the tendency to expand or shrink. If the swelling pressure developed is greater than the restraining pressure, heave will occur and may cause structural distress. Compaction on the wet side of optimum moisture content will produce lower magnitudes of swelling and swell pressure. Expansive clays that exhibit significant volume increases should not be used as backfill where the potential for structural damage might exist. Suitability should be based upon laboratory swell tests (TM 5-818-1/AFM 88-3, Chapter 7).

(c) Additives, such as hydrated lime, quicklime, and fly ash, can be mixed with some highly plastic clays to improve their engineering characteristics and permit the use of some materials that would otherwise be unacceptable. Hydrated lime can also be mixed with some expansive clays to reduce their swelling characteristics (TM 5-818-1/AFM 88-3, Chapter 7). Laboratory tests should be performed to determine the amount of the additive that should be used and the characteristics of the backfill material as a result of using the additive. Because of the complexity of soil-additive systems and the almost complete empirical nature of the current state of the art, trial mixes must be varied in the field by test fills.

(6) *Commercial by-products.* The use of commercial by-products, such as furnace slag or fly ash as backfill material, may be advantageous where such products are locally available and where suitable natural materials cannot be found. Fly ash has been used as a lightweight backfill behind a 25-foot-high wall and as an additive to highly plastic clay. The suitability of these materials will depend upon the desirable characteristics of the backfill and the engineering characteristics of the products.

3-4. Processing of backfill materials. The construction of subsurface structures often requires the construction of elements of the structure within or upon large masses of backfill. The proper functioning of these elements are often critically affected by adverse behavioral characteristics of the backfill. Behavioral characteristics are related to material type, water content during compaction, gradation, and compaction effort. While compaction effort may be easily controlled

during compaction, it is difficult to control material type, water content, and gradation of the material as it is being placed in the backfill; control criteria must be established prior to placement.

a. Material type. Backfill material should consist of a homogeneous material of consistent and desirable characteristics. The field engineer must ensure that only the approved backfill material is used and that the material is uniform in nature and free of any anomalous material such as organic matter or clay pockets. Stratified material should be mixed prior to placing to obtain a uniform blend. Excavated material to be used as backfill should be stockpiled according to class or type of material.

b. Water content. While water content can be adjusted to some extent after placing (but before compacting), it is generally more advantageous to adjust the water content to optimum compaction conditions before placing. Adjustment of water content can be accomplished by aeration (disking or turning) or sprinkling the material in 12- to 18-inch layers prior to placing or stockpiling. If the material is stockpiled, provisions should be made to maintain a constant moisture content during wet or dry seasons.

c. Ensuring gradation. Some backfill materials consisting of crushed rock, gravel, or sand require limitations on maximum and minimum particle-size or gradation distributions. Where materials cannot be located that meet gradation criteria, it may be advantageous to require processing of available material by sieving to obtain the desired gradation.

CHAPTER 4

EARTHWORK: EXCAVATION AND PREPARATION FOR FOUNDATIONS

4-1. Excavation.

a. General. In general, excavation for subsurface structures will consist of open excavation and shaft and tunnel excavation. Where excavation to great depths is required, a variety of soils and rock may be encountered at a single site. Soils may range through a wide spectrum of textures and water contents. Rock encountered may vary from soft rock, very similar to a firm soil in its excavation requirements, to extremely hard rock requiring extensive blasting operations for removal. Groundwater may or may not be present. The groundwater conditions and the adequacy of groundwater control measures are important factors in excavation, in maintaining a stable foundation, and in backfilling operations. The extent to which groundwater can be controlled also influences the slopes to which the open excavation can be cut, the bracing required to support shaft and tunnel excavation, and the handling of the excavated material.

b. Good construction practices, and problems. A majority of the problems encountered during excavation are related to groundwater conditions, slope stability, and adverse weather conditions. Many of the problems can be anticipated and avoided by preconstruction planning and by following sound construction practices.

(1) *Groundwater.* Probably the greatest source of problems in excavation operations is groundwater. If the seepage of groundwater into an excavation is adequately controlled, other problems will generally be minor and can be easily handled. Several points should be recognized that, if kept in mind, will help to reduce problems attributable to groundwater. In some instances, groundwater conditions can be more severe than indicated by the original field exploration investigation since field explorations provide information only for selected locations and may not provide a true picture of the overall conditions.

(a) If groundwater seepage begins to exceed the capacity of the dewatering system, conditions should not be expected to improve unless the increased flow is known to be caused by a short-term condition such as heavy rain in the area. If seepage into the excavation becomes excessive, excavation operations should be halted until the necessary corrective measures are determined and effected. The design and evaluation of dewatering systems require considerable experience

that the contractor or the contracting office often do not possess, and the assistance of specialists in this field should be obtained.

(b) Groundwater without significant seepage flow can also be a problem since excess hydrostatic pressures can develop below relatively impervious strata and cause uplift and subsequent foundation or slope instability. Excess hydrostatic pressures can also occur behind sheet pile retaining walls and shoring and bracing in shaft and tunnel excavations. Visual observations should be made for indications of trouble, such as uncontrolled seepage flow, piping of material from the foundation or slope, development of soft wet areas, uplift of ground surface, or lateral movements.

(c) Accurate daily records should be kept of the quantity of water removed by the dewatering system and of the piezometric levels in the foundation and beneath excavation slopes. Separate records should be kept of the flow pumped by any sump-pump system required to augment the regular dewatering system to note any increase of flow into the excavation. Flowmeters or other measuring devices should be installed on the discharge of these systems for measurement purposes (TM 5-818-5/NAVFAC P-418/AFM 88-5, Chap. 6). These records can be invaluable in evaluating "Changed Condition" claims submitted by the contractor. The contractor should be required to have "standby" equipment in case the original equipment breaks down.

(2) *Surface water.* Sources of water problems other than groundwater are surface runoff into the excavation and snow drifting into the excavation. A peripheral, surface-drainage system, such as a ditch and berm, should be required to collect surface water and divert it from the excavation. In good weather there is a tendency for the contractor to become lax in maintaining this system and for the inspection personnel to become lax in enforcing maintenance. The result can be a sudden filling of the excavation with water during a heavy rain and consequent delay in construction. The surface drainage system must be constantly maintained until the backfill is complete. Drifting snow is a seasonal and regional problem, which can best be controlled by snow fences placed at strategic locations around the excavation.

(3) *Slope integrity.* Another area of concern during excavation is the integrity of the excavation

slopes. The slopes may be either unsupported or supported by shoring and bracing. The lines and grades indicated in the plans should be strictly adhered to. The contractor may attempt to gain additional working room in the bottom of the excavation by steepening the slopes; this change in the plans must not be allowed.

(a) Where shoring and bracing are necessary to provide a stable excavation, and the plans and specifications do not provide details of these requirements, the contractor should be required to submit the plans in sufficient detail so that they can be easily followed and their adequacy checked. The first principle of excavation stabilization, using shoring and bracing, is that the placing of supports should proceed with excavation. The excavation cut should not be allowed to yield prior to placing of shoring and bracing since the lateral pressures to be supported would generally be considerably greater after yield of the unshored cut face than if no movement had occurred prior to placement of the shoring. Excavation support systems are discussed in TM 5-818-1/AFM 88-3, Chapter 7. All safety requirements for shoring and bracing as contained in EM 385-1-1 should be strictly enforced.

(b) The inspector must be familiar with stockpiling requirements regarding the distance from the crest of the excavation at which stockpiles can be established and heavy equipment operated without endangering the stability of the excavation slopes. He must also know the maximum height of stockpile or weight of equipment that can be allowed at this distance.

(c) Excessive erosion of the excavation slopes must not be permitted. In areas subject to heavy rainfall, it may be necessary to protect excavation slopes with polyethylene sheeting, straw, silt fences, or by other means to prevent erosion. Excavation slopes for large projects that will be exposed for several seasons should be vegetated and maintained to prevent erosion.

(4) *Stockpiling excavated material.* Generally, procedures for stockpiling are left to the discretion of the contractor. Prior to construction, the contractor must submit his plans for stockpiling to the contracting officer for approval. In certain cases, such as where there are different contractors for the excavation and the backfill phases, it may be necessary to include the details for stockpiling operations in the specifications. In either case, it is important that the stockpiling procedures be conducive to the most advantageous use of the excavated materials.

(a) As the materials are excavated, they should be separated into classes of backfill and stockpiled accordingly. Thus the inspection personnel controlling the excavation should be qualified to classify the material and should be thoroughly familiar with backfill re-

quirements. Also, as the materials are placed in stockpiles, water should be added or the materials should be aerated as required to approximate optimum water content for compaction. Field laboratory personnel can assist in determining the extent to which this is necessary. The requirements of shaping the stockpile to drain and sealing it against the entrance of undesirable water by rolling with spreading equipment or covering with polyethylene sheeting should be enforced. This step is particularly important for cohesive soils that exhibit poor draining characteristics and tend to remain wet if once saturated by rains. Stockpiles must be located over an area that is large enough to permit processing and where they will not interfere with peripheral drainage around the excavation and will not overload the slopes of the excavation.

(b) In cases where significant energy and cost saving can be realized, special stockpiling requirements should be implemented. An example would be a large project consisting of a number of excavation and backfilling operations. The excavation material from the first excavation could be stockpiled for use as backfill in the last excavation. The material from the intermediate excavations could in turn be immediately used as backfill for the first, second, etc., phases of the project and thereby eliminate double handling of excavated backfill for all but the first-phase excavation.

(5) *Protection of exposed material.* If materials that are exposed in areas, such as walls of a silo shaft, foundation support, or any other area against which concrete will be placed, are susceptible to deterioration or swell when exposed to the weather, they should be properly protected as soon after exposure as possible.

Depending on the material and protection requirements, this protection may be pneumatic concrete, asphalt spray, or plastic membrane (TM 5-818-1/AFM 88-33, Chap. 7). In the case of a foundation area, the contractor is required to underexcavate leaving a cover for protection, as required, until immediately prior to placement of the structure foundation. Any frost-susceptible materials encountered during excavation should be protected (para 2-3h (3) and (4)) if the excavation is to be left open during an extended period of freezing weather.

(6) *Excavation record.* As the excavation progresses, the project engineer should keep a daily record of the type of material excavated and the progress made. This record would be of value if subsequent claims of "Changed Conditions" are made by the contractor.

4-2. Foundation preparation.

a. General. In this manual, preparation applies to foundations for backfill as well as those for structures to be placed in the excavation. Generally, if proper excavation procedures have been followed, very little

additional preparation will be required prior to backfill placement.

b. Good construction practices, and problems. As mentioned previously, the problems associated with foundation preparation are greatly reduced by following such proper excavation procedures as maintaining a dry excavation and planning ahead. The principles of good foundation preparation are simple, but enforcing the provisions of the specifications concerning the work is more difficult. Inspection personnel must recognize the importance of this phase of the work since, if not properly controlled, problems can result.

(1) It is most important that a stable foundation be provided. Thus it may be necessary, particularly in the case of sensitive fine-grained materials, to require that the final excavation for footings be carefully done with hand tools and that no equipment be allowed to operate on the final cut surface. To provide a working platform on which to begin backfill placement on these sensitive materials, it may be necessary to place an initial layer of granular material.

(2) If the foundation is to be supported on rock, the soundness of the exposed rock should be checked by a slaking test (soaking a piece of the rock in water to determine the resulting degree of deterioration (para 3-2b (6)) and visual observation to determine if the rock is in a solid and unshattered condition. If removal of rock below the foundation level is required, the space should be filled with concrete. A qualified geological or soils engineer should inspect the area if it is suspected that the material will deteriorate or swell when exposed to the weather. If necessary, the materials must be protected from exposure using the methods previously discussed in paragraph 4-1b (5).

(3) Before placement of any structure foundation is begun, the plans should be rechecked to ensure that all required utilities and conduits under or adjacent to the foundation have been placed, so that excavating under or undermining the foundation to place utilities and conduits will not become necessary later.

(4) Occasionally, it may be found upon completion of the excavation that if a structure were placed as shown on the plans, it would be supported on two materials with drastically different consolidation characteristics, such as rock and soil, rock and backfill, or undisturbed soil and backfill. This situation could

occur because the predesign subsurface information was inadequate, because the structure was relocated or reoriented by a subsequent change in the plans, because of an oversight of the design engineer, or because of the excavation procedures followed by the contractor. Regardless of the reason, measures such as overexcavation and placement of subsequent backfill should be taken, where possible, and in coordination with the design office to provide a foundation of uniform material. Otherwise, the design office should evaluate the differences in foundation conditions for possible changes to the structural foundation elements.

(5) Preparing the area to receive the backfill consists of cleaning, leveling, and compacting the bottom of the excavation if the foundation is in soil. All debris and foreign material, such as trash, broken concrete and rock, boulders, and forming lumber, should be removed from the excavation. All holes, depressions, and trenches should be filled with the same material as that specified to be placed immediately above such a depression, unless otherwise designated, and compacted to the density specified for the particular material used. If the depression is large enough to accommodate heavy compacting equipment, the sides of the depression should have a positive slope and be flat enough for proper operation of compaction equipment. After the area is brought to a generally level condition by compacting in lifts in accordance with specifications, the entire area to receive backfill should be sacrificed to the depth specified, the water content adjusted if necessary, and the area compacted as specified. If the foundation is in rock, the area should be leveled as much as possible and all loose material removed.

(6) All work in the excavation should be accomplished in the dry; therefore, the dewatering system should be operated for the duration of this work. Under no circumstances should the contractor be allowed to dry an area by dumping a thick layer of dry material over it to blot the excess water. If soil exists at the foundation level and becomes saturated, it cannot be compacted. The saturated soil will have to be removed and replaced or drained sufficiently so that it can be compacted. Any frozen material in the foundation should be removed before placement of concrete footings or compacted backfill.

CHAPTER 5

BACKFILL OPERATIONS

5-1. Placement of backfill.

a. *General.* Backfill construction is the refilling of previously excavated space with properly compacted material. The areas may be quite large, in which case the backfilling operation will be similar to embankment construction. On the other hand, the areas may be quite limited, such as confined areas around or between and beneath concrete or steel structures and areas in trenches excavated for utility lines. Prior to construction of the backfill, the inspection personnel should become thoroughly familiar with the various classes of backfill to be used. They should be able to readily identify the materials on sight, know where the various types of material should be placed, and be familiar with the compaction characteristics of the soil types. Compaction characteristics of various soil types are discussed in appendix B.

b. *Good construction practices, and problems.* Problems with placement of backfill will vary from one construction project to another. The magnitude of the problems will depend on the type of materials available such as backfill, density requirements, and the configuration of the areas in which compaction is to be accomplished. Problems should be expected during the initial stages of backfill compaction unless the contractor is familiar with compaction characteristics of backfill materials. The inspector can be of great assistance to the contractor during this period by performing frequent water content and density checks. The information from these checks will show the contractor the effects of the compaction procedures being used and point out any changes that should be made.

(1) *Backfilling procedures.* Problems associated with the compaction of backfill can be minimized by following good backfilling procedures. Good backfilling procedures include: processing the material (para. 3-4) before it is placed in the excavation; placing the material in a uniformly spread loose lift of the proper thickness suited to the compaction equipment and the type of material to be used; applying the necessary compaction effort to obtain the required densities; and ensuring that these operations are not performed during adverse weather. Proper bond should be provided between each lift and also between the backfill and the sides of the excavation.

(2) *Compaction equipment, backfill material, and zones.* The type of compaction equipment used to

achieve the required densities will usually depend upon the type of backfill material being compacted and the type of zone in which the material is placed.

(a) In open zones, coarse-grained soils that exhibit slight plasticity (clayey sands, silty sands, clayey gravels, and silty gravels) should be compacted with either sheepsfoot or rubber-tired rollers; close control of water content is required where silt is present in substantial amounts. For sands and gravelly sands with little or no fines, good compaction results are obtained with tractor compaction. Good compaction can also be achieved in gravels and gravel-sand mixtures with either a crawler tractor or rubber-tired and steelwheeled rollers. The addition of vibration to any of the means of compaction mentioned above will usually improve the compaction of soils in this category. In confined zones, adequate compaction of cohesionless soils in either the air-dried or saturated condition can be achieved by vibratory-plate compactors with a static weight of at least 100 pounds. If the material is compacted in the saturated condition, good compaction can be achieved by internal vibration (for example, by using concrete vibrators). Downward drainage is required to maintain seepage forces in a downward direction if the placed material is saturated to aid in compaction.

(b) Inorganic clays, inorganic silts, and very fine sands of low to medium plasticity are fairly easily compacted in open zones with sheepsfoot or rubber-tired rollers in the 15,000-pound and above wheel-load class. Some inorganic clays can be adequately compacted in confined zones using rammer or impact compactors with a static weight of at least 100 pounds provided close control of lift thickness and water content is maintained.

(c) Fine-grained, highly plastic materials, though not good backfill materials, can best be compacted in open zones with sheepsfoot rollers. Sheepsfoot rollers leave the surface of the backfill in a rough condition, which provides an excellent bond between lifts. In confined areas the best results, which are not considered good, are obtained with rammer or impact compactors.

(3) *Lift thickness.* The loose-lift thickness will depend on the type of backfill material and the compaction equipment to be used.

(a) As a general rule, a loose-lift thickness that will result in a 6-inch lift when compacted can be

allowed for most sheepsfoot and pneumatic-tired rollers. Cohesive soils placed in approximately 10-inch loose lifts will compact to approximately 6 inches, and cohesionless soils placed in approximately 8-inch base lifts will compact to 6 inches. Adequate compaction can be achieved in cohesionless materials of about 12- to 15-inch loose-lift thickness if heavy vibratory equipment is used. The addition of vibration to rolling equipment used for compacting cohesive soils generally has little effect on the lift thickness that can be compacted, although compaction to the desired density can sometimes be obtained by fewer coverages of the equipment.

(b) In confined zones where clean cohesionless backfill material is used, a loose-lift thickness of 4 to 6 inches and a vibratory plate or walk-behind, dual-drum vibratory roller for compaction is recommended. Where cohesive soils are used as backfill in confined zones, use of rammer compactors and a loose-lift thickness of not more than 4 inches should be specified. Experience has shown that "two-by-four" wood rammers, or single air tampers (commonly referred to as "powder puffs" or "pogo sticks") do not produce sufficient compaction.

(4) *Density requirements.* In open areas of backfill where structures will not be constructed, compaction can be less than that required in more critical zones. Compaction to 90 percent of CE 55 maximum dry density as obtained by MIL-STD-621 should be adequate in these areas. If structures are to be constructed on or within the backfill, compaction of cohesionless soils to within 95 to 100 percent of CE 55 maximum dry density and of cohesive soils to at least 95 percent of CE 55 should be required for the full depth of backfill beneath these structures. The specified degree of compaction should be commensurate with the tolerable amount of settlement, and the compaction equipment used should be commensurate with the allowable lateral pressure on the structure. Drainage blankets and filters having special gradation requirements should be compacted to within 95 to 100 percent of CE 55 maximum dry density. Table 5-1 gives a summary of type of compaction equipment, number of coverages, and lift thickness for the specified degree of compaction of various soil types (TM 5-818-1/AFM 88-3, Chap. 7).

(5) *Cold weather.* In areas where freezing temperatures either hamper or halt construction during the winter, certain precautions can and should be taken to prevent damage from frost penetration and subsequent thaw. Some of these precautions are presented below.

(a) Placement of permanent backfill should be deferred until favorable weather conditions prevail. However, if placement is an absolute necessity during freezing temperatures, either dry, cohesionless, non

frost-susceptible materials or material containing additives, such as calcium chloride, to lower the freezing temperature of the soil water should be used. Each lift should be checked for frozen material after compaction and before construction of the next lift is begun. If frozen material is found, it should be removed; it should not be disked in place. Additives should not be used indiscriminately since they will ordinarily change compaction and water content requirements. Prior laboratory investigation should be conducted to determine additive requirements and the effect on the compaction characteristics of the backfill material.

(b) Under no circumstances should frozen material, from stockpile or borrow pit, be placed in backfill that is to be compacted to a specified density.

(c) Prior to halting construction during the winter, the peripheral surface drainage system should be checked and reworked where necessary to provide positive drainage of surface water away from the excavation.

(d) Foundations beneath structures and backfill around structures should not be allowed to freeze, because structural damage will invariably develop. Structures should be enclosed as much as possible and heated if necessary. Construction should be scheduled so as to minimize the amount of reinforcing steel protruding from a partially completed structure since steel will conduct freezing temperatures into the foundation.

(e) Permanent backfill should be protected from freezing as discussed in paragraphs 2-3h (3) and (4). Records should be made of all temporary coverings that must be removed before backfilling operations are resumed. A checklist should be maintained to ensure that all temporary coverings are removed at the beginning of the next construction season.

(f) During freezing weather, records should be kept of the elevation of all critical structures to which there is the remotest possibility of damage or movement due to frost heave and subsequent thaw. It is important that frost-free bench marks be established to which movement of any structure can be referenced.

Bench marks also should be established on the structures at strategic locations prior to freezing weather.

(g) At the beginning of the following construction season and after the temporary insulating coverings are removed, the backfill should be checked for frozen material and ice lenses, and the density of the compacted material should be checked carefully before backfilling operations are resumed. If any backfill has lost its specified density because of freezing, it should be removed.

(6) *Zones having particular gradation requirements.* Zones that have particular gradation requirements include those needed to conduct and control seepage, such as drainage blankets, filters, and zones

Table 5-1. Summary of Compaction Criteriaa

Soil Group	Soil Types	Degree of Compaction	Fill and Backfill				
			Equipment	Typical Equipment and Procedures for Compaction No. of Passes or Coverages	Comp. Lift Thick., in.	Placement Water Content	Field Control
Pervious (Free-Draining)	GW GP SW SP	90 to 95% of CE 55 maximum density	Vibratory rollers and compactors	Indefinite	Indefinite	Saturate by flooding	Control tests at intervals to determine degree of compaction or relative density
			Rubber-tired roller ^b	2-5 coverages	12		
		75 to 85% of relative density	Crawler-type tractor ^c	2-5 coverages	8		
			Power hand tamper ^d	Indefinite	6		
	Semi-compacted	85 to 90% of CE 55 maximum density	Rubber-tired roller ^b	2-5 coverages	14	Saturate by flooding	Control tests as noted above, if needed
			Crawler-type tractor ^c	1-2 coverages	10		
Power hand tamper ^d			Indefinite	8			
		65 to 75% of relative density	Controlled routing of construction equipment	Indefinite	8-10		
Semi-pervious and Impervious	GM GC SM SC ML CL OL OH MH CH OH	90 to 95% of CE 55 maximum density	Rubber-tired roller ^b	2-5 coverages	8	Optimum water content	Control tests at intervals to determine degree of compaction
			Sheepsfoot roller ^e	4-8 passes	6		
			Power hand tamper ^d	Indefinite	4		
	Semi-compacted	85 to 90% of CE 55 maximum density	Rubber-tired roller ^b	2-4 coverages	10	(A) Optimum water content (B) By observation; wet side-maximum water content at which material can satisfactorily operate, dry side-minimum water content required to bond particles and which will not result in voids or honeycombed material	(A) Control tests as noted above, if needed (B) Field control exercised by visual inspection of action of compacting equipment
			Sheepsfoot roller ^e	4-8 passes	8		
			Crawler-type tractor ^c	3 coverages	6		
			Power hand tamper ^d	Indefinite	6		
			Controlled routing of construction equipment	Indefinite	6-8		

Note: The above requirements will be adequate in relation to most construction. In special cases where tolerable settlements are unusually small, it may be necessary to employ additional compaction equivalent to 95 to 100 of compaction effort. A coverage consists of one application of the wheel of a rubber-tired roller or the threads of a crawler-type tractor over each point in the area being compacted. For a sheepsfoot roller, one pass consists of one movement of a sheepsfoot roller drum over the area being compacted.

- a Prom TM 5-818-1.
- b Rubber-tired rollers having a wheel load between 18,000 and 25,000 lb and a tire pressure between 80 and 100 psi.
- c Crawler-type tractors weighing not less than 20,000 lb and exerting a foot pressure not less than 6-1/2 psi.
- d Power hand tampers weighing more than 100 lb; pneumatic or operated by gasoline engine.
- e Sheepsfoot rollers having a foot pressure between 250 and 500 psi and tamping feet 7 to 10 in. in length with a face area between 7 and 16 sq in.

susceptible to frost penetration. Drainage zones are often extremely important to the satisfactory construction and subsequent performance of the structure. To maintain the proper functioning of these zones, care must be taken to ensure that the material placed has the correct gradation and is compacted according to specifications.

c. Special problems. In open zones, compaction of backfill will not generally present any particular problems if proper compaction procedures normally associated with the compaction of soils are exercised and the materials available for use, such as backfill, are not unusually difficult to compact. The majority of the problems associated with backfill will occur in confined zones where only small compaction equipment producing a low compaction effort can be used or where because of the confined nature of the backfill zone even small compaction equipment cannot be operated effectively.

(1) Considerable latitude exists in the various types of small compaction equipment available. Unfortunately, very little reliable information is available on the capabilities of the various pieces of equipment. Depending upon the soil type and working room, it may be necessary to establish lift thickness and compaction effort based essentially on trial and error in the field. For this reason, close control must be maintained particularly during the initial stages of the backfill until adequate compaction procedures are established.

(2) Circular, elliptical and arched walled structures are particularly difficult to adequately compact backfill beneath the under side of haunches because of limited working space. Generally, the smaller the structure the more difficult it is to achieve required densities. Rock, where encountered, must be removed to a depth of at least 6 inches below the bottom of the structure and the overdepth backfilled with suitable material before foundation bedding for the structure is placed. Some alternate bedding and backfill placement methods are discussed below.

(a) One method is to bring the backfill to the planned elevation of the spring line using conventional heavy compaction equipment and methods. A template in the shape of the structure to be bedded is then used to reexcavate to conform to the bottom contours of the structure. If the structure is made of corrugated metal, allowance should be made in the grade for penetration of the corrugation crests into the backfill upon application of load. Success of this method of bedding is highly dependent on rigid control of grade during reexcavation using the template. This procedure is probably the most applicable where it is necessary to use a cohesive backfill.

(b) Another method of bedding placement is to sluice a clean granular backfill material into the bed after the structure is in place. This method is particularly

adapted to areas containing a maze of pipes or conduits. Adequate downward drainage, generally essential to the success of this method, can be provided by sump pumps or, if necessary, by pumping from well points. Sluicing should be accompanied by vibrating to ensure adequate soil density. Concrete vibrators have been used successfully for this purpose. This method should be restricted to areas where conduits or pipes have been placed by trenching or in an excavation that provides confining sides. Also, this method should not be used below the groundwater table in seismic zones, since achieving densities high enough to assure stability in a seismic zone is difficult.

(c) Another method is to place clean, granular bedding material with pneumatic concrete equipment under the haunches of pipes, tunnels, and tanks. The material is placed wet and should have an in-place water content of approximately 15 to 18 percent. A nozzle pressure of 40 pounds per square inch is required to obtain proper density. Considerable rebound of material (as much as 25 percent by volume when placed with the hose nozzle pointed vertically downward and 50 percent with the nozzle pointed horizontally) occurs at this pressure. Rebound is the material that bounces off the surface and falls back in a loose state. However, the method is very satisfactory if all rebound material is removed. The material can be effectively removed from the backfill by dragging the surface in the area where material is being placed with a flat-end shovel. Two or three men will be needed for each gunite hose operated.

(d) For structures and pipes that can tolerate little or no settlement, lean grouts containing granular material and various cementing agents, such as portland cement or fly ash, can be used. This grout may be placed by either method discussed in (b) and (c) above.

However, grouts may develop hard spots (particularly where the sluice method is used that could cause segregation of the granular material and the cementing agent), which could generate stress concentrations in rigid structures such as concrete pipes. Stress concentrations may be severe enough to cause structural distress. If lean grouts are used as backfill around a rigid structure, the structure must be designed to withstand any additional stress generated by possible hard spots.

5-2. Installation of Instruments. Installation of instrumentation devices should be supervised, if not actually done, by experienced personnel from within the Corps of Engineers or by firms that specialize in instrumentation installation. The resident engineer staff must be familiar with the planned locations of all instruments and necessary apparatus or structures (such as trenches and terminal houses) so that necessary arrangements and a schedule for installation

can be made with the contractor and with the office or firm that will install the devices. Inspectors should inspect any instrumentation furnished and installed by the contractor. Records must be made of the exact locations and procedures used for installation and initial observations. Inspectors should ensure that necessary extensions are added for the apparatus (such as lead lines and piezometer tubes) installed within the backfill as the backfill is constructed to higher elevations. Care must be used in placing and compacting backfill around instruments that are installed within or through backfill. Where necessary to prevent damage to instruments, backfill must be placed manually and compacted with small compaction equipment such as rammers or vibratory plates.

5-3. Postconstruction distress. Good backfill construction practices and control will minimize the potential for postconstruction distress. Nevertheless, the possibility of distress occurring is real, and measures must be taken to correct any problems before they become so critical as to cause functional problems with the facility. Therefore, early detection of distress is essential. Some early signs of possible distress include: settlement or swelling of the backfill around the structure; sudden or gradual change of instrumentation data; development of cracks in structural walls; and adverse seepage problems. Detailed construction records are important for defining potential distress areas and assessing the mechanisms causing the distress.

CHAPTER 6

SPECIFICATION PROVISIONS

6-1. General.

a. The plans and specifications define the project in detail and show how it is to be constructed. They are the basis of the contractor's estimate and of the construction contract itself. The drawings show the physical characteristics of the structure, and the specifications cover the quality of materials, workmanship, and technical requirements. Together they form the guide and standard of performance that will be required in the construction of the project. Once the contract is let, the plans and specifications are binding on both the Contracting Officer and the contractor and are changed only by written agreement. For this reason, it is essential that the contractor and the Contracting Officer's representative anticipate and resolve differences that may arise in interpreting the intent and requirements of the specifications. The ease with which this can be accomplished will depend on the clarity of the specifications and the background and experience of the individuals concerned. Understanding of requirements and working coordination can be improved if unusual requirements are brought to the attention of prospective bidders and meetings for discussion are held prior to construction. Situations will undoubtedly arise that are not covered by the specifications, or conditions may occur that are different from those anticipated. Close cooperation is required between the contractor and the inspection personnel in resolving situations of this nature; if necessary, to be fair to both parties a change order should be issued.

b. Preparation of contract specifications is easier if an outline of general requirements is available to the specification writer. However, it would be virtually impossible to prepare a guide specification that anticipates all problems that may occur on all projects. Therefore, contract specifications must be written to satisfy the specific requirement of each project. Some alternate specification requirements that might be considered for some projects are discussed below.

6-2. Excavation. The section of the specifications dealing with excavation contains information on drainage, shoring and bracing, removal and stockpiling, and other items, and refers to the plans for grade requirements and slope lines to be followed in excavating overburden soils and rock.

a. *Drainage.* For some projects the specifications

will require the contractor to submit a plan of his excavation operations to the Contracting Officer for review. The plans and specifications will require that the excavation and subsequent construction and backfill be carried out in the dry. To meet this requirement, a dewatering system based on the results of groundwater studies may be included in the plans. Also, for some projects the specifications may require the contractor to submit his plan for controlling groundwater conditions. The specifications should likewise indicate the possibility of groundwater conditions being different from those shown in the subsurface investigation report due to seasonal or unusual variations or insufficient information, since the contractor will be held responsible for controlling the groundwater flow into the excavation regardless of the amount. To this end, the specifications should provide for requiring the contractor to submit a revised dewatering plan for review where the original dewatering plan is found to be inadequate.

b. *Shoring and bracing.* The specifications either will require the contractor to submit for review his plans for the shoring and bracing required for excavation or will specify shoring and bracing required by subsurface and groundwater conditions and details of the lines and grades of the excavation. In the latter case, the contractor may be given the option to submit alternate plans for shoring and bracing for review by the Contracting Officer. The plans will present the necessary information for the design of such a system if the contractor is allowed this option.

c. *Stockpiling.* Provisions for stockpiling materials from required excavation according to type of backfill may or may not be included in the specifications. Generally, procedures for stockpiling are left to the discretion of the contractor, and a thorough study should be made to substantiate the need for stockpiling before such procedures are specified. There are several conditions under which inclusion of stockpiling procedures in the specifications would be desirable and justified. Two such conditions are discussed in the following paragraphs.

(1) Under certain conditions, such as those that existed in the early stages of missile base construction where time was an important factor, it may be necessary or desirable to award contracts for the work in phases. As a result, one contractor may do the excavating

and another place the backfill. It is probable that the excavation contractor will have little or no interest in stockpiling the excavated materials in a manner conducive to good backfilling procedures. When such a situation can be foreseen, the specifications should set forth stockpiling procedures. The justification for such requirements would be economy and optimum use of materials available from required excavation as backfill.

(2) The specifications will contain provisions for removing, segregating, and stockpiling or disposing of material from the excavation and will refer to the plans for locations of the stockpiles. The subsoil conditions and engineering characteristics requirements may state that the specifications must be quite definite concerning segregation and stockpiling procedures so that the excavated materials can be used most advantageously in the backfill. The specification may require that water be added to the material or the material be aerated as it is stockpiled to approximate optimum water content, that the stockpile be shaped to drain and be sealed from accumulation of excess water, and that the end dumping of material on the stockpile be prohibited to prevent segregation of material size or type along the length of the stockpile.

(3) An alternative to this latter action would be to specify the various classes of backfill required and leave the procedure for stockpiling the materials by type to the discretion of the contractor. In this case, the contractor should be required to submit a detailed plan for excavating and stockpiling the material. The plan should indicate the location of stockpiles for various classes of backfill so that the material can be tested for compliance with the specifications. The contractor may elect to obtain backfill material from borrow or commercial sources rather than to separate and process excavated materials. Then the specifications should require that stockpiles of the various classes of needed backfill be established at the construction site in sufficient quantity and far enough in advance of their use to allow for the necessary testing for approval unless conditions are such that approval of the supplier's stockpile or borrow source can be given.

6-3. Foundation preparation. The provisions for preparation for structures will generally not be grouped together in the specifications but will appear throughout the earthwork section of the specifications under paragraphs on excavation, protection of foundation materials, backfill construction, and concrete placement. When a structure is to be founded on rock, the specifications will require that the rock be firm, unshattered by blasting operations, and not deteriorated from exposure to the weather. The contractor will be required to remove shattered or weathered rock and to fill the space with concrete.

a. Specifications for structures founded on soil require the removal of all loose material and all unsuitable material, such as organic clay or silt, below the foundation grade. When doubt exists as to the suitability of the foundation materials, a soils engineer should inspect the area and his recommendations should be followed. When removal of rock material below the planned foundation level is required, the overexcavation will usually require filling with concrete. The specifications also require dewatering to the extent that no backfill or structural foundation is placed in the wet.

b. Specifications for preparation of the soil foundation to receive backfill require removing all debris and foreign matter, making the area generally level, and scarifying, moistening, and compacting the foundation to a specified depth, generally 12 inches. Specific provisions may or may not be given with respect to leveling procedures.

6-4. Backfill operations. The specifications define the type or types of material to be used for backfill construction and provide specific instructions as to where these materials will be used in the backfill. The percentage of CE 55 maximum dry density to be obtained, determined by a designated standard laboratory compaction procedure, will be specified for the various zones of backfill. The maximum loose-lift thickness for placement will also be specified. Because of the shape of the compaction curve (see discussion of compaction characteristics in Section B-1, app. B), the degree of compaction specified can be achieved only within a certain range of water contents for a particular compaction effort. Though not generally specified in military construction, the range of water contents is an important factor affecting compaction.

a. The specifications sometimes stipulate the characteristics and general type of compaction equipment to be used for each of the various types of backfill. Sheepsfoot or rubber-tired rollers, rammer or impact compactors, or other suitable equipment are specified for fine-grained, plastic materials. Noncohesive, freedraining materials are specified to be compacted by saturating the material and operating crawler-type tractor, surface or internal vibrators, vibratory compactors, or other similar suitable equipment. The specifications generally will prohibit the use of rock or rock-soil mixtures as backfill in this type of construction. However, when the use of backfill containing rock is permitted, the maximum size of the rock is given in the specifications along with maximum lift thickness, loading, hauling, dumping, and spreading procedures, type of compaction equipment, and method of equipment operation. The specifications should prohibit the use of rock or rock-soil mixtures as backfill in

areas where heavy equipment cannot operate. Rock-soil mixtures having greater than 8 to 10 percent binder should be prohibited in all areas. In the case of backfill containing rock, the density is not generally specified. Obtaining adequate density is usually achieved by specifying the compaction procedures. The specifications may require that these procedures be developed in field test sections.

b. Specifications may also require specific equipment and procedures to ensure adequate bedding for round-bottom structures such as tunnels, culverts, conduits, and tanks. Procedures normally specified for placement of bedding for these types of structures are discussed in paragraph 5-1c (2).

c. The specifications will state when backfill may be placed against permanent concrete construction with respect to the time after completion; this time period is usually from 7 to 14 days. To provide adequate protection of the structures during backfill construction, the specifications require that the backfill be built up symmetrically on all sides and that the area of operation of heavy equipment adjacent to a structure be limited. Also, the minimum thickness of compacted materials to be placed over the structures by small compaction

equipment, such as vibratory plate or rammer type, will be specified before heavy equipment is allowed to operate over the structure. The specifications require that the surface of the backfill be sloped to drain at all times when necessary to prevent ponding of water on the fill. The specifications also provide for groundwater control, so that all compacted backfill will be constructed in the dry. Where select, free-draining, cohesionless soils of high permeability are required in areas where compaction is critical, the specifications list gradation requirements. Gradation requirements are also specified for materials used for drains and filters.

d. Unusually severe specification requirements may be necessary for backfill operations in confined areas. The requirements may include strict backfill material type limitation, placement procedures, and compaction equipment.

e. It is not the policy of the Government to inform the contractor of ways to accomplish the necessary protection from freezing temperatures. However, to ensure that adequate protection is provided, it may be necessary to specify that the contractor submit detailed plans for approval for such protection.

CHAPTER 7

CONSTRUCTION CONTROL

7-1. General. The heterogeneous nature of soil makes it the most variable construction material with which engineers are required to work. Research in soil mechanics and experience gained recently in constructing large earth embankments have provided additional knowledge toward understanding and predicting the behavior of a soil as a construction material. However, only with careful control can engineers ensure that backfill construction will satisfactorily fulfill the intended functions. Both the contractor and the Government share dual responsibility in achieving a satisfactory product. The contractor is responsible for inspection and tests through his quality control system. The Government's responsibility is assuring that the contractor's quality control system is achieving the desired results through its quality acceptance system.

a. Contractor quality control. The contractor is responsible for all of the activities that are necessary to ensure that the finished work complies with the plans and specifications to include quality control requirements, supervision, inspection, and testing. The construction contract special provisions explain the quality control system that the contractor must establish; the technical provisions specify the construction requirements with the tests, inspections, and submittals that the contractor must follow to produce acceptable work.

(1) Prior to construction, the contractor must submit for approval by the Contracting Officer his plan for controlling construction quality. The plan must contain all of the elements outlined in the special provisions and demonstrate a capability for controlling all of the construction operations specified in the technical provisions. The plan must include the personnel (whether contractor's personnel or outside private firm) and procedures the contractor intends to use for controlling quality, instructions and authority he is giving his personnel, and the report form he will use. The plan should be coordinated with his project construction schedule.

(2) During construction, the contractor is responsible for exercising day by day construction quality control in consonance with his accepted control plan. He must maintain current records of his quality control operations. Reports of his operations must be submitted at specified intervals and be in sufficient detail to identify each specific test.

(3) The prime contractor is responsible for the quality control of all work including any work by subcontractors.

b. Corps acceptance control. In contrast to the contractor's quality control, the Government is responsible for quality assurance, which includes: the checks, inspections, and tests of the products that comprise the construction; the processes used in the work; and the finished work for the purpose of determining whether the contractor's quality control is effective and he is meeting the requirements of the contract. These activities are to assure that defective work or materials are not incorporated in the construction.

c. Coordination between Government and contractor. The contractor's quality control does not relieve the Contracting Officer from his responsibility for safeguarding the Government's interest. The quality assurance inspections and tests made by the Government may be carried out at the same time and adjacent to the contractor's quality control operations. Quality control and quality assurance supplement one another and assist in avoidance of construction deficiencies or in early detection of such deficiencies when they can be easily corrected without requiring later costly tear out and rebuild. The remainder of this chapter discusses the Corps quality assurance activities.

7-2. Corps acceptance control organization.

a. General. Difficulties in construction of a compacted backfill can be attributed at least in part to inexperience of the control personnel in this phase of construction work or lack of emphasis as to the importance of proper procedure and control. Since it is essential that policies with regard to control be established prior to the initiation of construction, thorough knowledge of the capabilities of the control organization and of the intent of the plans and specifications is required. Control is achieved by a review of construction plans and specifications, visual inspection of construction operations and procedures, and physical testing. A well-organized, experienced inspection force can mean the difference between a good job and a poor one. A good field inspection organization must be staffed and organized so that inspection personnel and laboratory technicians are on the job when and where they are needed. Thus the organization must have knowledge of the construction at all times.

b. Inspection personnel training program. Prior to construction, the training, guidance, and support required to ensure that the inspection force is fully competent should be determined. If experience is lacking, training and supervision become more important and necessary.

(1) The training program for earthwork inspection personnel should consist of both classroom and field instruction. During the classroom sessions, the specifications should be studied, discussed, and interpreted as to the intent of the designer. The critical areas of compaction should be pointed out as well as the location of zoned and transitional areas. The inspection personnel should be instructed on the various zones of backfill, types of backfill, density requirements, and classification and compaction characteristics for each class of backfill. Inspection personnel should also be instructed as to approved sources of borrow for each type of backfill and borrow pit operations, such as loading procedures to provide uniform materials and pre-wetting to provide uniform moisture.

The various types of backfill should be studied, so inspection personnel can recognize and readily identify these materials. Jar samples may be furnished for later reference and comparison; preferably these should be samples of the particular soils on which laboratory compaction tests were performed in design studies. Instructions should be given as to water content control, lift thickness, and most suitable compaction equipment for each type of backfill. Inspection personnel should be capable of recommending alternate procedures to achieve the desired results when the contractor's procedure is unsuccessful.

(2) Inspection personnel should be made aware of the importance of their work by explaining the engineering features of the design on which the construction requirements are based. Every opportunity should be taken to assemble the inspection force for discussion of construction problems and procedures so that all can gain knowledge from the experience of others. Inspection personnel should be kept informed of all decisions and agreements pertinent to their work that are made at higher levels of administration. They should be advised of the limits of their authority and contact with contractor personnel.

(3) Field training of inspection personnel should include observation of their control techniques and additional instruction on elements of fieldwork requiring correction. Inspection personnel should be instructed in the telltale signs that give visual indications whether sufficient compaction is being applied and proper water content is being maintained (see para 7-5b (4) and EM 1110-2-1911 for discussion of telltale signs). They should develop the ability to determine from visual observations (based on correlations with tests on the project) that satisfactory compaction is being obtained so

that considerable emphasis can be placed on such methods as a control procedure rather than relying on field tests alone. Inspection personnel should be capable of selecting locations at which field density and moisture determinations should be made. To meet this requirement they must be present almost continuously during compaction operations to observe and note areas where tests appear to be needed. Laboratory technicians should be made available to perform tests so that the inspection personnel will be free to observe the placement and compaction process on another portion of the backfill. Inspection personnel should be able to use expedient quick-check field apparatus such as the Proctor and hand-cone penetrometers (sec. B-3, app. B) to make a rapid check of the field water content to supplement acceptance testing and to serve as a guide in determining areas that should be tested. Inspection personnel should also be well versed in normal testing procedures so they can properly supervise testing or explain the procedure in case they are questioned by contractor personnel.

(4) It is necessary and important that inspection personnel ascertain their authority and responsibility at an early stage in the construction. Their policy should be one of firmness coupled with practicality. The quality of the work should not be compromised; however, unreasonable requirements and restrictions should not be placed on the contractor in enforcing the specifications. If the inspection personnel know their job and are fair and cooperative in dealing with the contractor, they will gain his or her respect and cooperation and be able to efficiently carry out their responsibilities.

b. *Field laboratory facilities.* The field laboratory is used for routine testing of construction materials (such as gradation, water content, compaction, and Atterberg limits tests) and for determining the adequacy of field compaction. The data obtained from tests performed by inspection personnel serve as a basis for determining and ensuring compliance with the specifications, for obtaining the maximum benefit from the materials being used, and for providing a complete record of the materials placed in every part of the project. The size and type of laboratory required are dependent on the magnitude of the job and the type of structures being built. Where excavation and backfill construction are extensive and widespread, the establishment of a centrally located field laboratory is generally beneficial. This laboratory in addition to having equipment for on-the-job control will provide a nucleus of experienced soils engineers or engineering technicians for general supervision and training of inspection personnel. Field control laboratories on the sites may be established as necessary during the excavation and backfill phases of the construction. They may be set up

in an enclosed space allocated by the project officer or in mobile testing laboratories, such as pickup trucks with a camper and equipped with the necessary testing equipment for performance of field density tests, water content tests, and gradation tests. Another possibility is the use of large portable boxes in which equipment is stored. When special problems arise and the required testing equipment is not available at the site laboratory, the testing should be performed at the central laboratory.

7-3. Excavation control techniques. Control to obtain a satisfactory excavation is exercised by enforcement of approved plans, visual observations, a thorough knowledge of the contractor's plan of operation and construction schedule, the dimensions and engineering features of the structure(s) to be placed in the excavation, and vertical and horizontal control measurements to ensure that the proper line and grade requirements are met.

7-4. Foundation preparation control techniques. The main control technique for ensuring proper foundation preparation is visual inspection.

Prior to backfill placement, all uncompacted fill should be removed from those portions of the excavation to be backfilled. The items included are road fills, loose material that has fallen into overexcavated areas adjacent to foundations, and construction ramps other than those required for access to the excavation. Identification of such items will be easier if the inspection personnel have charted the items on the plans as they were created, since they are not always easily discernible by visual inspection. It is desirable to control earth backfill placed in foundation leveling operations by water content and density tests. Care should be exercised to ensure that all subdrains required in the foundation are protected by filters and transitional zones that are adequate to prevent infiltration of fines from the surrounding backfill that might otherwise clog the drains and undermine structures.

7-5. Backfill quality acceptance control.

The necessary authority to assure that compacted backfill is in compliance with the specifications is given in the specifications. The control consists of inspecting and testing materials to be used, checking the amount and uniformity of soil water content, maintaining the proper thickness of the lifts being placed, and determining the dry unit weight being obtained by the compaction process. While control consists of all of these things, good inspection involves much more.

a. Inspection activities. One of the best inducements to proper placement and compaction of backfill is the presence of the inspection personnel when backfill is being placed. However, to be of value the inspector must know his job. He should be familiar with

all aspects of backfill operation, such as selection and availability of materials, processing, hauling, compaction, and inspection procedures. Some of the most common deficiencies in inspection personnel activities are as follows:

(1) Failing to enforce specification requirements for preparation of the area for backfill. Often temporary fills, the working platform, debris, and other undesirable materials are left in the excavation causing weak areas and resulting in greater consolidation in the backfill.

(2) Failing to be cognizant of detailed site-adapted plans for stockpiling and placing backfill at specific locations. Without knowledge of these plans, inspection personnel are sometimes forced to make engineering decisions beyond their capability, such as on-the-site approval of a new material or mixture of materials, and stockpile locations.

(3) Allowing processing of backfill material and adjustment of water content on the fill that should have been accomplished prior to placement. The results are the segregation of grain sizes and the non-uniform distribution of water content. All major processing, including crushing, raking, mixing, and adjusting of water content, must be done in the stockpile or borrow areas.

(4) Allowing lift thickness that is inconsistent with equipment capabilities and thicker than that allowed by specifications. Field density determinations will not necessarily detect this inconsistency.

(5) Allowing construction of backfill slopes that are too steep to obtain the full effect of compaction equipment.

(6) Failing to require that the fill be built up uniformly in a well-defined pattern. Since the contractor's next move cannot be predicted, the inspection personnel cannot adequately plan their operations, and it is difficult to determine which areas of backfill have been tested and approved when the backfill is built up in an unorganized manner.

(7) Allowing segregation of coarse-grained, non-cohesive materials. This condition is caused by improper hauling, dumping, and spreading techniques.

(8) Allowing the use of compaction equipment not suited to material being compacted.

(9) Failing to perform sufficient field density testing in critical areas.

(10) Allowing material that is too wet or too dry to be compacted.

(11) Failing to require that intermediate backfill surfaces be shaped to drain during backfilling at other locations.

b. Inspection requirements. To properly control and inspect backfill operations, the inspection personnel must keep informed of the construction schedule at all times and be at the site where backfill is being placed.

The inspection personnel must be thoroughly familiar with every aspect of the earthwork section of the specifications and know boundary locations for the various zones of material. They should be able to readily identify the various classes of backfill and know their compaction characteristics and requirements.

Good inspection personnel will also know the compaction capabilities of various types of equipment and the materials that each type is best suited to compact.

(1) To maintain adequate control of compaction operations, a staff of earthwork inspectors and laboratory personnel commensurate with the importance of the work and size of the operation is essential. There should be at least one inspector at the fill when backfill is being placed. His sole duty should be inspection of earthwork. Although he should be familiar with the testing procedures and capable of directing testing operations and selecting locations for testing, he should not be required to perform the tests. Laboratory technicians should be available for this purpose. A discussion of the methods and procedures for field density testing of the compacted fill is contained in section B-3, appendix B.

(2) The specifications should require that necessary processing of backfill materials be performed in the stockpile or borrow pit. Processing includes raking or crushing to remove oversize material, mixing to provide uniformity, and watering or aerating to attain a water content approximating optimum for compaction. An earthwork inspector is required at the stockpile or borrow pit to enforce these provisions. In addition, this inspector has the duties of classifying the materials, determining their suitability, and directing the zone of backfill in which they are to be placed. He is charged with the responsibility of seeing that the contractor uses the materials available for backfill in the most advantageous manner. Generally, the stockpile or borrow pit inspector relies upon visual inspection and experience to exercise control over these operations. Occasionally, he may require that appropriate tests be performed to confirm his judgment.

(3) The duties of the backfill inspector consist of checking the material for suitability as it is placed on the fill and spread, ensuring that any oversize material, roots, or trash found in the material is removed, checking the thickness of the lift prior to compaction, checking for uniformity and amount of water content, observing compaction operations, and directing or monitoring testing of the compacted material for compliance with density and water content requirements.

(4) There are many techniques and rule-of-thumb procedures that the earthwork inspector can and must resort to for assistance in his work. A few of them are discussed below; others can be ascertained by

inspectors meeting together to discuss problems and corrective action.

(a) The thickness of loose lifts can be checked easily by probing with a calibrated rod just prior to compaction. Compaction of lifts too thick for the equipment will not normally be detected by performing density tests on the lift, since adequate compaction may be indicated by a test made in the upper portion of the lift and the lower portion may still have too low a density. It is therefore a requisite that lift thickness be controlled on a loose-thickness basis prior to compaction.

(b) Checks for proper bond between layers can be made by digging through a lift after compaction and using a shovel to check this bond. If the soil can be separated easily along the plane between lifts, sufficient bond is not being provided. Backfill materials should not be placed on dried or smooth surfaces, as bond will be difficult to obtain.

(c) Inspection personnel should be thoroughly aware of areas where compaction is critical. These areas are the confined spaces around and adjacent to structures that are not accessible to the rolling and spreading equipment. Although the volume of backfill is usually rather small in these areas, a much higher frequency of check testing for density is required as well as a careful check of the quality and water content of the materials to be placed.

c. Compaction control tests. Compaction tests will have been performed on representative specimens obtained from exploratory sampling prior to construction. The selection of suitable backfill material are in fact generally made based on these and other tests. At least during the early phases of the backfill operation, density requirements are based on these and in some cases additional preconstruction compaction tests. Conditions may develop that require compaction tests during backfill operations to establish new density requirements. Generally, these changes are the results of backfill material deviations. The need for additional control tests may be ascertained from visual observation and changes in compaction characteristics during field compaction. For most backfill materials, quality acceptance compaction control tests must be performed according to the CE 55 test procedure specified in MIL-STD-621, the equivalent procedure in ASTM D 1557, or the two-point test procedure (app B). For some cohesionless soils where higher maximum dry densities can be obtained using the vibratory (relative density) compaction procedure, the specifications may require the vibratory test procedures as specified in EM 1110-2-1906 or ASTM D 2049. Field compaction control and rapid compaction check tests that are used to supplement the Corps acceptance control tests are discussed in appendix B.

d. Field moisture-density control techniques. Moisture-density control is the most important phase of

backfill operations. The success of ensuring required backfill density often determines the functional service of the imbedded structure. Good control involves many techniques. An experienced inspector will not rely on any one technique but from experience will base his control on a combination of techniques. Moisture-density control techniques may be grouped into three categories: rule-of-thumb techniques, and indirect and direct moisture density measurements.

(1) *Rule-of-thumb methods.* Rule-of-thumb techniques are derived from experience and are based on visual observations and feel of the material. A rule-of-thumb for judging if the water content of a fine grained, plastic material is near the optimum water content consists of rolling the material between the hands until it forms a thread approximately $\frac{1}{8}$ inch in diameter. If the material at this stage tends to crack or crumble, it is in the proper water content range for compaction. It will be recognized that this method is similar to the method of determining the plastic limit of a soil. The methods are similar because the optimum water content for compaction of a cohesive soil roughly approximates the plastic limit of the soil.

(a) Another good indication of whether the proper water content has been obtained can be determined by observing the compacting equipment. When a sheepsfoot roller is being used and the soil sticks to the roller to any great extent, the material is being rolled too wet for the equipment being used; at optimum water content it may be expected that a few clods will be picked up by the roller but a general sticking will not occur. If the compacted fill does not definitely spring (noticeable to visual observation) under hauling and compaction equipment, it is probable that several lifts of fill have been placed too dry. The roller should roll evenly over the surface of the backfill if water content is uniform throughout the lift and should not ride higher on some portions of the backfill than on others. If on the first pass of a rubber-tired roller the tires sink to a depth equal to or greater than one half the tire width, if after several passes the soil is rutting excessively, or if at any time during rolling the weaving or undulating (as opposed to normal "springing" of the surface) of the material is taking place ahead of the roller, either the tire pressure is too high or the water content of the material is too high. On the other hand, if the roller tracks only very slightly or not at all and leaves the surface hard and stiff after several passes, the soil is probably too dry. For most soils having proper water contents, the roller will track evenly on the first pass and the wheels will embed 3 to 4 inches. Some penetration should be made into soil at its proper water content, though the penetration will decrease as the number of passes increases. After several passes of a sheepsfoot roller, the roller should start walking out if adequate and efficient compaction is being obtained. Walking out means the roller begins bearing on the soil through its feet only-the drum is riding

a few inches above the soil surface. If the roller walks out after only a few passes, the soil is probably too dry; if it does not walk out but continues churning up the material after the desired number of passes, the soil is too wet or the foot contact pressure is too high.

(b) A trained inspector will spend some time in the field laboratory, performing several compaction tests on each type of backfill material to become familiar with the differences in looks, feel, and behavior and learning to recognize when they are too dry or too wet, as well as when they are at optimum water content.

(2) *Indirect methods.* Indirect methods of determining the density and water content involve measurement of the characteristic of the material that has been previously correlated to the maximum density and optimum water content. These methods of measuring in-place density and water content can usually effect a more detailed control of a job than can be accomplished by direct methods alone because they can provide quicker determinations. However, no indirect method should ever be used without first checking and calibrating it with results obtained from direct methods, and periodic checks by direct methods should be made during construction. Indirect methods include the use of the nuclear moisture-density meter, the Proctor penetrometer (often referred to as the "Proctor needle"), the hand cone penetrometer, and in the hands of an experienced inspector even a shovel.

(a) The nuclear moisture-density method conducted in accordance with ASTM D 2922 (for density determination) and ASTM D 3017 (for water content determination) is the only indirect control method used for the Corps quality acceptance control. The method provides a relatively rapid means for determining both moisture content and density. Of the three methods presented in ASTM D 2922, Method B - Direct Transmission is the best suited for a compacted lift thickness exceeding approximately 4 inches. The nuclear moisture-density method is discussed in more detail in section B-3, appendix B.

(b) Penetrometers, such as the Proctor and hand cone penetrometers, are useful under certain conditions for approximating density. However, both methods require careful calibration using soils of known density and water content and considerable operating experience. Even then, the results may be questionable because non-uniform water content (in fine-grained material) or a small piece of gravel can affect the penetration resistance. Penetrometers, therefore, are not recommended for general use in compaction control; however, they can be a very useful tool in supplementing the inspector's visual observations and providing a general guide for detecting areas of doubtful compac

tion. The procedure using the Proctor penetrometer for determining the relation between wet density, penetration resistance, and water content is described in ASTM D 1558 and in section B-3, appendix B. The hand cone penetrometer procedure also is discussed in section B-3.

(c) Many inspectors in the past have had good success in estimating density by simply observing the resistance of the compacted soil to penetration by a spade. This method requires considerable experience and is useful only in detecting areas that might require further density tests.

(3) Direct methods. Direct field density determination consists of volume and weight measurements to determine the wet density of in-place backfill and water content measurements to determine in-place water contents and dry densities. The three methods used for the Corps quality acceptance density determination are: (a) the sand-cone method according to MIL-STD-621 (Method 106) and ASTM D 1556; (b) the rubber-balloon method according to ASTM D 2167; and for soft, fine-grained cohesive soils, the drive-cylinder method according to MIL-STD-621 (Method 102) and ASTM D 2937. In addition to the approved methods, a method sometimes employed to measure densities of coarse-grained cohesionless material consists of the large-scale, water-displacement method. The large-scale, water-displacement method is discussed in EM 1110-2-1911. The sand cone method is considered to be the most reliable method and is recommended as the proof or calibration test for calibrating other methods such as the nuclear density method. The direct field density methods are discussed in section B-3, appendix B.

e. Water content by microwave oven. The biggest problem associated with both field compaction tests and in-place density and water content control tests is the length of time required to determine water content. Conventional overdrying methods require from 15 to 16 hours for most fine-grained cohesive soils. In some cases, such as confined zones, the contractor may have placed and compacted several layers of backfill over the layer for which density tests were made before quality acceptance test data are available. Even though the contractor places successive layers at his own risk, a rapid turn around between testing and test results could prevent costly-tear out and recompact procedures. Drying specimens in microwave ovens offers a practical means for rapid determination of water content for most backfill materials if properly conducted. Times required for drying in a microwave oven are primarily governed by the mass of water present in the specimen and the power-load output of the oven. Therefore, drying time must be calibrated with respect to water content and oven output. Also, it may not be possible to successfully dry certain soils containing gypsum or highly metallic soils such as iron ore, aluminum rich soils, and bauxite.

Details of the microwave-oven method used for rapid determination of soil water content is given in section B-3, appendix B.

f. Frequency and location of quality acceptance density tests. Acceptance control testing should be more frequent at the start of backfill placement. After compaction effort requirements have been firmly established and inspection personnel have become familiar with materials behavior and acceptable compaction procedures, the amount of testing can be reduced. Many factors influence the frequency and location of tests. The frequency will be dependent on the type of material, adequacy of the compaction procedures, and how critical the backfill being compacted is in relation to the performance of the structure.

(1) A systematic testing program should be established at the beginning of the job. Acceptance control tests laid out in a predetermined manner are usually designated as routine control tests and are performed either at designated locations or at random representative locations, no matter how smoothly the compaction operations are being carried out. A routine acceptance control test should be conducted for at least every 200 cubic yards of compacted backfill material in critical areas where settlement of backfill may lead to structural distress and for at least every 500 cubic yards in open areas not adjacent to structures.

(2) In addition to routine acceptance control tests, tests should be made in the following areas: where the inspector has reason to doubt the adequacy of the compaction; where the contractor is concentrating fill operations over relatively small areas; where small compaction equipment is being used such as in confined areas; and where field instrumentation is installed, mainly around riser pipes.

g. Errors in field density measurements. Density and water content measurements determined by any of the methods discussed above are subject to three possible sources of errors. The three categories of possible error sources are human errors, errors associated with equipment and method, and errors attributed to material property behavior.

(1) Human error includes such factors as improper equipment readings and following improper test procedures. Human errors are not quantitative. However, errors of this type may be minimized by utilizing competent testing personnel familiar with testing procedures.

(2) There are two types of possible errors related to test equipment. One type of error relates to the sensitivity of the equipment with respect to its capability to accurately measure the true density or water content. Sensitivity errors are quantitative only in the sense that limiting ranges of possible error can be es

tablished. An example of sensitivity error would be the nuclear density device that is capable of determining densities only to within 3 to 5 pounds per cubic foot of the true density. The second type of error relates to constant deviations between measured and true density. Constant deviation errors can be corrected by calibrating test equipment against known densities.

(3) Material property errors are primarily limited to density determinations using either the sand-cone or the rubber-balloon method in sands. When a soil is physically sampled during the process of conducting an in-place density measurement using these two methods, a shearing action of the soil is unavoidable. Cohesionless soils are sensitive to volume change during shear, dense sands tend to expand and increase in volume, and loose sands tend to contract and decrease in volume. Errors of this nature cannot be quantified or detected in the field. However, such errors can be as high as 6 percent for sand using the rubber-balloon method for volume measurements.

h. Acceptance or rejection. The inspection personnel have the responsibility to accept or reject the backfill or any part thereof based on the quality acceptance control tests. On the surface, this task seems straightforward. If a segment of the backfill tested at several locations for acceptance passes or fails to pass minimum requirements by a wide margin, then it is generally safe to assume that the backfill within that segment either has or has not been adequately compacted and the acceptance or rejection of that segment can be made based on the test results. On the other hand, if the tests indicated insufficient compaction, the size of the affected area may be questionable; it is possible that the test(s) represents only a small area and the lift being tested may be sufficiently compacted elsewhere. In view of the possible errors associated with control tests, tests that indicate marginal passage or failure should be treated with caution. The borderline case requires a close look at several factors: how the result compares with all previous results on the job, how much compaction effort was used and did it differ from previous efforts, how does this particular material compare with previously compacted materials, the importance of the lift location in relation to the entire structure, and the importance of obtaining the correct density or water content from the designer's standpoint. When all factors have been considered, a decision is made as to which corrective measures are required. What makes such decisions so difficult is that they must be made immediately; time will not permit the problem to be pondered. Discussion with design engineers prior to beginning compaction operations may help in the evaluation of many of these factors.

(1) On jobs requiring large volumes of backfill, it may be advantageous to base the decision to accept or reject on statistical methods. Statistical

methods require separate analysis for each backfill material type and compaction effort, complete random selection of test locations, and a large number of control tests as compared with the conventional decision method. In addition, statistical methods include water content control, which is not normally included in military specifications.

(2) The theory and details concerning the application of statistical methods for compaction control are well developed. Figure 7-1 shows a sequential inspection plan example of how the end results of a statistical analysis might be used for the purpose of acceptance or rejection. In this example, it was established by statistical analysis that adequate densities could probably be obtained with reasonable confidence by a given compaction effort for desired water contents ranging from 3 percentage points below to 1 percentage point above optimum. It was also established that a density corresponding to 95 percent of CE 55 maximum dry density was the minimum acceptable density based on required engineering performance of the backfill. The sequential inspection plan consists of examining, in sequence, single tests that are obtained at random from a segment of the backfill being considered for acceptance or rejection and, for each test, making one of three possible decisions: the segment is acceptable; the segment is unacceptable; and the evidence is not sufficient for either decision without too great a risk of error as indicated by the retest block in figure 7-1(a). The reject areas in figure 7-1 indicate conditions that cannot be corrected by additional rolling. The material must be replaced in thinner lifts and be within the desired water content range before adequate compaction can be achieved with the compaction equipment being used. If the retest decision is reached, an additional test is made at a second random location, and the same three decisions are reconsidered in light of this additional information. If the second test falls below the accept blocks, the segment of backfill representative of that test should be rejected; or if compaction procedures that have produced acceptable tests in the past have not been altered, then the compaction characteristics of that part of the backfill should be reevaluated.

(3) The primary advantage of statistical methods is that they offer a means of systematically evaluating acceptance or rejection decisions rather than leaving such decisions entirely to the judgment of the inspection personnel. However, if experienced and well trained inspection personnel are available, this approach may not be necessary.

i. Construction reports. A record should be maintained of construction operations. It is valuable in the event repairs or modifications of the structure are required at a later time. A record is necessary in the event claims are made either by the contractor or the

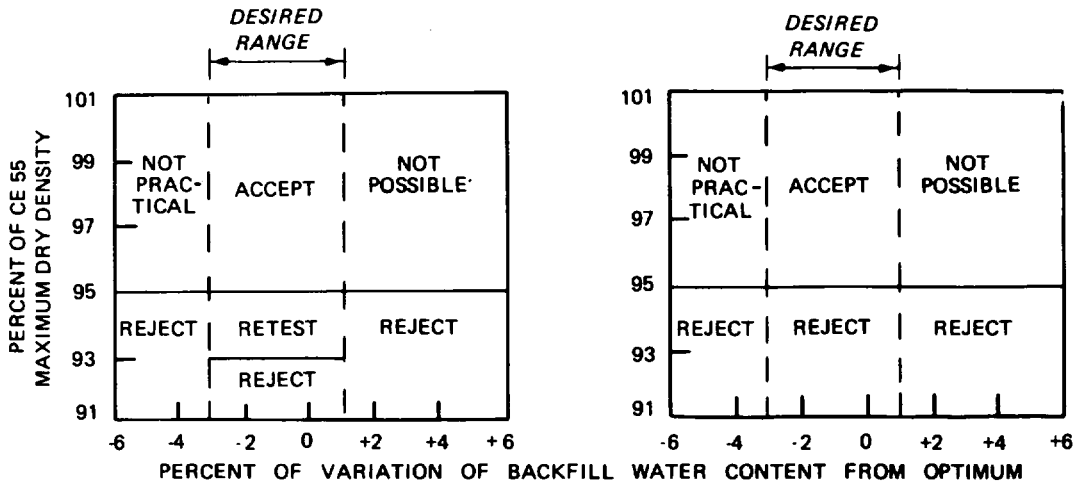

a. USE FOR INITIAL TEST OF BACKFILL AT RANDOM LOCATION

b. USE FOR RETEST OF BACKFILL AT RANDOM LOCATION

NOTE: 95=SPECIFIED MINIMUM ACCEPTABLE PERCENT OF CE 55 MAXIMUM DRY DENSITY

Figure 7-1. Acceptance Rejection Scheme for a Backfill Area.

Contracting Officer that work required or performed was not in accordance with the contract. Recorded data are also beneficial in improving knowledge and practices for future work. The basic documents of the construction record are the plans and specifications, modifications adopted that were considered to come within the terms of the contract, amendments to the contract such as extra work orders or orders for change, results of tests, and measurements of work performed. The amount of reporting required varies according to the importance and magnitude of the earthwork construction phase of the project and the degree of available engineering supervision. The forms to be used should be carefully planned in advance, and the inspection personnel should

be apprised of the importance of their reports and the need for thorough reporting. Records should be made on every test performed in the laboratory and in the field. All information necessary to clearly define the locations at which field tests are made should be presented. In the daily reports, inspection personnel should include information concerning progress, adequacy of the work performed, and retesting of areas requiring additional work to meet specifications. These daily reports could be of vital importance in subsequent actions. It is good practice for the inspection personnel to keep a daily diary in which are recorded the work area, work accomplished, test results, weather conditions, pertinent conversations with the contractor, and instructions received and given.

APPENDIX A

REFERENCES

Government Publications

Department of Defense

Military Standards MIL-STD-619	Unified Soil Classification System for Roads, Airfields, Embankments, and Foundations.
MIL-STD-621	Test Methods for Pavement Subgrade, Subbase, and Base Course Materials

Department of the Army, the Navy, and the Air Force

Technical Manuals

AFM 89-3, Chapter 2 TM 5-818-1/AFM 88-3, Chap. 7	Materials Testing Soils and Geology: Procedures for Foundation Design of Buildings and Other Structures (Except Hydraulic Structures)
TM 5-818-2/AFM 88-6, Chap. 4 TM 5-818-5/NAVFAC P-418/ AFM 88-5, Chap. 6	Pavement Design for Frost Condition Dewatering and Groundwater Control for Deep Excavations
TM 5-818-6 TM 5-820-2/AFM 88-5, Chap. 2 TM 5-820-4/AFM 88-5, Chap. 4 NAVFAC DM-7	Grouting Methods and Equipment Subsurface Drainage Facilities for Airfields Drainage for Areas Other Than Airfields Soil Mechanics, Foundations, and Earth Structures

Department of the Army, Corps of Engineers

USACE Publications Depot, 809
South Pickett, Alexandria, VA
22304

EM 385-1-1 EM 1110-2-1906 Em 1110-2-1908 EM 1110-2-1911 EM 1110-2-2502 EM 1110-2-2902 ER 1110-2-1806	Safety and Health Requirements Manual Laboratory Soils Testing Instrumentation for Earth and Rockfill Dams Construction Control for Earth and Rockfill Dams Retaining Walls Conduits, Culverts, and Pipes Earthquake Design and Analysis for Corps of Engineers Dams
--	--

Department of Interior

Bureau of Reclamation, Manual, Second Edition	Earth Manual
--	--------------

Department of Transportation (DOT) 1920 L Street, N.W., Washington, DC 20036

Report No. FHWA-RD-78-141	Design and Construction of Compacted Shale Embankments, Vol 5. Technical Guidelines (December 1978)
---------------------------	--

Report No. FHWA-RD-79-51

Technical Guidelines for Expansive Soils in Highway Subgrades (June 1979)

Non-Government Publications

American Society for Testing and Materials; 1916 Race Street, Philadelphia, PA 19103

D 1556	Standard Test Method for Density of Soil in Place by the Sand-Cone Method
D 1557	Standard Test Methods for Moisture-Density Relations of Soils Using 10-lb. (4.5 kg) Rammer and 18-in. (457-mm) Drop
D 1558	Standard Test Method for Moisture-Penetration Resistance Relations of Fine-Grained Soils
D 2049	Standard Test Method for Relative Density of Cohesionless Soils
D 2167	Standard Test Method for Density of Soil In Place by the Rubber-Balloon Method
D 2216	Standard Method of Laboratory Determination of Moisture Content
D 2922	Standard Test Method for Density of Soil and Soil-Aggregate In Place by the Nuclear Methods
D 2937	Standard Test Method for Density of Soil In Place by the Drive-Cylinder Method
D 3017	Standard Test Method for Moisture Content of Soil and Soil-Aggregate In Place by the Nuclear Methods
Special Technical Publication	Symposium on Nuclear Methods for Measuring Soil Density and Moisture STP No. 293 (June 1960)
Special Technical Publication	Special Procedures for Testing Soil and Rock for Engineering Purposes STP No. 479 (June 1970)
Special Technical Publication	Soil Specimen Preparation for Laboratory Testing (June 1976) STP No. 599

APPENDIX B

**FUNDAMENTALS OF COMPACTION, FIELD COMPACTION TEST METHODS,
AND FIELD MOISTURE-DENSITY TEST METHODS**

SECTION B-1. FUNDAMENTALS OF COMPACTION

B-1. Factors Influencing compaction. Soil compaction is the act of increasing the density (unit weight) of the soil by manipulation by pressing, ramming, or vibrating the soil particles into a closer state of contact. The most important factors in soil compaction are type of soil, water content, compaction effort, and lift thickness. It is the purpose of field inspection to ensure that the proper water content, lift thickness, and compaction effort are used for each soil type so that the desired degree of compaction is obtained. When the water content, lift thickness, or compaction effort being used does not produce the desired degree of compaction, changes may be necessary. The determination of the necessary changes of these factors to produce the desired degree of compaction requires knowledge of the principles governing the compaction of soils. Therefore, it is important that inspection personnel have a general understanding of the fundamentals of compaction.

a. General. It has been established through research and construction experience that there is a maximum density to which a given soil can be compacted using a particular compaction effort. For each soil and a given compaction effort, there is a unique water content, which is called the optimum water content, that produces the maximum density. The purpose of the laboratory compaction test is to determine the variation in density of a given soil at different water contents when compacted at a particular effort or efforts. Normally, the soil to be used is compacted in the laboratory over a range of water contents using the impact compaction procedures given in MIL-STD-621A and ASTM D 1557. The compaction effort used is selected on the basis of the requirements of the structure. In foundation or backfill design for most major structures, the CE 55 (also termed modified) compaction effort that produces approximately 56,000 foot-pounds per cubic foot of compacted soil should be used.

(1) For some cohesionless soils, a greater maximum density can be obtained using vibratory-type compaction procedures given in EM 1110-2-1906 and ASTM D 2049 than can be obtained using MIL-STD-621A or ASTM D 1557 impact-compaction procedure. Thus, there may be cases where the vibratory compaction method may be more appropriate in

determining the maximum density. The compaction effort used for design purposes should be the basis for construction control.

(2) A compaction curve is developed in the impact-compaction test by plotting densities (dry unit weights) as ordinates and the corresponding water contents (as percent of dry soil weight) as abscissas. For most soils the curve produced is generally parabolic in form. Figure B-1 shows a compaction curve.

The water content corresponding to the peak of the curve is the optimum water content. The dry unit weight of the soil at the optimum water content is the maximum dry density. The zero air voids curve represents the relation between water content and dry density for 100 percent saturation of the particular material tested. Thus, it shows the dry density for a given water content based on the condition that all the air is forced out of the voids by the compaction process.

b. Influence of soil type. Compaction characteristics vary considerably with the type of soil. Figure B-2 shows four compaction curves representing the water content-density relation for four general soil types for standard compaction. The maximum dry density for a uniform sand occurs at about zero water content, although density approaching maximum can be obtained when the sand is saturated. A very sharp peaked curve of dry density versus water content is usually obtained for a silt, and water content is critical to achieving maximum density. A small change in water content (as small as 0.5 percentage point) above or below optimum causes a significant decrease in the density (as much as 2 to 4 pounds per cubic foot) for a given compaction effort. The compaction curve for a lean clay is not as sharp as that for the silt, and water content control is not as critical. Optimum water contents for silts and lean clays generally range between 15 and 20 percent. The compaction curve for fat clays is rather flat and water content is not particularly critical to obtaining maximum density; a 2 to 3 percentage point change in water content from optimum for fat clays causes only a small decrease (1 pound per cubic foot or less) in density. The maximum dry density, as obtained in laboratory compaction tests using MIL-STD-621A and

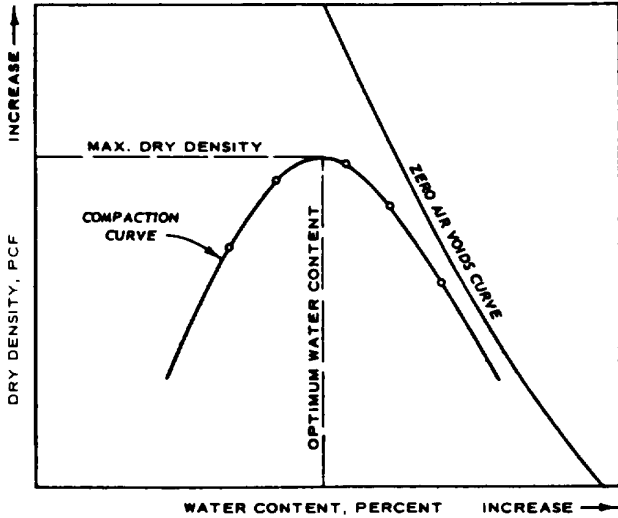

Figure B-1. Compaction curve.

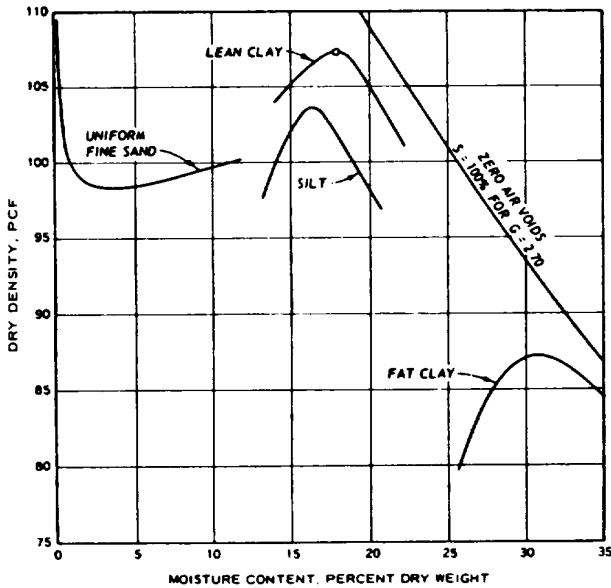

Figure B-2. Typical compaction test curves.

ASTM D 1557 or modified compaction effort, depends on the soil type and varies generally from about 125 to 140 pounds per cubic foot for well-graded, sand-gravel mixtures to about 90 to 115 pounds per cubic foot for fat clays. The optimum water content generally ranges from zero for the sand-gravel mixtures to about 30 percent for the fat clays.

c. *Influence of water content.* For a given fine-grained soil and a given compaction effort, the water content determines the state at which maximum dry density occurs. At low water contents when the soil is

stiff and hard to compress, low, dry densities and high values of air content result. As the water content is increased, higher dry densities and lower air content values are obtained. Increased densities result with an increase in water content up to optimum water content. Beyond this point, the water in the voids becomes excessive, and pore pressures develop under the application of the compaction effort to resist a closer packing; lower dry densities are the result.

d. *Influence of compaction effort.* For most soils, increasing the energy applied (compaction effort) per unit volume of soil results in an increase in the maximum density (unit weight). This greater density occurs generally at a lower water content. This phenomenon is evident in both field and laboratory compactations. Thus, for each compaction effort, there is a unique optimum water content and maximum dry density for a given soil. Figure B-3 shows the effect of variation in compaction effort on the maximum dry density and optimum water content for a lean clay (CL). Where values of maximum dry density and optimum water content are specified, they should be referenced to the compaction effort used.

e. *Influence of lift thickness.* Compaction effort applied to a soil surface dissipates with depth. Therefore, it is important that the lift thickness to be compacted be commensurate with the type of soil and the compaction effort. With proper consideration and control over factors influencing compaction, most soils can be compacted to provide a stable backfill, with the

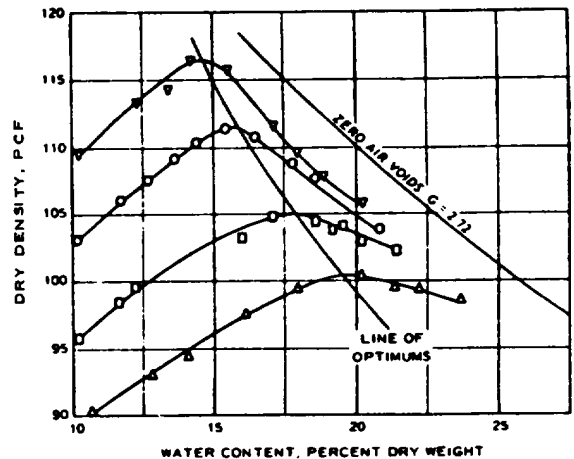

LEGEND

- ▼ 55 BLOWS PER LAYER - 56,160 FT.-LB. PER CU. FT.†
- 26 BLOWS PER LAYER - 26,440 FT.-LB. PER CU. FT.†
- 12 BLOWS PER LAYER - 12,100 FT.-LB. PER CU. FT.†
- ▲ 6 BLOWS PER LAYER - 6,050 FT.-LB. PER CU. FT.†

NOTE 10-LB. HAMMER, 18-IN. DROP
 † EQUIVALENT TO MODIFIED AASHTO EFFORT
 ‡ EQUIVALENT TO STANDARD AASHTO EFFORT

Figure B-3. Molding water content versus density-lean clay (laboratory impact compaction).

exception of certain bouldery soils and soils containing significant amounts of soluble, soft, or organic materials.

B-2. Mechanics of compaction. The influence of the water content on compaction is markedly different on coarse-grained, cohesionless soils and fine-grained, cohesive soils. As a result, the mechanics or manipulation of soil grains in the two types of soil during the compaction process are different. The mechanics of compaction for the two soil types are discussed in subsequent paragraphs.

a. Compaction of coarse-grained soils. Compaction of coarse-grained soils that contain little or no fines and thus exhibit no plasticity (termed cohesionless soils) is achieved by causing the individual particles to move into a closer, more compact arrangement, with smaller particles filling in voids between larger particles. The compaction energy overcomes friction at contact points between particles as they move past one another into closer packing.

(1) A loose volume of coarse-grained soil, such as gravel or sand, contains spaces or "voids" between individual particles that are filled with air and/or water. The density that can be obtained in such a soil under a given amount of compaction effort depends on the gradation and shapes of the particles and on the water content. For a well-graded gravel or sand, the range of particle sizes is sufficient to allow a fairly compact arrangement of particles, with smaller particles filling in the voids between larger particles. For poorly graded soil, either of uniform gradation or skip-graded (lacking a specific range of particle sizes), the distribution of particle sizes limits the density that can be obtained. Segregation of similar size particles in a skip-graded material tends to occur and prevents the voids from being greatly reduced. In a uniform soil, point-to-point contact occurs at very low compaction effort and low density results; further increase in density can only be accomplished by crushing the grains. Therefore, a well-graded, coarse-grained material can generally be compacted to a greater density under a given compaction effort than a poorly graded, coarse-grained soil. The increase in maximum density with increase in compaction effort will be greater for a well-graded soil than that for a poorly graded soil.

(2) Rounded particle shapes facilitate movement and sliding of particles, while angular particle shapes restrict movement and sliding of grains in relation to one another. For either a well-graded, or a poorly graded, coarse-grained material, increase in angularity of grains requires a corresponding increase in compaction effort to obtain a given density. However, a higher density can usually be attained with angular soils because the particle shapes are more conducive to filling the voids.

(3) For coarse-grained soils containing only a small percentage (5 or less) of fine-grained particles, maximum density is more readily obtained when the soil is either dry or saturated. For water contents between these limits, the water in the soil forms menisci between the particle contacts, which tend to hold the soil particles together. This resistance to movement of particles into a more compact structure, termed apparent cohesion or "bulking," results in lower densities than those for either a dry or saturated cohesionless soil under the same compaction effort.

(4) It is to be noted that in the preceding paragraphs, the discussion has centered around the density in weight per unit volume of coarse-grained soils with different gradation characteristics. A more realistic parameter that is often used is the relative density of cohesionless coarse-grained soils. Relative density expresses the degree of compactness of a cohesionless soil with respect to the loosest and the densest conditions of the soil that can be attained by specified laboratory procedures. A soil in the loosest state would have a relative density of zero percent and in the densest state, a relative density of 100 percent. The dry unit weight of a cohesionless soil does not, by itself, reveal how loose or how dense the soil is due to the influence of particle shape and gradation on the density. Only when viewed against the possible range of variation, in terms of relative density, can the dry unit weight be related to the compaction effort used to place the soil in a backfill or indicate the volume change tendency of the soil when subjected to foundation loads.

(5) Most coarse-grained soils can be compacted to a density such that detrimental additional consolidation will not take place under the prototype loading. This factor is the first important consideration. Another important consideration may be that the compacted soil be sufficiently pervious to provide good drainage. Proper consideration of these two basic factors will allow the use of most coarse-grained soils for backfill purposes.

b. Compaction of fine-grained soils. The mechanics by which fine-grained soils are compacted is quite complex because capillary pressures, hysteresis, pore air pressure, pore water pressure, permeability, surface phenomena, osmotic pressures, and the concepts of effective stress, shear strength, and compressibility are involved. Numerous theories have been developed in an attempt to explain the compaction mechanics. The current state-of-the-art theories involving effective stress give satisfactory explanations. The basic concepts of these theories are discussed below.

(1) Fine-grained soils are compacted in a partially saturated state; therefore, voids or pores contain both pore air and pore water between the soil particles.

Initial compaction water contents below optimum result in initial high pore air pressures and pore water pressures, which reduce shear strength and allow soil particles to slide over one another displacing the pore air to form a more dense mass. This process continues as long as the trapped pore air pressure can escape but requires increasing amounts of compaction effort to achieve higher densities since the soil particles carry increasing amounts of the compaction energy. For a given compaction effort, enough water may eventually be added to the soil so that air channels become discontinuous, and the air is trapped. When the air voids become completely discontinuous, the air permeability of the soil drops to zero; no further densification is possible because at this condition transient pore air pressures can develop that resist the compaction effort. At zero permeability the soil has reached its so-called "optimum water content." Since zero permeability may also be

established by closer packing of soil particles, it is evident that lower optimum water contents are possible at higher compaction efforts.

(2) The addition of water above optimum water content causes the voids to become completely filled with trapped pore air and pore water and thereby prevents the soil particles from moving into a more compact arrangement no matter what the compaction effort. Pore water pressure increases significantly with increasing water contents and causes increased reduction in shear strength. This fact is evident in the laboratory compaction mold when the compaction foot sinks deeper and deeper into the soil as water content increases past optimum. The same process occurs in the field when sheepsfoot rollers sink into the soil until the weight is carried by the drum or excessive rutting with rubber-tired rollers

Section B-2. FIELD COMPACTION TEST METHODS

B-3. General. Laboratory test data obtained from laboratory-compacted specimens provide a basis for design, and it is assumed that the engineering characteristics that will be built into the field-compacted backfill will be approximately the same as those of the specimens. Experience has indicated that for most soils, laboratory densities, water contents, and strength characteristics can be satisfactorily reproduced in a field-compacted backfill.

B-4. Field compaction tests.

a. Compaction control tests. Compaction control of soils requires comparison of fill water content and dry density values obtained in field density tests with optimum water content and maximum dry density, or determination of relative density if more appropriate for the fill materials that are cohesionless. For fine-grained or coarse-grained soils with appreciable fines, field results are compared with results of CE 55 laboratory (modified effort) compaction tests performed according to procedures presented in MIL-STD-621A and ASTM D 1557. For free-draining cohesionless soils, relative density of the fill material is determined, if appropriate, using vibratory test procedures prescribed in EM 1110-2-1906 and ASTM D 2049.

b. Frequency compaction control tests. The performance of a standard laboratory compaction test on material from each field density test would give the most accurate relation of the in-place material to optimum water content and maximum density, but this test is not generally feasible to do because testing could not keep pace with the rate of fill placement. However, standard compaction tests should be performed during construction (1) when an insufficient number of the compaction curves were developed during the design phase, (2) when borrow material is obtained from a new

source, and (3) when material similar to that being placed has not been tested previously. In any event, laboratory compaction tests should be performed periodically on each type of fill material (preferably 1 test for every 10 field density tests) to check the optimum water content and maximum dry density values being used for correlation with field density test results.

c. Quick field compaction tests. In addition to the standard compaction or relative density tests (para B-2a), at least four relatively quick compaction test methods can provide good approximations of maximum dry density comparable to the standard methods.

The quick compaction methods include: one-point and two-point compaction methods; the Water and Power Resource Service (WPRS), formerly U.S. Bureau of Reclamation (USBR) rapid compaction control method; and for granular cohesionless material, compaction control by gradation. Since only the one-point and two-point methods are currently accepted by the Corps of Engineers for compaction control tests, only these two methods will be discussed in detail. The USBR and gradation methods are briefly summarized.

(1) One-point compaction method. In the one-point compaction method, material from the field density test is allowed to dry with thorough mixing to obtain a uniform water content on the dry side of estimated optimum, and then compacted using the same equipment and procedure used in the five-point standard compaction test. The water content and dry density of the compacted sample are then used to estimate its optimum water content and maximum dry density as illustrated in figure B-4. The line of optimums is

well defined in the figure, and the compaction curves are approximately parallel to each other, consequently, the one-point compaction method could be used with a relatively high degree of confidence. In figure B-5, however, the optimum points do not define a line, but a broad band. Also, the compaction curves are not parallel to each other and in several instances cross on the dry side. To illustrate the error that could result from using the one-point method, consider the field density and water content shown by point B in figure B-5. Point B is close to three compaction curves. Consequently, the correct curve cannot be determined from the one point. The estimated maximum dry density and optimum water content could vary from about 92.8 pounds per cubic foot and 26 percent, respectively, to 95.0 pounds per cubic foot and 24 percent, respectively, depending on which curve was used. Therefore, the one-point method should be used only when the basic compaction curves define a relatively good line of optimum points.

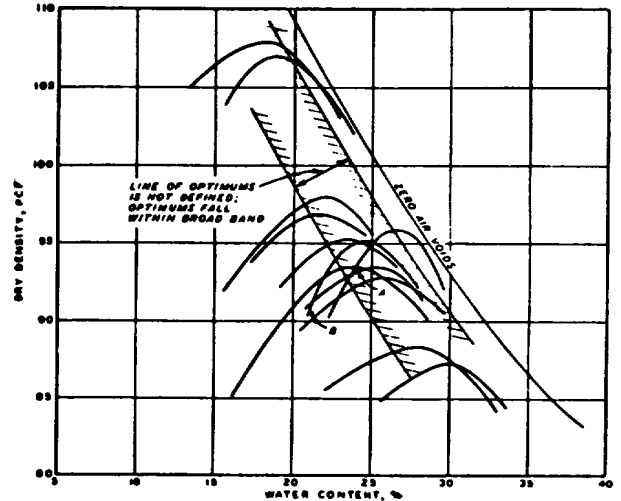
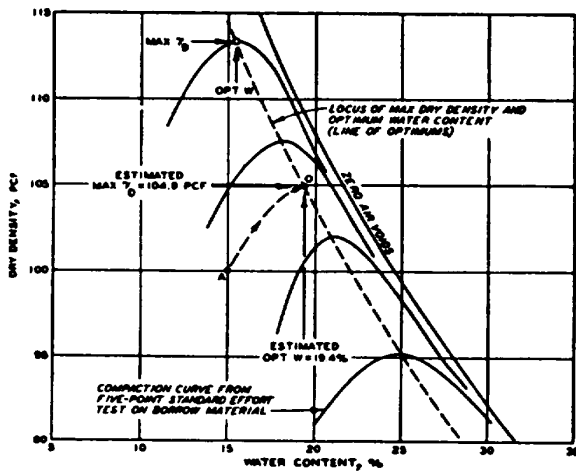

Figure B-5. Illustration of possible error using one- and two-point compaction methods.



- PROCEDURE:
1. POINT A IS THE RESULT OF A ONE-POINT STANDARD EFFORT COMPACTION TEST ON MATERIAL FROM FIELD DENSITY TEST. THIS POINT MUST BE ON THE DRY SIDE OF OPTIMUM WATER CONTENT.
 2. POINT D GIVES THE ESTIMATED OPT W AND MAX γ_d OF THE FILL MATERIAL BASED ON A PROJECTION OF POINT A APPROXIMATELY PARALLEL TO THE ADJACENT COMPACTION CURVES.

Figure B-4. Illustration of one-point compaction method.

(2) Two-point compaction test results. In the two-point test, one sample of material from the location of the field density test is compacted at the fill water content if thought to be at or on the dry side of optimum water content (otherwise, reduced by drying to this condition) using the same equipment and procedures used in the five-point compaction test. A second sample of material is allowed to dry back about 2 to 3 percentage points dry of the water content of the first sample, and then compacted in the same manner. After compaction, water contents of the two samples are determined by oven-drying or other more rapid means

(para B-8a), and dry densities are computed. The results are used to identify the appropriate compaction curve for the material test (fig. B-6). The data shown in figure B-6 warrant the use of the two-point compaction test since the five-point compaction curves are not parallel. Using point A only as in the one-point test method would result in appreciable error as the shape of the curve would not be defined. The estimated compaction curve can be more accurately defined by two compaction points as shown. Although the two-point method is more accurate than the one-point method, neither method would have acceptable accuracy when applied to the set of compaction curves shown in figure B-5.

(3) *Rapid one-point test for sands.* A rapid check test for compaction of uniform sands (SP to SM) with less than 10 percent fines (minus No. 200 sieve) is a modified one-point test. The overdry sand is compacted in a 4-inch-diameter mold using CE 55 (modified) effort. Correlation with standard compaction tests is required to confirm the validity of test results for different sands used on each project.

(4) *USBR rapid compaction control method.* Details of this method are described in the USBR Earth Manual (app A). The test is applicable to fine-grained (100 percent minus No. 4 sieve) cohesive soils with liquid limits less than 50. The method, however, is applicable to soils containing oversize particles providing the proper corrections, as stated in EM 1110-2-1911, Appendix B, are applied. It is a faster method than the standard compaction test and is often more accurate than other methods. The method usually requires adding water to or drying back sampled fill material, and thorough mixing is needed to obtain uniform drying or

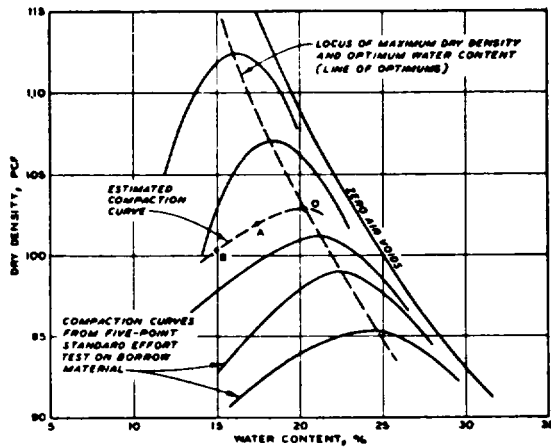

PROCEDURE:

1. POINTS A AND B ARE RESULTS OF A TWO-POINT STANDARD EFFORT COMPACTION TEST ON MATERIAL FROM FIELD DENSITY TEST. POINTS A AND B MUST BE ON THE DRY SIDE OF OPTIMUM WATER CONTENT.
2. THE ESTIMATED COMPACTION CURVE BASED ON POINTS A AND B ESTABLISHES POINT Q ON THE LOCUS, WHICH IS THE ESTIMATED MAXIMUM DRY DENSITY AND OPTIMUM WATER CONTENT OF THE FILL MATERIAL.

Figure B-6. Illustration of two-point compaction method.

distribution of added water. Otherwise, the results may be erroneous, especially for highly plastic clays. In tough clays, it is likely to be inaccurate because of insufficient curing time for the specimens.

(5) *Grain-size gradation compaction control method.* This test method developed in 1938 is applicable to coarse, medium, and fine-grained sands. The method involves sieve analysis to establish grain-size gradation curves, whose shapes are then correlated with maximum dry density obtained from the standard five-point compaction tests or relative density tests. For a given compaction effort, the maximum dry density of cohesionless material (sand) is also a function of particle shape. Thus, the correlation between grain-size distribution and density would, by necessity, have to include consideration of particle shape. It is doubtful that this method would provide test results more rapidly than the one-point and two-point methods or the relative density method currently accepted by the Corps since samples must be dried for sieve analysis. Therefore, this method is not recommended for routine compaction control.

d. *Possible errors.* All tests involving mechanical devices and human judgment are subject to errors that could affect the results. In order to properly evaluate test results, the inspector must be familiar with the possible sources of such errors.

(1) *Five-point compaction tests.* The following errors can cause inaccurate results: (a) Aggregations of air-dried soil not completely reduced to finer particles during processing.

(b) Water not thoroughly absorbed into dried material because of insufficient mixing and curing time.

(c) Material reused after compaction.

(d) Insufficient number of tests to define compaction curve accurately.

(e) Improper foundation for mold during compaction.

(f) Incorrect volume or weight of compaction mold.

(g) Incorrect rammer weight and height of fall.

(h) Excessive material extending into the extension collar at the end of compaction.

(i) Improper or insufficient distribution of blows over the soil surface.

(j) Tendency to press the head of the rammer against the specimen before letting the weight fall.

(k) Insufficient drying of sample for water content determination.

(2) One-point and two-point compaction test.

The possible sources of errors for the one-point and two-point compaction test are essentially the same as those for the five-point method discussed in (1) above. In addition, appreciable inaccuracy in results may occur for both methods if attempts are made to extrapolate maximum density and optimum water contents from non-uniform families of compaction curves (fig. B-5).

B-5. Field compaction and test sections.

For most soils, laboratory densities, water contents, and strength characteristics can be satisfactorily reproduced in a field-compacted backfill. However, during the initial stage of construction frequent checks of density and water content should be made for comparison with design requirements and adjustments should be made in the field compaction procedure as necessary to ensure adequate compaction.

a. When a compacted backfill is constructed as foundation support for critical structures, or when other requirements, materials, and conditions are unusual, the specifications may provide for the construction of test sections. The test section is used to determine the best procedures for processing, placing, and compacting the materials that will produce compacted backfill having engineering properties compatible with design requirements. Therefore, construction of a test section may involve using different types and different weights of compaction equipment, using different lift thicknesses, using different amounts of compaction applications (different numbers of passes or coverages), processing materials differently with respect to water content control, and mixing to obtain improved gradation. A discussion on test sections for shale materials is presented in Appendix A of FHWA-RD-78-141 and illustrates a wide variation in test results, even for very carefully conducted field tests.

b. By exercising rigid control over the water content, processing, placement, and compaction procedures, by frequent density sampling, by keeping complete

records of the procedures and tests, and then by studying and evaluating these records, a procedure to use on the job can be established. In addition to water content and density check tests, undisturbed samples should be obtained to determine that the shear and consolidation characteristics are consistent with design requirements. Once control for field conditions has been established, the backfill can proceed at a normal rate. The contractor should be required to adhere to the established processing, placement, and compaction procedures.

- c. If provisions for construction of a test section

are not contained in the specifications, the field engineers and inspection personnel should provide maximum guidance to the contractor to aid him in establishing adequate processing, placement, and compaction procedures. To meet this problem the contractor must be provided with suggested improvements of equipment type, if they have not been specified, and procedures during the initial stages of backfill operations. The establishment of the procedures and equipment type that will produce adequate compaction of the backfill material must be supported by a comprehensive program of control testing.

Section B-3. FIELD MOISTURE-DENSITY TEST METHODS

B-6. General. Field density measurements of the compacted backfill are essential to ensure that backfill meets the required design densities necessary for the proper functioning of the structure within that backfill. Although water content requirements are not generally specified in military specifications, the measurement and control of water content is important in obtaining required densities. The four density measurement test methods used for the Corps record and contract acceptance enforcement are listed below.

- a. The sand-cone method as described in MIL-STD-621A (Method 106) and ASTM D 1556.

- b. The rubber-balloon method as described in ASTM D 2167.

- c. The nuclear moisture-density method as described in ASTM D 2922 (for density) and ASTM D 3017 (for water content).

- d. The drive-cylinder method as described in MIL-STD-621A (Method 102) and ASTM D 2937 for soft, fine-grained cohesive soils. The water-displacement method described in EM 1110-2-1911, although not currently used for Corps contract enforcement, may be used for supplementary density testing for rocky materials. Rapid field methods of determining or approximating water content-density are also discussed in the following paragraphs.

B-7. Water content and density test methods. Field density can be determined by direct or indirect methods. In the direct methods, the weight of soil removed from a hole and the volume of the hole are determined and used to compute the density. In the indirect methods, a characteristic of the soil, such as radiation scattering or penetration resistance, is measured with an instrument such as a nuclear density meter or penetrometer, and then a previously determined relation between density and the characteristic measured is used to determine the density.

- a. *Direct methods.* The sand-displacement method is considered to be the most reliable direct

method and should be used as the standard test by which indirect test results are correlated with density. Other direct methods are the drive-cylinder method, rubber-balloon method, and water-displacement method.

- (1) *Sand-cone method.* Procedures and equipment for the sand-cone method are described in MIL-STD-621A (Method 106) and ASTM D 1556. The procedure as described in the references involves preparation of the ground surface, measurement of an initial volume for the purpose of correcting for surface irregularities, and measurement of a second volume after a small hole is dug. The difference in the volumes is the volume of the hole. The sand used is a standard sand (Ottawa or other sands having rounded grains and a uniform gradation) that has been calibrated for weight versus volume occupied when falling from a standard, constant height. The weight of sand used is measured by weighing the sand density cylinder before and after each volume measurement, and the volume is determined from the weight versus volume calibration. The soil removed from the hole is weighed, the water content determined (MIL-STD-621A), and the dry weight computed. The wet density and dry density of the soil are computed by dividing the appropriate weights by the computed volume. The sand-cone method can be used to determine the in-place density of practically all soils except those containing large quantities of large gravel sizes.

- (2) *Drive-cylinder method.* Procedures and equipment for the drive cylinder method are described in detail in MIL-STD-621A (Method 102) and ASTM D 2937. The procedure consists of driving a 3-inch-diameter by 3-inch-high sampling tube of known volume into the soil, excavating the sampling tube and soil, and trimming off the soil protruding from the ends of the tube. The weight and water content of the soil are measured and the dry weight is computed. The wet density and dry density of the soil are computed by dividing the appropriate weights by the computed volume. The drive-cylinder method is limited to moist, fine-grained cohesive soils.

(3) *Rubber-balloon method.* Procedures and equipment for the rubber-balloon method are described in ASTM D 2167. This method utilizes a rubber balloon attached to a glass or metal cylinder containing water and having a scale graduated in cubic feet. An annular device is seated on the prepared ground surface, and the balloon apparatus is placed and held down firmly on the ring. Then water is forced into the balloon under pressures of 2 to 3 pounds per square inch to obtain an initial volume measurement to correct for ground surface irregularities. The apparatus is removed, a small hole is dug, and the apparatus is replaced on the ring. Water is again pumped into the balloon and causes the balloon to conform to the boundary of the hole; then the volume is measured. This volume less the initial volume is the volume of the hole. The volumeter apparatus is simple and easy to operate, and the volume measurement can be made directly and in somewhat less time than that with the sand-cone volume apparatus. The results obtained are considered to be as accurate as those obtained from the sand-cone apparatus. Like the sand-cone method, the rubber-balloon method can be used to determine the in-place density of practically all soils except those containing large quantities of large gravel sizes.

(4) *Water-displacement method.* Where it is necessary to determine the in-place density for a large volume of soil, as in coarse-grained soils containing significant quantities of large gravel sizes, an approximate density can be obtained by excavating a large hole (several cubic feet) and determining the volume by lining the hole with thin plastic sheeting and measuring the quantity of water required to fill the hole. A relatively small sample representative of the material from the excavation is used for determining the water content. Using the wet and dry weights of the material excavated and the measured volume of the hole, the wet and dry densities of the soil can be determined. Although the procedure is not contained in a Military Standard, it is about the only means of determining an approximate density for soils with large sizes of gravel or rock.

b. Size and preparation of test hole. The size of the hole and the care used in preparing the test hole for the sand volume and balloon methods influence the accuracy of the volume measurement. The proper size of the hole is not well established; however, the larger the hole, the less significant small errors in measurement of volume become. The instructions in TM 5-824-2 indicate that a volume of at least 0.05 cubic foot should be used when testing materials with a maximum particle size of 1 inch and that larger volumes should be used for larger maximum particle sizes. ASTM D 1556 suggests certain relations between particle size and the test hole volume and weight of water content specimen. It also

recommends increasing the size of the sample used for water content determination with increasing maximum particle size. The relations suggested by the American Society for Testing and Materials are shown in the following tabulation:

Maximum particle size, in.	Minimum test hole volume	Water content sample
	cu ft	g
0.187 (No. 4)	0.025	100
1/2	0.050	250
1	0.075	500
2	0.100	1,000

For significant quantities of larger particles the volumes above should be doubled. The accuracy of the test results is influenced by not only the care taken in preparing a test hole but also the degree of recovery of the excavated material. A hole with irregular surfaces will cause the volume measurement to be less accurate than a hole with smooth surfaces. Thus, the inside of the hole should be kept as free of pockets and sharp projections as possible. Digging a smooth test hole in cohesionless coarse-grained material is particularly difficult. In fine-grained soils without gravel particles, the hole may be bored with an auger, but hand tools will be required to smooth the walls and base of the hole and to recover loose material. For coarser-grained soils and soils containing a significant amount of gravel-size particles, hand tools will generally be required to excavate the hole to prevent disturbing the material in the walls and base of the test hole. Should it become necessary in digging a test hole in highly compacted material to loosen the material by using a chisel and hammer, care must be taken not to disturb the soil around the limits of the hole. All loose particles must be removed after the final depth has been reached, and all particles must be recovered. All soil should be placed in a waterproof container as the soil is taken from the hole. This measure will prevent loss of water before the soil can be weighed.

c. Indirect methods. The indirect methods include use of the nuclear moisture-density apparatus, Proctor penetrometer, and cone penetrometer. Both the Proctor penetrometer and cone penetrometer methods for determining the density require very careful calibration using soils of known density and water content, and considerable experience in operating the device; even so, the accuracy of these methods may be subject to question because of the great influence that non-uniformity of water content or a small piece of gravel can have on the penetration resistance. The Proctor penetrometer may also be used to approximate water content of fine-grained soils.

(1) *Nuclear moisture-density method.*

Procedures and equipment for the nuclear moisture-density method are described in ASTM D 2922 (for density) and ASTM D 3017 (for water content). The three methods for determining in-place densities described in ASTM

D 2922 are Method A-Backscatter, Method B-Direct Transmission, and Method C-Air Gap. Of the three methods, Method B-Direct Transmission is recommended over Method A and Method C because it eliminates the effect of vertical density variations.

(a) Modern nuclear-moisture density equipment incorporates a radioactive source emitting neutrons and gamma rays and measuring elements (geiger tubes) or "scalers" into a single, self-contained unit. The determination of moisture by the nuclear method is dependent on the modifying of high energy or "fast" neutrons into low energy or "slow" neutrons (ASTM, STP No. 293). Any material containing hydrogen will moderate fast neutrons. Since hydrogen is present primarily in the molecules of free water, the degree of interaction between the fast neutrons and hydrogen atoms represents a measure of the water content of the soil. Density measurements are based on the scattering of gamma rays by the orbital electrons on the atoms comprising the soil. Since the scattering is a function of the electron density, which in turn is approximately proportional to the density of the soil, it is possible to correlate the backscatter of the gamma rays with the soil density.

(b) To obtain a water content or density measurement, the appropriate meter is set in place and the voltage setting is adjusted to the correct operating voltage. After the scaler is turned on, a short warmup period (not exceeding 1 minute) is allowed before the test count is started. Intimate contact at the interface between meter and soil is necessary for Method A Backscatter because the scattering of the gamma rays for the density measurement is quite sensitive to even minute air gaps. The normal counting period is 1 minute, with one or two repeat counts taken as a check. Calibration curves for both moisture and density determinations, once the count rates have been established, are furnished by the manufacturers for each individual unit. In general, the calibration curve for moisture determination is more reliable than the curve for density determination. However, it is advisable to correlate both calibration curves on each type of soil with which the instrument is to be used. Such a correlation should be accomplished by using current standard methods for moisture and density determinations or by calibrating on blocks of material of known moisture and density. Examples of calibration for shale materials are given in Appendix A of FHWARD-78-141.

(c) For all nuclear-moisture density devices, separate standards are provided so that the count rate can be determined on each instrument at any time in the field. A standard count should be taken three or four times during a day's operation. Although adjustments can generally be made on the instruments so that the count will coincide with the standard count,

even a slight adjustment is not usually justified. A more satisfactory procedure is to record the field measurement in terms of percent of this standard count rate, which should be within a reasonable percentage (+ 5) of the given reference count. Use of the percent of standard count, rather than simply the counts per minute, is recommended for increased accuracy. Use of this procedure largely cancels out the effects of such variables as reduction in source strength, background count, and changes in sensitivity of the detector tubes.

(d) The calibration curve for the soil being tested is entered with the value of the density meter count rate (taking into consideration the variation from the standard count) to obtain the wet unit weight of the soil. Similarly, the moisture meter yields the weight of water per cubic foot of soil. The unit dry weight of the soil is simply the wet unit weight obtained by the density meter minus the weight of water obtained by the moisture meter. By dividing the water measurement by the dry density, the water content can be expressed in the more familiar terms of percentage of dry weight.

(e) Anyone working with nuclear meters must recognize that a possibility of exposure to radiation exists if the safety rules listed by the manufacturer are not followed. When proper procedures and safety rules are followed, the radiation hazard is negligible. For certain instruments, operating personnel must wear a body radiation film badge and carry a pocket dosimeter. These instruments must be ready weekly to ensure that the maximum permissible weekly dosage is less than 100 milliroentgen. Other safety rules deal with handling the devices and being aware of the built-in safety devices. The safety precautions mentioned above may vary or not be applicable for some of the newer devices being manufactured. Therefore, the manufacturer's literature should be carefully studied to determine appropriate safety requirements.

(f) It is possible, using nuclear-moisture density apparatus, for one inspector to conduct perhaps 30 water content and 30 density tests per 8-hour working day. The time required per test is only 20 or 25 percent of that required in direct sampling methods. A large number of tests with the nuclear meter correlated with a much smaller number of direct sampling determinations can be of great benefit in ensuring that adequate compaction of the backfill is being obtained. A simple statistical analysis of the data can be made, such as a plot of dry density versus number of tests (ASTM STP No. 293). The resulting bell-shaped curve is a very useful tool since each day's results can easily be added to the plot of previous test results. This procedure can provide an up-to-date picture of the fill densities being obtained and can show the effect of changes made in field compaction procedures.

(2) *Hand cone penetrometer.* The hand cone penetrometer offers a rapid means of checking density requirement of some compacted backfills. The process involves the correlation of penetration resistance with known in-place densities as determined by either the sand-cone or the rubber-balloon method.

(a) Cone penetration resistance is a measurement of soil bearing capacity. Since bearing capacity is dependent on shear strength and thus density, the hand cone penetrometer is an indirect measurement of density. Because shear strength is a function of any pore air and pore water pressures that may be generated by a shearing action of soils containing pore water, the method is applicable only to free-draining materials where pore pressures are dissipated as fast as they are generated. Penetration resistance can also be drastically influenced by the obstruction of gravel size particles. Therefore, the method is applicable only to sands with 100 percent passing the U.S. Standard No. 4 sieve (4.76 mm) and no more than 15 percent passing the U.S. Standard No. 200 sieve (0.074 mm).

(b) A plot of hand-cone sounding resistance versus depth of sounding will result in an approximate linear relationship for homogenous materials of relatively constant density for depths of sounding ranging from approximately 2 inches to 20 inches depending on the geometry and size of the cone point and material type. Correlations may be made between known in-place densities and either the angle of inclination between sounding resistance and depth of penetration or the sounding resistance at a given depth. The range of known in-place density must be sufficient to establish a trend between sounding resistance and density. Correlations between density and sounding resistance at a given depth is the simplest correlation since the angle of inclination does not have to be computed. Figure B-7 shows a case example of a correlation between dry density and sounding resistance measured at 6 inches below the surface. Contract specification required a minimum acceptable dry density of 104.7 pounds per cubic foot (98 percent of the maximum dry density according to the compaction method described in ASTM D 1557). Figure B-7 also indicates that all soundings with resistances of 110 pounds or more corresponded to densities greater than 104.6 pounds per cubic foot. Therefore, no additional standard density checks are needed beyond the routine tests. When all soundings with resistance of 86 pounds and below correspond to densities below 104.6 pounds per cubic foot, it is evident that sufficient compaction has not been achieved and additional standard density checks are definitely needed for an acceptance or rejection decision. Sounding with resistances between 86 and 110 pounds may or may not need additional density checks depending on whether the inspector has reason to suspect adequate compaction has or has not been achieved.

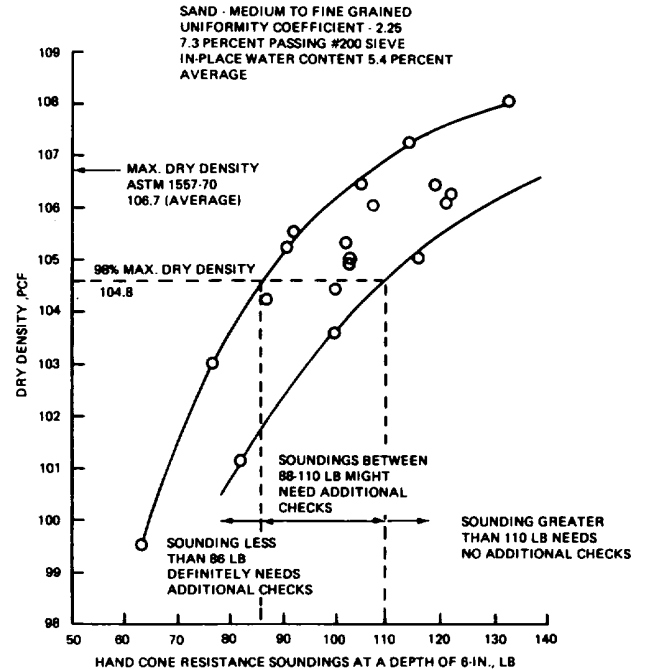

Figure B-7. Correlation between dry density and hand cone resistance at a depth of 6 inches below the surface.

(c) The correlation between sounding resistance and known in-place dry densities (fig. B-7) is made directly without knowing water content at each sounding location. Although sounding resistances are affected by water content for the dry, moist, and 1 to 2 percentage points above optimum state, the range of possible water content in the moist state does not significantly affect sounding resistance.

(d) The hand cone penetrometer is ideally suited for use in confined zones where sand is used as backfill and where rapid control aids are needed to determine if adequate compaction has been achieved. With a little practice, a hand-cone sounding can be made in less than 1 minute.

d. *Possible sources of errors.* Since the decision to accept or reject a particular part of a backfill is primarily dependent upon the results of in-place density control tests, it is important for the inspector to be familiar with the possible sources of errors that might cause an inaccurate test result. Some of the more likely sources of errors for the sand-cone, rubber-balloon, and nuclear moisture-density methods are discussed below. All tests that are suspected to be in error must be repeated.

(1) *Sand-cone method.* The major sources of possible error are as follows: (a) The sand-cone method relates the bulk density of a standard sand to the known weight of the

same sand occupying an in-place volume of sampled material. Changes in effective gradation between or within batches of sand may significantly affect the test results. This error can be minimized by frequent calibration of the sand's bulk density.

(b) Loose sand increases in density when subjected to vibrations. Care must be taken not to jar the sand container while calibrating bulk density in the laboratory or during in-place volume measurements in the field. A common error is to use the sand cone method for in-place volume measurements adjacent to the operation of heavy equipment. Heavy equipment can generate vibrations that densify the sand and result in erroneously high-volume measurements and low in-place densities.

(c) Appreciable time intervals between bulk density determination of the sand and its use in the field may result in change in the bulk density caused by a change in the moisture content of the sand.

(2) *Rubber-balloon method.* The major sources of possible error are as follows: (a) New rubber-balloon volumeters should be calibrated against several known volumes of different sizes covering the volume range of in-place measurements.

(b) For stiff soils such as clay, it is possible to trap air between the sides of the sample hole and balloon. This error can be minimized by placing lengths of small-diameter string over the edge of the hole and down the inside wall slightly beyond the bottom center.

(c) The application of the 2- to 3-pounds-per-square-inch pressure to extend the balloon into existing irregularities in the hole will cause a noticeable upward force on the volumeter. Care must be taken to ensure that the volumeter remains in intimate contact with the base plate.

(d) The rubber balloon must be frequently checked for leaks.

(3) *Nuclear moisture-density method.* The major sources of possible error are as follows:

(a) The single consistent source of error is related to the accuracy of the system. The overall system accuracy in determining densities is statistical in nature and appears to vary with the equipment used, test conditions, materials tested, and operators. If proper procedures are followed, the standard deviations in terms of accuracy will vary on the order of 3 to 5 pounds per cubic foot for density tests and 0.5 to 1.0 pound of water per cubic foot of material for water content tests.

(b) Manufacturers furnish calibration curves for each piece of equipment. Due to the effects of differing chemical compositions, calibration curves may not be applicable to materials not represented in establishing the calibration curve. Apparent variations in calibration curves may also be induced by differences in

the seating, background count, sample heterogeneity and surface texture of the material being tested.

B-8. Rapid field water content control procedures. In many cases, particularly in confined zones, it is important to rapidly determine the dry density of a given part of the backfill in order to prevent the possibility of costly tear out and rebuild operations. The test procedures for determining dry densities using the sand-cone and rubber-balloon methods sometimes require extensive drying times (depend on material type up to 16 hours) to determine water content. Alternate techniques for rapidly determining water content are discussed below.

a. *Microwave ovens.* Microwave energy may be used to dry soil rapidly and thus enable quick determination of water content (ASTM STP No. 599). However, in drying soils with microwaves, the only control on the amount of energy absorbed by the soil is exposure time; consequently, if soils are left in the oven too long, severe overheating can occur. This overheating of the soil can cause bound water, a part of the soil structure, to be driven off and thus result in significant errors in water content measurements. In addition, continuous heating can result in excessive heat being generated; certain soils have been observed to fuse or explode and thereby create hazards to both equipment and personnel.

(1) Times required for drying in a microwave oven are primarily governed by the mass of water present and the power-load output of the oven, as expressed by

$$GT = \frac{M_w[(0.2/w + 1)(100 - t_o) + 539](4.18896)}{P} \quad (B-1)$$

where

T = time in the microwave oven, seconds

M_w = mass of water present in the soil-water mixture, grams

w = water content of the specimen

t_o = initial temperature of the soil-water mass, degree Centigrade

P = power output of the oven, watts

This governing equation indicates that in order to predict accurately the drying times required, an estimate of the specimen water content must be made and the oven power versus load relationship must be established by calibration.

(2) The limitation of having to estimate the initial water content of the specimen is not insurmountable. Test results indicate that slight overestimations of the actual water content, i.e., longer drying times, generally result in small differences between conventional oven and microwave oven water contents. Conversely, underestimations of water content result in more serious errors. If an accurate estimate of water content

cannot be made, experience has shown that close visual observation often can be used to determine if soil overheating is occurring. An alternative approach is to incrementally dry a duplicate specimen until a constant weight is obtained, calculate the water content, and input this value into equation (B- 1).

(3) The useful power output "P" is determined in the laboratory by subjecting a mass of distilled water to microwaves for a given time and then measuring the rise in temperature induced in the water. Power in watts is calculated from

$$P = \frac{M_w t}{T_c} 4.18896 \quad (B-2)$$

where

- MW = mass of distilled water in the oven, grams
- t = increase in temperature of the distilled water, degree Centigrade
- T_c = time in the oven for calibration, seconds

A plot is then made of power output and oven load (mass of water in oven) in grams of water as shown in figure B-8.

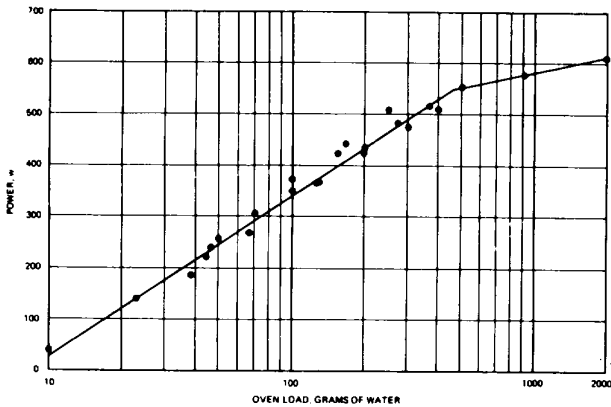

Figure B-8. Power Applied by the Oven to Dry Moist Soils.

(4) The water content estimate is used to calculate the mass of water in the specimen from

$$MW = \frac{(W_{wet}) (W)}{(1 + w)} \quad (B-3)$$

where

- M_w = mass of the water in the specimen, and equivalent to oven load in figure B-8, grams
- W_w,t = wet weight of the specimen, grams

By calculating M_w (oven load in fig. B-8) from equation (B-3) and finding a comparable value of power from a plot similar to figure B-8 for the particular oven used, the drying time may be calculated from equation (B-1).

(5) It may not be possible to successfully dry certain soils in the microwave oven. Gypsum may decompose and dehydrate under microwave excitation. Highly metallic soils (iron ore, aluminum rich soils, and bauxite) have a high affinity for microwave energy and overheat rapidly after all the free water has been vaporized. Hence, extreme care is required when drying these soils. For the same reason, metallic tare cans or aluminum plates are not permissible as specimen containers.

(6) Because microwaves are a type of radiation, normal safety precautions to avoid undue exposure should be observed.

b. *Proctor penetrometer.* The Proctor penetration resistance method in the hands of inspection personnel experienced in its use provides a rapid expedient check on whether the field water content is adequate for proper compaction. However, the method is suitable only for fine-grained soils because coarse sand or gravel may cause erroneously high resistance readings. The method consists of compacting by the procedure used for control of a representative sample of soil taken from the loose lift being placed. The compacted specimen is weighed, and the wet unit weight is determined. The penetration resistance of the compacted specimen in the mold is then measured with the soil penetrometer. The moisture content can then be estimated by comparing the penetration resistance of field compacted specimens with a relation previously established in the laboratory between wet unit weight, penetration resistance, and moisture content. The procedure requires about 10 minutes and is sufficiently accurate for most field purposes. The procedure to determine the relation between wet unit weight, penetration resistance, and moisture content is described in ASTM D 1558. The relation is generally developed in conjunction with the compaction test.

c. *Other methods.* Other methods for determining water content include drying by hot plate or open flame, drying by forced hot air and a rapid moisture test that uses calcium carbonate. In the hot plate method, a small tin pan and a hot plate, oil burner, or gas burner (something to furnish fast heat) are used. A sample of wet soil is weighed, dried by one of the above mentioned methods, and weighed again to determine how much water was in the sample. This method is fast, but care must be taken to ensure that the material is thoroughly dry. Also, if both organic matter and bound water are removed, higher water content determinations than those obtained by oventrying sometimes result. In the forced hot air, a sample is placed in

a commercially available apparatus containing an electric heater and blower. Hot air at 150 to 300 degrees Fahrenheit is blown over and around the sample for a preset time. A 110- or 230-volt source is required. Available sizes of apparatus can accommodate sample

weights from 25 to 500 grams. Drying times are estimated to vary from 5 minutes for sand to as long as 30 minutes for fat clay. The rapid moisture test and limitations are described in STP 479.

APPENDIX C

BIBLIOGRAPHY

-
- Broms, B., "Lateral Earth Pressures Due to Compaction of Cohesionless Soils". *Proceedings, Fourth Budapest Conference on Soil Mechanics and Foundation Engineering*, Budapest, Hungary (1971).
- Burmister, D. M., "The Grading-Density Relations of Granular Materials". *Proceedings, American Society for Testing and Materials*, Volume 38, Part II, Philadelphia, Pennsylvania (1938).
- Davis, F. J., "Quality Control of Earth Embankments". *International Conference on Soil Mechanics and Foundation Engineering*, Volume 1, Switzerland (1953).
- de Mello, U. F. B., Sonto Silveira, E. B., and Silveira, A., "True Representation of the Quality of a Compacted Embankment". *First Pan-American Conference on Soil Mechanics and Foundations Engineering*, Volume II, Mexico (1960).
- Hilf, J. W., "Compacting Earth Dams with Heavy Tamping Rollers". *Journal of the Soil Mechanics and Foundations Division, American Society of Civil Engineers*, Volume 83, No. SM2, Paper 1205, Ann Arbor, Michigan (1957).
- Ingold, T. S., "The Effects of Compaction on Retaining Walls". *Geotechnique*, Volume 29, No. 3. London (1979).
- Ingold, T. S., "Retaining Wall Performance During Backfilling". *Journal of the Geotechnical Engineering Division, American Society of Civil Engineers*, Volume 105, GT5, Paper 14580, New York, New York (1979).
- Li, C. Y., "Basic Concepts on the Compaction of Soil". *Journal of the Soil Mechanics and Foundations Division, American Society of Civil Engineers*, Volume 82, SM1, Paper 862, Ann Arbor, Michigan (1956).
- Joshi, R. C., Duncan, D. M. and Durbin, W. L., "Performance Record of Fly Ash as a Construction Material". *Proceedings, Fourth International Ash Utilization Symposium*, St. Louis, Missouri, 24-25 March 1976. John H. Faber, editor, Energy Research and Development Administration Morgantown, West Virginia (1976) (NTIS: MERC/SP-76/4).
- Olson, R. E. "Effective Stress Theory of Soil Compaction". *Journal of the Soil Mechanics and Foundations Division, American Society of Civil Engineers*, Volume 89, No. SM2, Paper 3457, Ann Arbor, Michigan (1963).
- Plantema, G., "Influence of Density on Sounding Results in Dry, Moist, and Saturated Sands". *Proceedings of the Fourth International Conference on Soil Mechanics and Foundation Engineering*, Long Volume I (1957).
- Proctor, R. S., "The Design and Construction of Rolled Earth Dams". *Engineering News-Record*, Volume m (1933).
- Quigley, D. W. and Duncan, J. M., "Earth Pressures on Conduits and Retaining Walls". Report No. UCB/GT/78-06, University of California, Department of Civil Engineering (1978).
- Turnbull, W. J. and Foster, C. R., "Stabilization of Materials by Compaction". *Journal of Soil Mechanics and Foundations Division, American Society of Civil Engineers*, Volume 82, No. SM2, Paper 934, Ann Arbor, Michigan (1956).
- Winterkorn, H. F. and Fang, Hsai-Yang, *Foundation Engineering Handbook*. Van Nostrand Reinhold Company, New York, New York (1975).

The proponent agency of this publication is the Office of the Chief of Engineers, United States Army. Users are invited to send comments and suggested improvements on DA Form 2028 (Recommended Changes to Publications and Blank Forms) direct to HQDA (DAEN-ECE-G), WASH DC 20314.

By Order of the Secretaries of the Army and the Air Force:

Official:

ROBERT M. JOYCE
Major General, United States Army
The Adjutant General

E. C. MEYER
General, United States Army
Chief of Staff

Official:

JAMES L. WYATT, JR., *Colonel, USAF*
Director of Administration

CHARLES A. GABRIEL, *General, USAF*
Chief of Staff

DISTRIBUTION:

Army: To be distributed in accordance with DA Form 12-34B, TM 5-800 Series requirements for Engineering and Design for Real Property Facilities.

Air Force: F

★U.S. GOVERNMENT PRINTING OFFICE: 1996-406-421/50090

TB 9-6625-798-35,

CALIBRATION PROCEDURE FOR OSCILLOSCOPES AN/USM-140 AND AN/USM-141 (HEWLETT - PACKARD MODELS 170 AND 170AR). AN/USM-140A (HICKOK INSTRUMENT CO., MODEL 1807); AN/USM-140B AND AN/USM-141A (HEWLETT - PACKARD MODELS 170B AND 170BR); AN/USM-104C AND AN/USM-141B (HICKOK INSTRUMENT CO.); SWEEP DELAY GENERATOR MX-2962/USM (HEWLETT - PACKARD MODEL 166D0 AM-3568/USM (HEWLETT - PACKARD MODEL K01 - 166F); DUAL - TRACE PREAMPLIFIER MX - 22930A/USM (HEWLETT - PACKARD MODEL 162A); MX - 2721/USM-105 (HEWLETT - PACKARD MODEL H02 - 162A); AND HICKOK MODEL 1804A - 2); MX - 2930B/USM (HEWLETT - PACKARD MODEL 162C); AND MX - 2930C/USM (HICKOK INSTRUMENT CO.) - 1974.

RECOMMENDED CHANGES TO EQUIPMENT TECHNICAL PUBLICATIONS



THEN... JOT DOWN THE DOPE ABOUT IT ON THIS FORM, CAREFULLY TEAR IT OUT, FOLD IT AND DROP IT IN THE MAIL!

SOMETHING WRONG WITH THIS PUBLICATION?

FROM: (PRINT YOUR UNIT'S COMPLETE ADDRESS)

DATE SENT

PUBLICATION NUMBER

PUBLICATION DATE

PUBLICATION TITLE

BE EXACT... PIN-POINT WHERE IT IS

IN THIS SPACE TELL WHAT IS WRONG AND WHAT SHOULD BE DONE ABOUT IT:

PAGE NO.	PARA-GRAPH	FIGURE NO.	TABLE NO.
----------	------------	------------	-----------

TEAR ALONG PERFORATED LINE

PRINTED NAME, GRADE OR TITLE, AND TELEPHONE NUMBER

SIGN HERE:

DA FORM 2028-2 JUL 79

PREVIOUS EDITIONS ARE OBSOLETE.

P.S.—IF YOUR OUTFIT WANTS TO KNOW ABOUT YOUR RECOMMENDATION MAKE A CARBON COPY OF THIS AND GIVE IT TO YOUR HEADQUARTERS.

PIN NUMBER 025932