

This document downloaded from
vulcanhammer.net vulcanhammer.info
Chet Aero Marine



Don't forget to visit our companion site
<http://www.vulcanhammer.org>

Use subject to the terms and conditions of the respective websites.

ENCE 4610

Foundation Analysis and Design

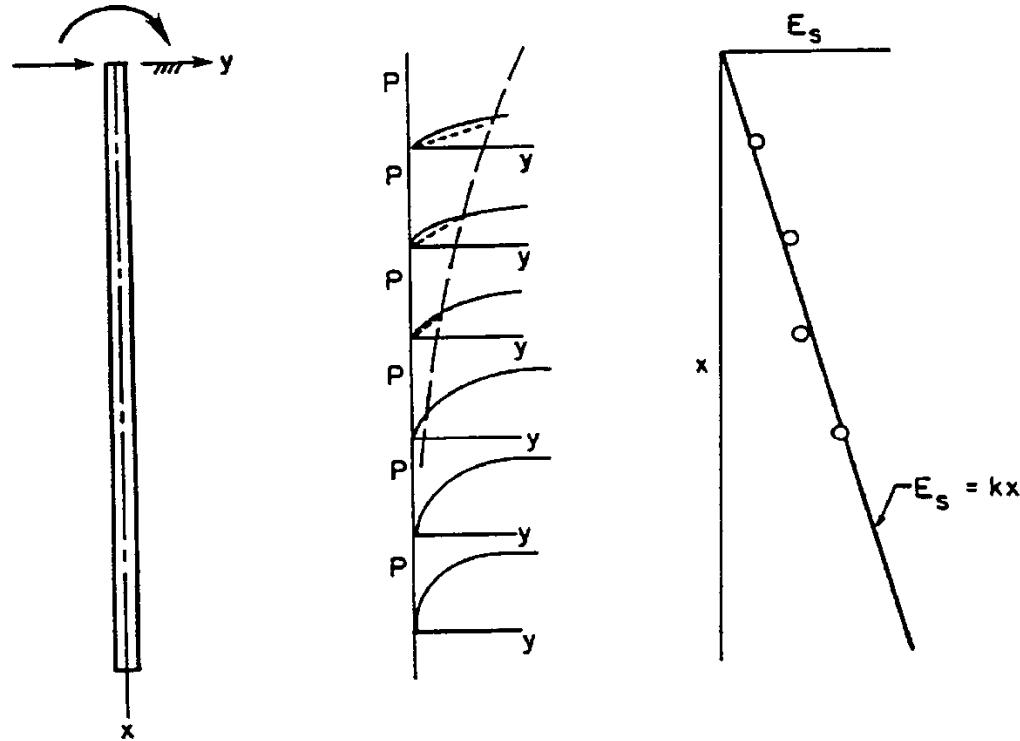

(a) Pile

(b) p - y curves

(c) Soil modulus

Lecture 17

Lateral Loading of Piles
Design of Deep Foundations

Sources of Lateral Loading

- River current and mud movement loads in alluvial settings (foundations subject to scour)
- Ocean wave forces
- Slope movements
- Cable forces on transmission towers
- Earth pressures on retaining walls
- Wind Loads
- Seismic Loads
- Impact Loads from Ships (Berthing, Pier Collision, etc.)
- Eccentric Loads on Columns

Lateral Loading in Piles

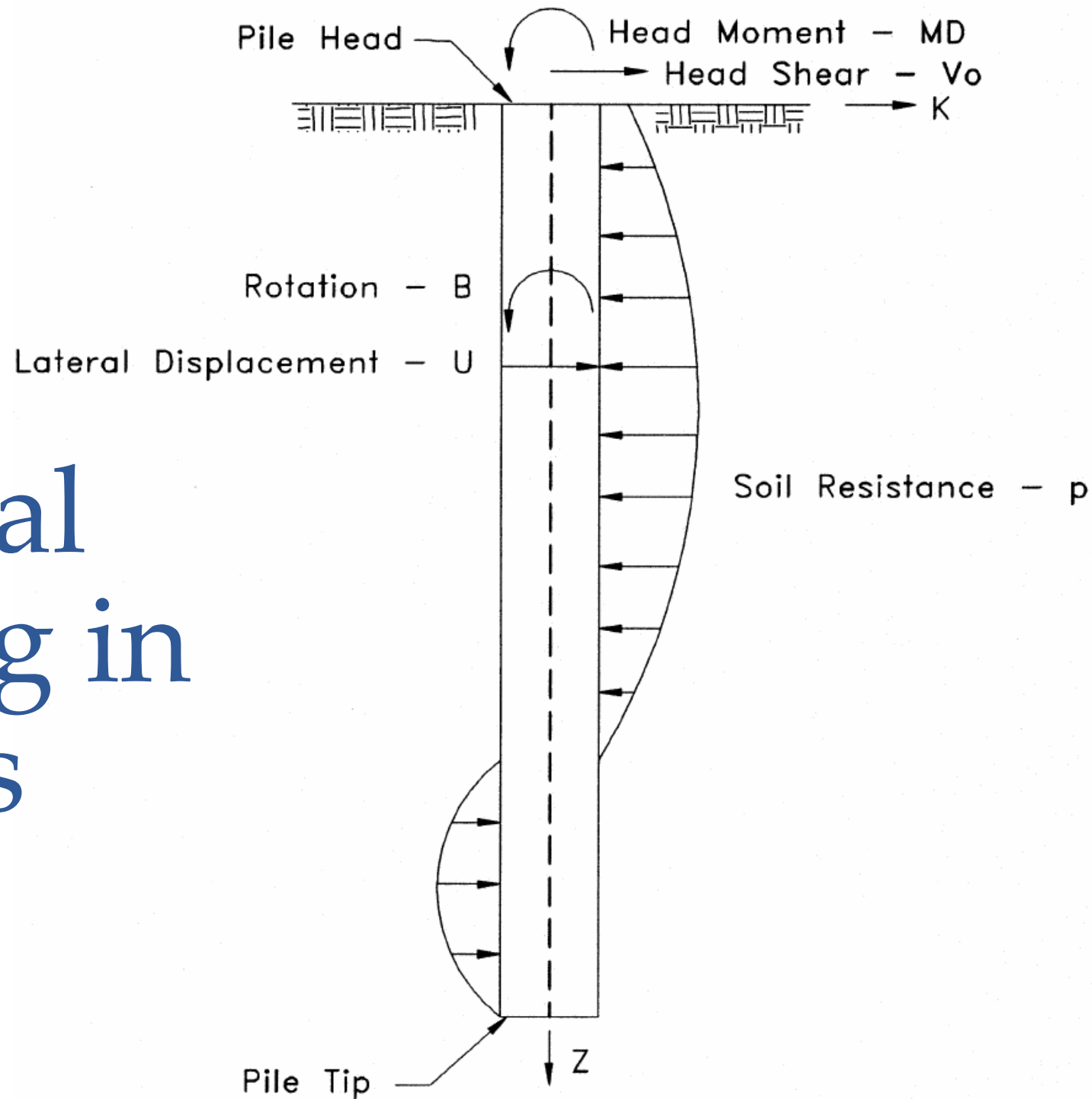

Batter Piles

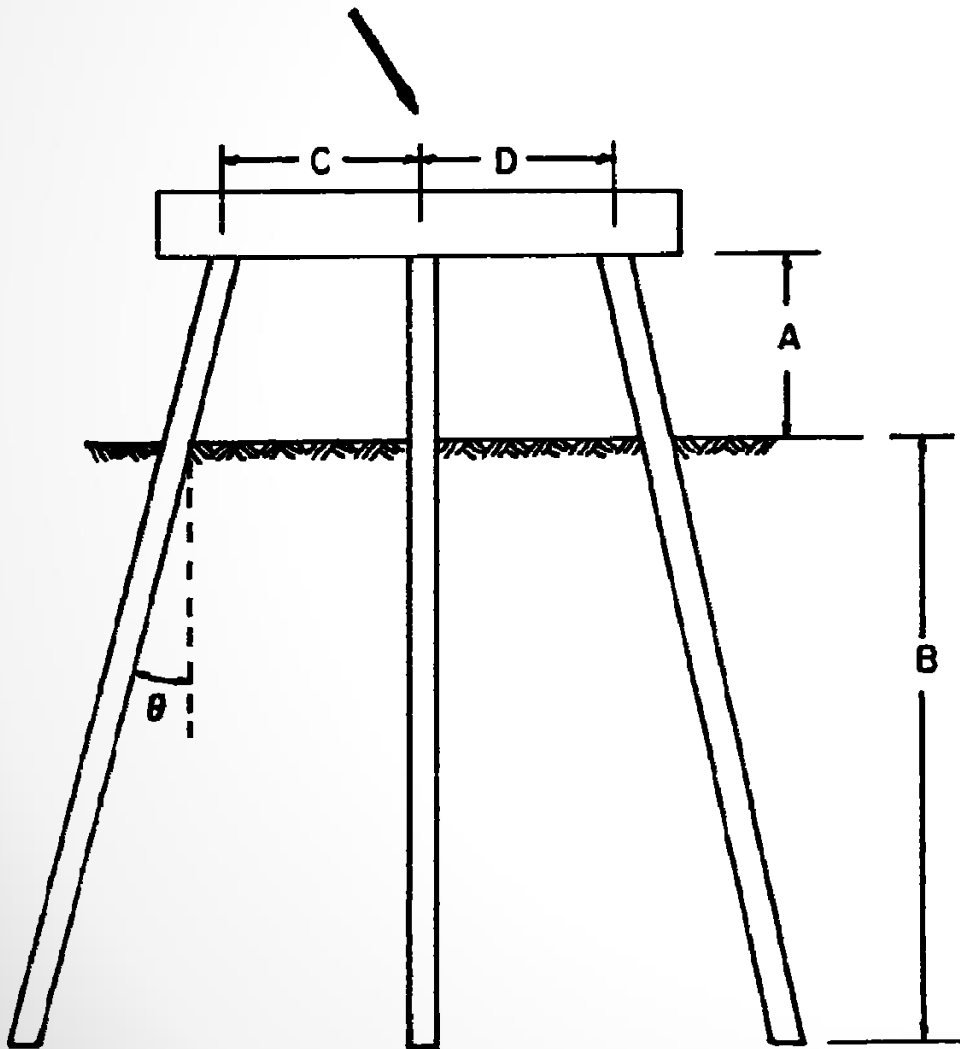

- Basically turn lateral loads into axial loads
- Present challenges in driving and testing
- Form a very stiff system than can pose problems in seismic situations
- Very common solution to lateral loading

Analytic Methods for Lateral Loading

Dividing Line:

Timber – $D/B = 20$

Steel or Concrete – $D/B = 35$

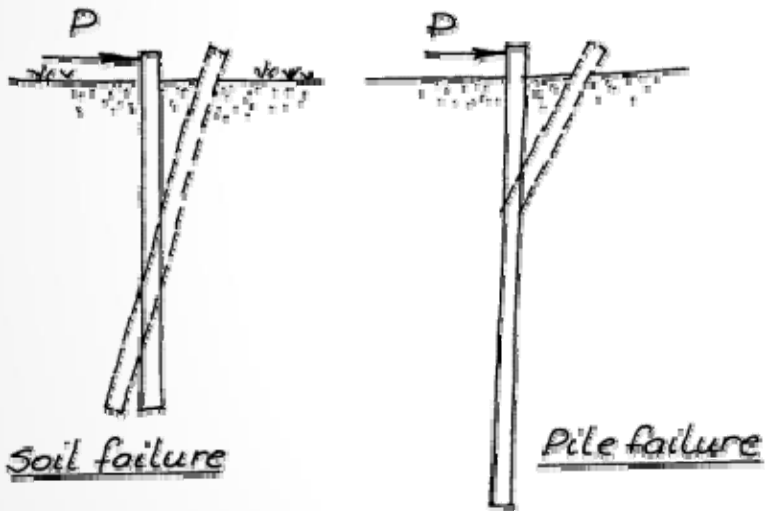

Short Foundations (Rigid) Long Foundations (Beam-Like)

- Rigid Methods (Broms)
 - Used for light weight « short » foundations
 - Same limitations as rigid methods for mat foundations
- Depth to Fixity Methods (Davisson)
 - Only considers a certain depth as flexible
 - Structural engineers could analyse the foundation as a structure once the depth of fixity was known
 - Too simplistic
- Finite Element Analysis
- p-y curves

Compression of Soil in Lateral Loading

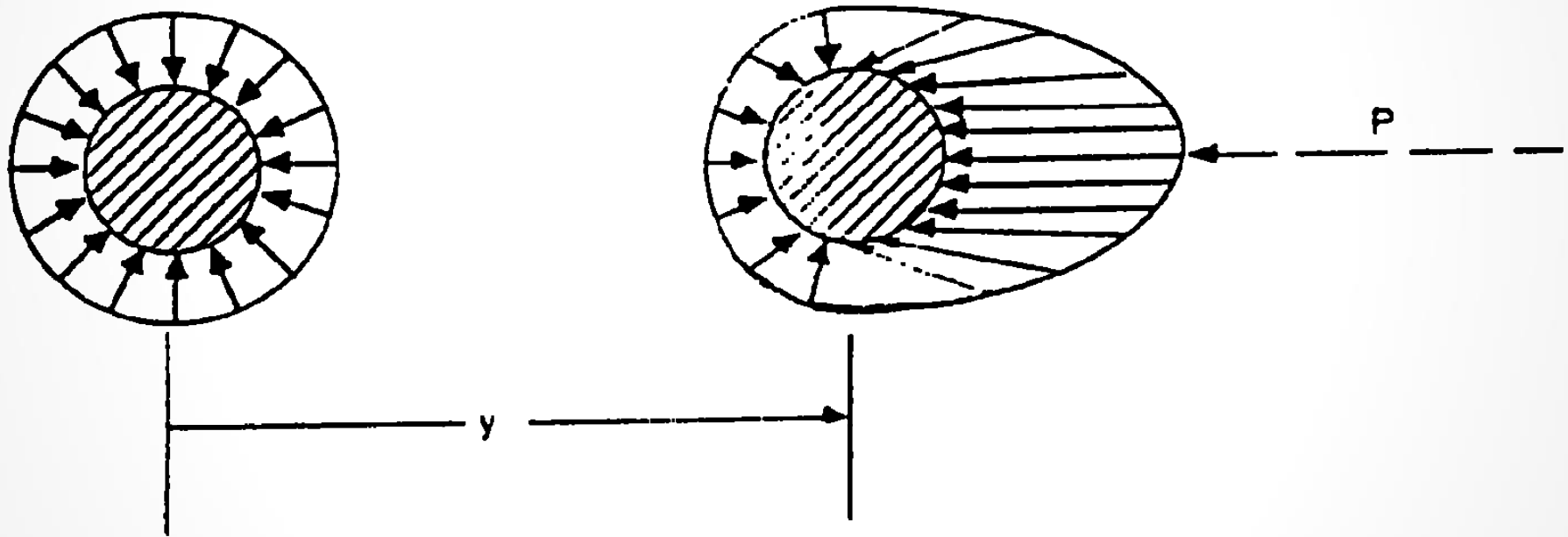

Suction on the load side
Additional stress on the far side

(a) Before bending

(b) After bending

p-y Curves

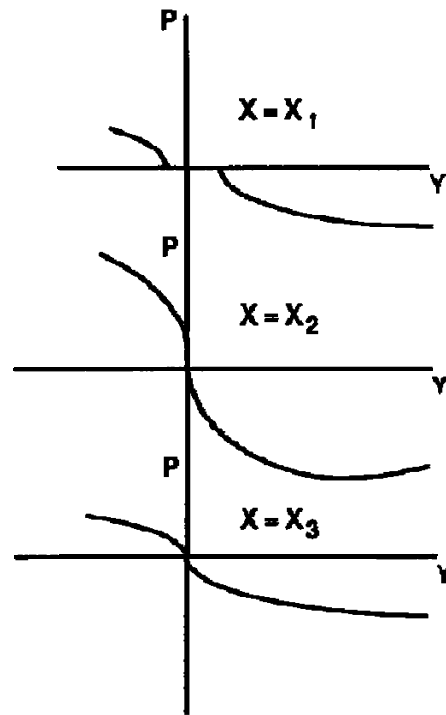
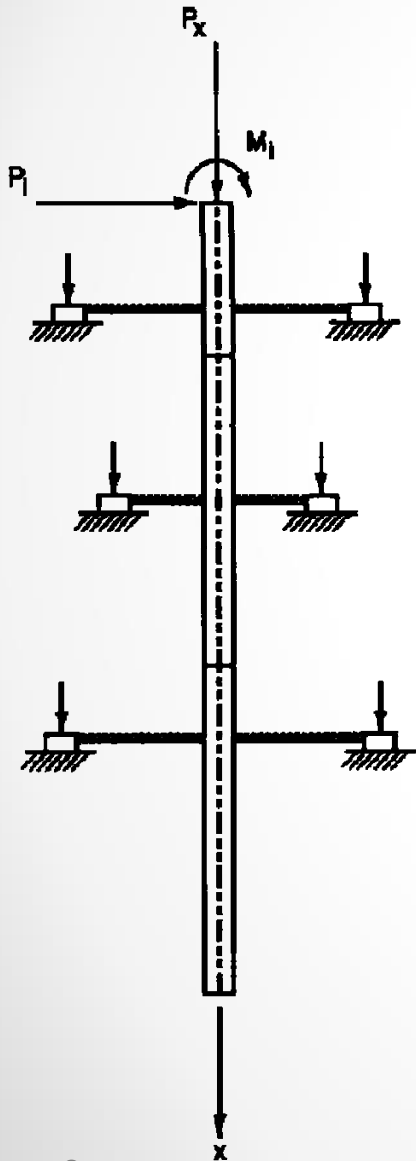

- Take into consideration nonlinear soil characteristics (as opposed to Winkler model)
- Properly require a finite-difference (COM624, LPILE) computer solution
- Non-dimensional and spreadsheet solutions available for common problems

Development of p-y Curves

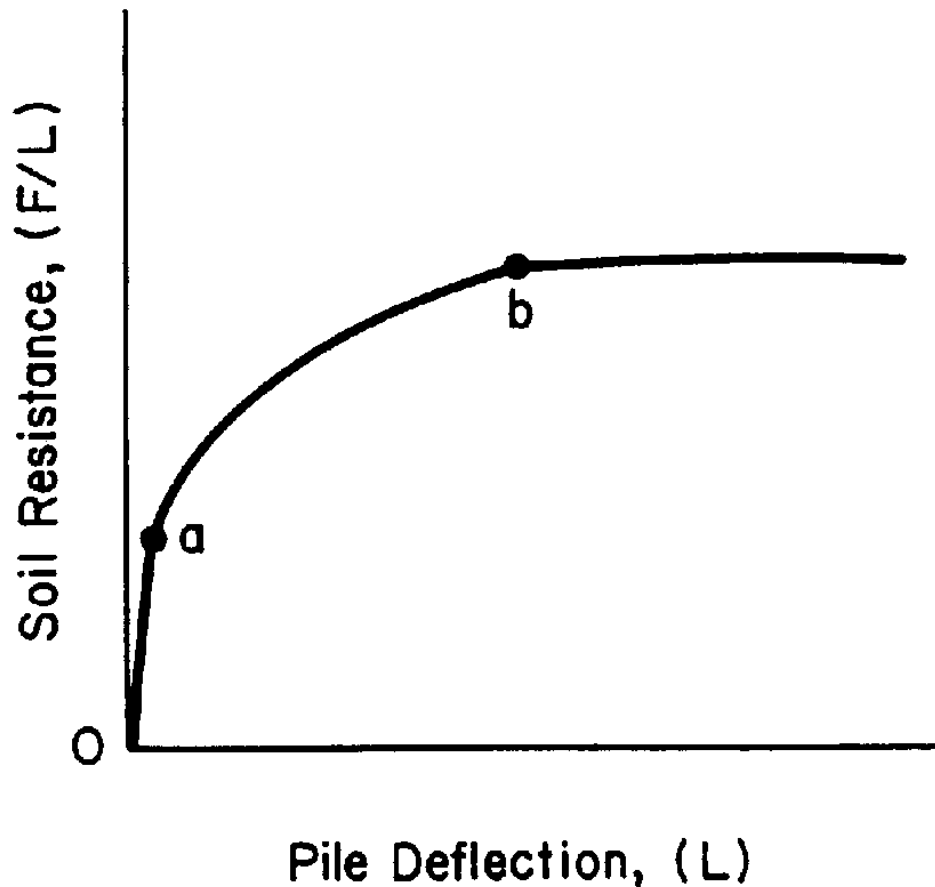

- Empirical Data
 - Based on actual lateral load tests, either on the job site itself or on controlled field tests
- Computer Programs
 - Model the lateral deflection of the pile as a function of depth
 - Take into consideration non-linear soil response
 - Can be difficult to use
- Non dimensional methods based on computer results or empirical data
 - Not as accurate as program, but suitable for estimates or smaller projects

Characteristic Load Method (CLM)

- Based on the COM624G program
- Reduce the variables to nondimensional form
- Advantages
 - Analyses can be done quickly and simply
 - Can determine load-deflection characteristics directly
 - Assumptions
 - Constant EI , s_u or ϕ , and ν for depth of pile
 - Foundation is long enough to be considered fixed at the toe ("long foundation" criterion)
- Three ways of accessing the method
 - Hand calculations, which involve charts and can be tedious
 - CLM2 Spreadsheet, which can analyze both bored and driven piles and pile groups
 - TAMWAVE program, which is easier to input but only valid for single driven pile analysis
- Group Effects
 - Group effects are important with laterally loaded piles as they are with axial ones
 - The effect is usually called the PSPI (pile-soil-pile-interaction), or shadow effect
 - The soil stress created by lateral loads around one pile will extend to the pile's neighbours, depending upon the distance between the piles and the level of stress
 - The lateral capacity of each pile is generally degraded by this effect
 - Methods of solution use p-y curve methods and consider spacings and pile deflections
 - CLM 2.0 Spreadsheet includes group effect calculations

Characteristics Loads and Moments

Pile group efficiency factors were incorporated in the Characteristic Load Method of analysis by reducing the soil resistance in the expressions for characteristic load (P_c) and characteristic moment (M_c). The undrained strength of clay (S_u), and the coefficient of passive earth pressure for sand (K_p) in those expressions were multiplied by F_m , leading to the following expressions for P_c and M_c .

For clay

$$P_c = 7.34D^2(E_p R_I) \left(\frac{S_u F_m}{E_p R_I} \right)^{0.68} \quad (1)$$

$$M_c = 3.86D^2(E_p R_I) \left(\frac{S_u F_m}{E_p R_I} \right)^{0.46} \quad (2)$$

For sand

$$P_c = 1.57D^2(E_p R_I) \left(\frac{\gamma' D \phi' K_p F_m}{E_p R_I} \right)^{0.57} \quad (3)$$

$$M_c = 1.33D^2(E_p R_I) \left(\frac{\gamma' D \phi' K_p F_m}{E_p R_I} \right)^{0.40} \quad (4)$$

where, P_c = characteristic load (force units, F), M_c = characteristic moment (force times length, FL), D = pile or shaft width or diameter (L), E_p = pile or drilled shaft modulus of elasticity (F/L^2), R_I = moment of inertia ratio (dimensionless), S_u = undrained shear strength for clay soil (F/L^2), F_m = pile or drilled shaft group efficiency based on pile spacing (dimensionless), γ' = effective unit weight for sand (F/L^3), ϕ' = effective stress friction angle of sand (degrees), K_p = Rankine coefficient of passive earth pressure of sand (dimensionless). Any consistent set of units may be used.

The value of R_I is the ratio of the moment of inertia of the pile to the moment of inertia of a solid circular section of the same width, or diameter.

Evans and Duncan Example

INPUT PARAMETERS	
UNITS	
FORCE =	KIPS
LENGTH =	IN
SOIL PROPERTIES	
ϕ =	36 DEGREES
γ =	6.94E-05 KIPS/IN ³
Kp =	3.85
PILE PROPERTIES	
Do =	12 IN
Di =	0 IN
I =	1728 IN ⁴
Rcr =	1
Ep =	4400 KIPS/IN ²
L =	720 IN
PILE GROUP PROPERTIES	
Nrow =	30
S/D =	1

- Given
 - 12" Square Concrete Pile
 - Restrained head
 - 60' long, 12" square
 - $f'_c = 6000$ psi
 - Shear load = 20 kips
 - Soil: Sand, $\phi' = 36$ deg., $\gamma = 120$ pcf
 - Groundwater table at depth of 40'
- Find
 - Lateral deflection of the pile top
 - Maximum moment at pile top

Evans and Duncan Example (Spreadsheet)

FIXED HEAD				
Pt	Pt/Pc	Yt/D	Yp	Mmax
KIPS			IN	IN-KIPS
per Pile				
10.0	0.0033	0.0054	0.065	317.0
20.0	0.0065	0.0152	0.183	780.5
30.0	0.0098	0.0280	0.336	1322.2
40.0	0.0131	0.0431	0.517	1921.9
50.0	0.0164	0.0603	0.723	2568.7
60.0	0.0196	0.0792	0.950	3255.7
70.0	0.0229	0.0998	1.198	3978.1
80.0	0.0262	0.1219	1.463	4732.2
90.0	0.0294	0.1455	1.746	5515.2
100.0	0.0327	0.1704	2.045	6324.8

Evans and Duncan Example (TAMWAVE)

- Answers are slightly different between the two because TAMWAVE uses a “default” value for concrete E which is different from the CLM2 spreadsheet
- Input required modification of default soil properties

Nominal Soil Unit Weight, lb/in ³	0.06944
Pile Moment of Inertia, in ⁴	1,728.00
Pile Section Modulus, in ³	288.00
Pile Solid Circle Moment of Inertia, in ⁴	1,017.88
Moment of Inertia Ratio R_i	1.698
Pile Moment of Inertia Ratio Product, ksi	8,488.3
Pile-Soil Interaction Variable	73,456
Pile L/D Ratio	60.0
Characteristic Load, lbs.	3,231,798.4
Characteristic Moment, in-lbs.	220,700,080.8
Pile Head Fixity	Fixed
Pile Head Lateral Load, lbs.	20,000.0
P_t/P_c	0.00619
Y_t/D	0.01402
Pile Head Deflection due to Load, inches	0.168
Maximum Moment Due to Pile Head Lateral Load, in-lbs	784,274.1
Maximum Bending Stress Due to Pile Head Lateral Load, in-lbs	2,723.2

Lateral Load Verification and Enhancement

Verification

- Full-scale lateral load tests
 - As with axial tests, slow and expensive, but the best way to determine lateral load capacity
 - Always a reaction test
 - Can be used to back calculate p-y curves
- Model lateral load tests
 - Conditions are controlled, but extrapolation is difficult
- Lateral Static Tests
 - Only used as an impact load test

Enhancement

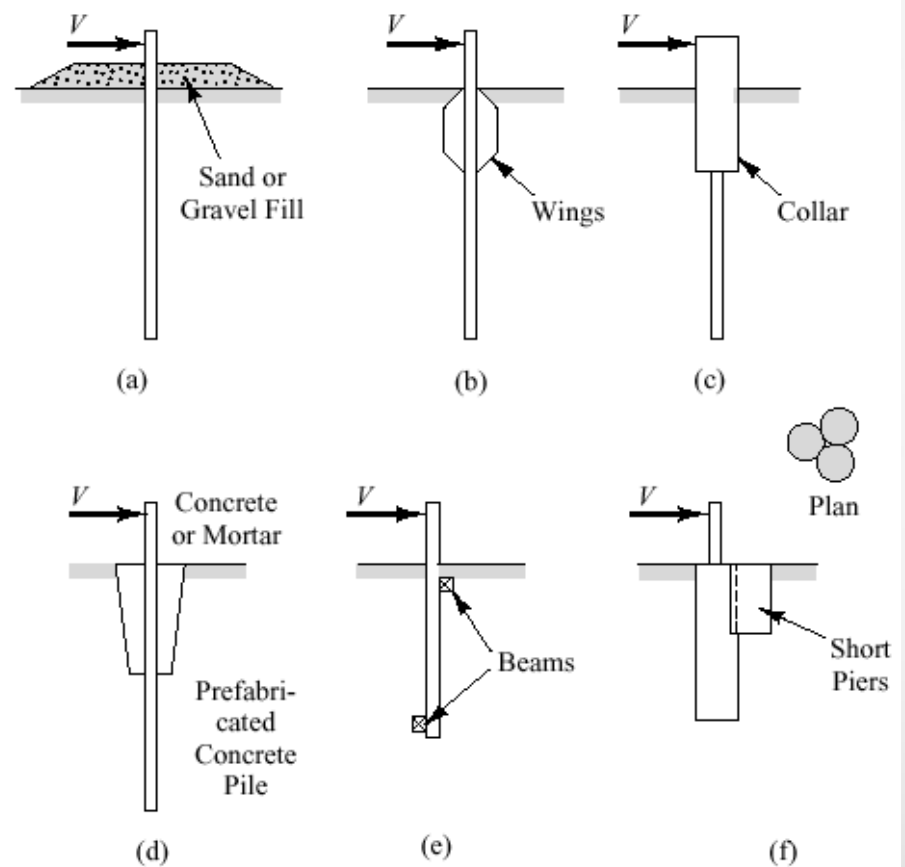

Questions

