

This document downloaded from
vulcanhammer.net vulcanhammer.info
Chet Aero Marine



Don't forget to visit our companion site
<http://www.vulcanhammer.org>

Use subject to the terms and conditions of the respective websites.

1. Report No. FHWA/TX-02/1874-1		2. Government Accession No.		3. Recipient's Catalog No.	
4. Title and Subtitle EVALUATION OF LABORATORY COMPACTION PROCEDURES FOR SPECIFICATION OF DENSITIES FOR COMPACTING FINE SANDS				5. Report Date JANUARY 2001	
7. Author(s) Brad J. Arcement and Stephen G. Wright				6. Performing Organization Code	
				8. Performing Organization Report No. Research Report 1874-1F	
9. Performing Organization Name and Address Center for Transportation Research The University of Texas at Austin 3208 Red River, Suite 200 Austin, TX 78705-2650				10. Work Unit No. (TRAIS)	
				11. Contract or Grant No. 0-1874	
12. Sponsoring Agency Name and Address Texas Department of Transportation Research and Technology Implementation Office P.O. Box 5080 Austin, TX 78763-5080				13. Type of Report and Period Covered Research Report (9/1999-7/2001)	
				14. Sponsoring Agency Code	
15. Supplementary Notes Project conducted in cooperation with the U.S. Department of Transportation, Federal Highway Administration, and the Texas Department of Transportation.					
16. Abstract <p>TxDOT utilizes a number of sources of cohesionless soils as fill materials for embankment construction and as backfill for mechanically stabilized earth (MSE) walls. Some problems have been experienced with these materials in the past, especially with settlements of backfills behind retaining walls. The objective of this project was to develop recommendations for compaction of cohesionless soils used as backfill materials. Emphasis was placed on uniform fine sands, which are used throughout a broad area of the State as fill materials.</p> <p>Fourteen cohesionless soils from around Texas were selected for laboratory testing. The majority of these soils were classified as uniform fine sands and silty sands. The selected soils were compacted using the following compaction procedures:</p> <ul style="list-style-type: none"> • TxDOT's Tx 113-E – Laboratory Compaction Characteristics and Moisture-Density Relationship of Base Materials • ASTM D 1557 – Laboratory Compaction Characteristics of Soil Using Modified Effort • British Standard BS-1377 – Vibrating Hammer Method • ASTM D 4253 – Maximum Index Density and Unit Weight of Soils Using a Vibratory Table <p>Based on the results of these tests as well as additional tests to measure the compressibility of the soil, recommendations were made for compaction.</p> <p>For uniform fine sands like those tested in this study it is recommended that they be compacted to 95 percent of the Modified proctor (ASTM D 1557) maximum dry unit weight for application where settlements are important to performance. It is also recommended that sufficient moisture be added to minimize settlements; compaction too dry can still result in excessive settlement even when the soil is compacted to the stated density. Alternative compaction recommendations are also presented based on TxDOT's Tx 113-E compaction procedure. However, this procedure is judged to be much more complex and less desirable than the ASTM D 1557 procedure.</p>					
17. Key Words Compaction, Soils, Embankment, Density			18. Distribution Statement No restrictions. This document is available to the public through the National Technical Information Service, Springfield, Virginia 22161.		
19. Security Classif. (of report) Unclassified		20. Security Classif. (of this page) Unclassified		21. No. of pages 174	22. Price

EVALUATION OF LABORATORY COMPACTION PROCEDURES FOR SPECIFICATION OF
DENSITIES FOR COMPACTING FINE SANDS

by

Brad J. Arcement
Stephen G. Wright

Research Report Number 1874-1

Research Project 0-1874

Assessment of Cohesionless Materials to be Used as Compacted Fill

Conducted for the

TEXAS DEPARTMENT OF TRANSPORTATION

in cooperation with the

U.S. DEPARTMENT OF TRANSPORTATION
Federal Highway Administration

by the

CENTER FOR TRANSPORTATION RESEARCH
Bureau of Engineering Research
THE UNIVERSITY OF TEXAS AT AUSTIN

January 2001

DISCLAIMERS

The contents of this report reflect the views of the authors, who are responsible for the facts and the accuracy of the data presented herein. The contents do not necessarily reflect the official views or policies of the Federal Highway Administration or the Texas Department of Transportation. This report does not constitute a standard, specification, or regulation.

There was no invention or discovery conceived or first actually reduced to practice in the course of or under this contract, including any art, method, process, machine, manufacture, design or composition of matter, or any new and useful improvement thereof, or any variety of plant, which is or may be patentable under the patent laws of the United States of America or any foreign country.

NOT INTENDED FOR CONSTRUCTION, BIDDING, OR PERMIT PURPOSES

Stephen G. Wright, P.E. (Texas No. 49007)
Research Supervisor

ACKNOWLEDGMENTS

Research performed in cooperation with the Texas Department of Transportation and the U.S. Department of Transportation, Federal Highway Administration.

TABLE OF CONTENTS

LIST OF TABLES	viii
LIST OF FIGURES	x
CHAPTER 1 INTRODUCTION	1
1.1 BACKGROUND	1
1.2 GOALS AND OBJECTIVES	2
1.3 ORGANIZATION OF REPORT	3
CHAPTER 2 SOILS TESTED	5
2.1 INTRODUCTION	5
2.2 SOILS TESTED	5
2.2.1 Grain Size Distributions	6
2.2.2 Poorly Graded Sands (SP)	8
2.2.3 Poorly Graded Sands with Silt (SP-SM)	8
2.2.4 Silty Sands (SM)	11
2.2.5 Summary of Soils Tested	11
2.3 SOILS TESTED IN THE TTI STUDY	11
2.4 SUMMARY OF SOILS TESTED	14
CHAPTER 3 TEST PROCEDURES USED	17
3.1 INTRODUCTION	17
3.2 MODIFIED PROCTOR COMPACTION TEST (ASTM D-1557)	17
3.3 TXDOT COMPACTION TEST (TX-113-E)	21
3.4 MAXIMUM AND MINIMUM INDEX DENSITY (ASTM D-4254 AND ASTM D-4253)	22
3.4.1 Minimum Index Density (ASTM D-4254)	22
3.4.2 MAXIMUM INDEX DENSITY (ASTM D-4253)	27
3.5 BRITISH VIBRATORY HAMMER (BS-1377)	30
3.6 SUMMARY OF TEST PROCEDURES USED	31
CHAPTER 4 COMPACTION TEST RESULTS FOR THE MODIFIED PROCTOR COMPACTION PROCEDURE	35
4.1 INTRODUCTION	35
4.2 MOISTURE-DENSITY CURVES	35
4.3 PARTICLE BREAKDOWN	41
CHAPTER 5 COMPACTION TEST RESULTS FOR THE TXDOT COMPACTION PROCEDURE	43
5.1 INTRODUCTION	43
5.2 MOISTURE-DENSITY CURVES	43
5.3 PARTICLE BREAKDOWN	48
CHAPTER 6 TEST RESULTS USING THE ASTM MAXIMUM AND MINIMUM INDEX DENSITY PROCEDURES	51
6.1 INTRODUCTION	51
6.2 TEST RESULTS	51
6.3 DETERMINATION OF RELATIVE DENSITIES	54
CHAPTER 7 COMPACTION TEST RESULTS USING THE BRITISH STANDARD COMPACTION PROCEDURE WITH A VIBRATORY HAMMER	55
7.1 INTRODUCTION	55
7.2 MOISTURE-DENSITY CURVES	55
7.3 SUMMARY OF BRITISH VIBRATORY HAMMER COMPACTION TESTS	60

CHAPTER 8 COMPARISON OF TEST RESULTS.....	61
8.1 INTRODUCTION	61
8.2 MAXIMUM DRY DENSITY	61
8.2.1 Comparisons of Results of Modified Proctor, TxDOT, and Maximum Index Density Tests	61
8.2.1.1 Comparison between Results of Modified Proctor and Maximum Index Density Tests	64
8.2.1.2 Comparison between Results of TxDOT and Maximum Index Density Tests	64
8.2.2 Comparison between Results of TxDOT and Modified Proctor Tests	69
8.2.3 Comparison of Results of British Vibratory Hammer Test with Maximum Index Density, Modified Proctor, and TxDOT Tests	69
8.2.3.1 Comparison between Results of British Vibratory Hammer and Maximum Index Density Tests	72
8.2.3.2 Comparison Between Results of British Vibratory Hammer and Modified Proctor Tests	72
8.2.3.3 Comparison between Results of British Vibratory Hammer and TxDOT Tests	78
8.2.4 Factors that Influence the Compaction Test Results.....	78
8.2.4.1 Compactive Effort of Impact Compaction Procedures	80
8.2.4.2 Compactive Effort of Vibratory Compaction Procedures.....	80
8.2.4.3 Effects of Surcharge Load on Vibratory Test Results.....	82
8.2.4.4 Other Factors That Affect the Maximum Density for Vibratory Methods.....	82
8.2.4.5 Effect of Soil Type on Differences between Vibratory and Impact Type Compacted Densities	84
8.2.4.6 Summary of Factors That Influence the Compaction Test Results	84
8.3 GENERAL CHARACTERISTICS OF THE MOISTURE-DENSITY CURVES.....	85
8.4 OPTIMUM MOISTURE CONTENTS	87
8.5 VARIATIONS OF DENSITY IN MODIFIED PROCTOR COMPACTION TESTS.....	91
8.5.1 Split-Mold Compaction Test Equipment and Procedure	91
8.5.2 Modified Proctor Test Results for Special Split-Mold	93
8.5.3 Discussion of Results of Special Modified Proctor Tests with Split Mold	93
8.6 PARTICLE BREAKAGE.....	98
8.7 INFLUENCE OF SOIL GRADATION ON MOISTURE-DENSITY RELATIONSHIPS	103
8.7.1 Influence of C_u and C_c	103
8.7.2 Influence of Percent Fines	108
8.7.3 Influence of Percentage of Fine Sand	108
8.7.4 Summary of Correlation between Soil Gradation and Moisture- Density Relationships from Various Compaction Tests.....	119
8.8 COMPARISON WITH FINDINGS OF TTI STUDY.....	119
8.9 SUMMARY OF ANALYSIS OF COMPACTION TEST RESULTS	123
CHAPTER 9 EVALUATION OF COMPACTION TEST PROCEDURES AND RECOMMENDATIONS FOR COMPACTION SPECIFICATIONS	125
9.1 INTRODUCTION	125
9.2 CURRENT TXDOT COMPACTION SPECIFICATIONS FOR COHESIONLESS SANDS	125
9.2.1 Material Specifications for Embankments	126

9.2.2	Material Specifications for MSE Backfill.....	126
9.2.3	Specified Laboratory Compaction Test for Cohesionless Soils.....	127
9.2.4	Current TxDOT Compaction Control Standards for Cohesionless Soils.....	128
9.3	ALTERNATIVE COMPACTION CONTROL STANDARDS.....	128
9.4	RECOMMENDATIONS FOR COMPACTION SPECIFICATIONS.....	130
9.4.1	Recommendations for Modified Proctor Test.....	130
9.4.2	Recommendations for TxDOT Test.....	131
9.5	OBSERVATION OF FIELD PROBLEMS AND SUPPLEMENTAL RECOMMENDATIONS.....	134
9.5.1	Recommendations for Field Moisture-Density Measurements.....	134
9.5.2	Recommendations for Moisture Control.....	135
9.5.3	Recommendations for Compaction Equipment for MSE Backfill.....	135
CHAPTER 10	SUMMARY.....	137
10.1	DESCRIPTION OF RESEARCH.....	137
10.2	LABORATORY FINDINGS.....	137
10.3	RECOMMENDATIONS.....	138
APPENDIX A	GRAIN SIZE DISTRIBUTION CURVES.....	141
REFERENCES	157

LIST OF TABLES

Table 2.1:	Listing of soils received for testing and corresponding TxDOT Districts.....	6
Table 2.2:	Description and USCS Classification of Soils Tested.....	7
Table 2.3:	Percent Passing No. 200 sieve, coefficient of uniformity (C_u), coefficient of curvature (C_c), and USCS Classification of soils tested.....	15
Table 2.4:	Comparison of soils tested on this project with the soils tested by Delphia(1998).....	16
Table 3.1:	Reference and standard designation for each test procedure used	18
Table 3.2:	Maximum dry densities determined by the Wet Method and Dry Method according to ASTM D-4253 for selected SP, SP-SM, and SM soils	30
Table 4.1:	Maximum dry density and optimum moisture content from Modified Proctor (ASTM D-1557) compaction tests.....	36
Table 4.2:	Results of modified Proctor compaction test performed at identical moisture contents	40
Table 4.3:	Change in Percent Passing No. 200 Sieve by Modified Proctor (ASTM D-1557) compaction tests.....	42
Table 5.1:	Maximum dry density and optimum moisture content from TxDOT Proctor (Tx-113-E) compaction tests.....	44
Table 5.2:	Change in Percent Passing No. 200 Sieve by Tx-113-E Proctor compaction tests.....	49
Table 6.1:	Minimum dry density from the Minimum Index Density Procedure (ASTM D-4254)	52
Table 6.2:	Maximum dry density from Maximum Index Density Procedure (ASTM D-4253)	53
Table 7.1:	Maximum dry density and optimum moisture content from British Vibratory Hammer (BS-1337) compaction tests	56
Table 8.1:	Maximum dry density from Maximum Index Density (ASTM D-4253), Modified Proctor (ASTM D-1557), and TxDOT (Tx-113-E) procedures.....	62
Table 8.2:	Maximum dry density from Maximum Index Density (ASTM D-4253), Modified Proctor (ASTM D-1557), TxDOT (Tx-113-E) procedures, and the British Vibratory Hammer (BS-1337) procedures	63
Table 8.3:	Difference between maximum dry density from Modified Proctor (ASTM D-1557) and Maximum Index Density (ASTM D-4253) tests	65
Table 8.4:	Difference in maximum dry density between TxDOT (Tx-113-E) and Maximum Index Density (ASTM D-4253) tests.....	67
Table 8.5:	Difference between maximum dry density from TxDOT (Tx-113-E) and Modified Proctor (ASTM D-1557) tests.....	70
Table 8.6:	Difference between maximum dry density from British Vibratory Hammer (BS-1377) and Maximum Index Density (ASTM D-4253) tests	73
Table 8.7:	Difference between maximum dry density from British Vibratory Hammer (BS-1377) and Modified Proctor (ASTM D-1557) tests	77
Table 8.8:	Difference between maximum dry density from British Vibratory Hammer (BS-1377) and TxDOT (Tx-113-E) tests.....	79
Table 8.9:	Input variables and compactive effort of impact type compaction tests.....	81
Table 8.10:	Input variables and compactive effort of vibratory type compaction tests.....	83
Table 8.11:	Optimum moisture content (%) from Modified Proctor (ASTM D-1557) and TxDOT (Tx-113-E) procedures.....	88
Table 8.12:	Optimum moisture content (%) from Modified Proctor (ASTM D-1557), TxDOT (Tx-113-E), and British Vibratory Hammer (BS-1377).....	89
Table 8.13:	Maximum dry density from special split-mold Modified Proctor compaction tests.....	97
Table 8.14:	Optimum moisture content from special split-mold Modified Proctor compaction tests.....	97

Table 8.15:	Comparison of the maximum dry densities from the special split-mold Modified Proctor procedure with the maximum dry densities obtained by the Maximum Index Density Procedure.....	99
Table 8.16:	Percent passing the No. 200 sieve before and after Modified Proctor and TxDOT compaction tests	100
Table 8.17:	Average increase in Percent passing the No. 200 sieve after Modified Proctor and TxDOT compaction tests	102
Table 9.1:	Gradation limitations specified by TxDOT for Type A and Type B backfill behind MSE retaining structures	126
Table 9.2:	Average percent of maximum dry density from the TxDOT procedure that is equivalent to 95 percent of the maximum density from the Modified Proctor procedure.....	132

LIST OF FIGURES

Figure 2.1:	Poorly graded sands (SP).....	9
Figure 2.2:	Poorly graded sands with silt (SP-SM)	10
Figure 2.3:	Poorly graded silty sand (SM)	12
Figure 2.4:	Grain size envelope of all tested soils.....	13
Figure 3.1:	Cylindrical mold and manual drop hammer typically utilized for Standard and Modified Proctor compaction tests	19
Figure 3.2:	Mechanical rammer used for Modified Proctor (ASTM D-1557) Compaction tests.....	20
Figure 3.3:	Double-faced 10 lb hammer and neoprene pad used for TxDOT compaction tests.....	23
Figure 3.4:	TxDOT mechanical rammer used for TxDOT compaction tests	24
Figure 3.5:	Apparatus for measuring height of sample for TxDOT compaction tests	25
Figure 3.6:	Pouring device for Minimum Index Density test	27
Figure 3.7:	Vibratory table for Maximum Index Density (ASTM D-4253) test.....	29
Figure 3.8:	British Vibratory Hammer	32
Figure 3.9:	British Vibratory Hammer with frame and lever arm.....	33
Figure 4.1:	Moisture-density curve of poorly graded sands (SP) from modified Proctor compaction (ASTM D-1557).....	37
Figure 4.2:	Moisture-density curve of poorly graded sand with silt (SP-SM) from Modified Proctor compaction (ASTM D-1557)	38
Figure 4.3:	Moisture-density curve of poorly graded silty sand (SM) from Modified Proctor compaction (ASTM D-1557)	39
Figure 5.1:	Moisture-density curve of poorly graded sands (SP) from Tx-113-E compaction.....	45
Figure 5.2:	Moisture density curve of poorly graded sand with silt (SP-SM) from Tx-113-E compaction	46
Figure 5.3:	Moisture density curve of poorly graded silty sand (SM) from Tx-113-E compaction	47
Figure 7.1:	Moisture density curve of poorly graded sand with silt (SP) from BS-1337 compaction.....	57
Figure 7.2:	Moisture density curve of poorly graded sand with silt (SP-SM) from BS-1337 compaction.....	58
Figure 7.3:	Moisture density curve of poorly graded silty sand (SM) from BS-1337 compaction.....	59
Figure 8.1:	Comparison of maximum dry density from Modified Proctor (ASTM D-1557) and Maximum Index Density (ASTM D-4253) procedures.....	66
Figure 8.2:	Comparison of maximum dry densities from TxDOT (Tx-113-E) and Maximum Index Density (ASTM D-4253) procedures	68
Figure 8.3:	Comparison of maximum dry density from TxDOT (Tx-113-E) and Modified Proctor (ASTM D-1557) procedures	71
Figure 8.4:	Comparison of maximum dry density from British Vibratory Hammer (BS-1377) to Maximum Index Density (ASTM D-4253).....	74
Figure 8.5:	Comparison of maximum dry density from British Vibratory Hammer (BS-1377) to Modified Proctor (ASTM D-1577)	75
Figure 8.6:	Comparison of maximum dry density from British Vibratory Hammer (BS-1377) to TxDOT (Tx-113-E) procedures	76
Figure 8.7:	Idealized moisture-density curve for clean sands.....	86
Figure 8.8:	Comparison of Optimum Moisture Content (%) from Modified Proctor Procedure and TxDOT Procedure.....	90
Figure 8.9:	Fully assembled special 4-inch diameter split-mold	92

Figure 8.10:	Moisture density curve of Beaumont soil (SP) from special split-Mold Modified Proctor tests.....	94
Figure 8.11:	Moisture density curve of Houston soil (SP-SM) from special split-mold Modified Proctor tests.....	95
Figure 8.12:	Moisture density curve of NWTLE soil (SM) from special split-Mold Modified Proctor tests.....	96
Figure 8.13:	Percent Fines (Passing No. 200 Sieve) Before and After Modified Proctor and TxDOT Comparison Tests	101
Figure 8.14:	Comparison of C_u and C_c with the maximum dry densities from the Maximum Index Density procedure	104
Figure 8.15:	Comparison of C_u and C_c with the maximum dry densities from the Modified Proctor procedure	105
Figure 8.16:	Comparison of C_u and C_c with the maximum dry densities from the TxDOT procedure	106
Figure 8.17:	Comparison of C_u and C_c with the maximum dry densities from the British Vibratory Hammer procedure	107
Figure 8.18:	Percent Fines (Passing No. 200 Sieve) of All Soils Tested.....	109
Figure 8.19:	Relationship between Maximum Dry Density determined by ASTM D-4253 Maximum Index Density Procedure and the Percent Passing the No. 200 Sieve.....	110
Figure 8.20:	Relationship between Maximum Dry Density determined by ASTM D-1557 Modified Proctor Test Procedure and the Percent Passing the No. 200 Sieve.....	111
Figure 8.21:	Relationship between Maximum Dry Density determined by TxDOT Tx-113E Test Procedure and the Percent Passing the No. 200 Sieve	112
Figure 8.22:	Relationship between Maximum Dry Density determined by BS-1377 British Vibratory Hammer Test Procedure and the Percent Passing the No. 200 Sieve.....	113
Figure 8.23:	Percent Fine Sand (No. 40 Sieve to No. 200 Sieve).....	114
Figure 8.24:	Relationship between Maximum Dry Density determined by ASTM D-4253 Maximum Index Density Procedure and the Percent Fine Sand (No. 40 — No. 200 Sieve Sizes).....	115
Figure 8.25:	Relationship between Maximum Dry Density determined by ASTM D-1557 Modified Proctor Test Procedure and the Percent Fine Sand (No. 40 — No. 200 Sieve Sizes).....	116
Figure 8.26:	Relationship between Maximum Dry Density determined by TxDOT Tx-113E Test Procedure and the Percent Fine Sand (No. 40 — No. 200 Sieve Sizes).....	117
Figure 8.27:	Relationship between Maximum Dry Density determined by BS-1377 British Vibratory Hammer Test Procedure and the Percent Fine Sand (No. 40 — No. 200 Sieve Sizes).....	118
Figure 8.28:	Relationship between Maximum Dry Density from Modified Proctor Procedure and Coefficient of Uniformity (C_u) from Delphia (1998) Study and This Study	121
Figure 8.29:	Relationship between Maximum Dry Density from British from TTI Study and This Study	122
Figure 9.1:	Relationship between 92 Percent of TxDOT TX-113E Maximum Dry Density and 95 Percent of Modified Proctor (ASTM D-1557) Maximum Dry Density	133

CHAPTER ONE

INTRODUCTION

1.1 BACKGROUND

Sands are typically utilized as backfill behind earth-retaining structures throughout Texas. Sands are also used to construct embankments, primarily in the western half of the state. The sands used are usually strong and water drains freely from them relative to finer-grained soils. However, successful use of these soils requires proper placement and compaction to ensure adequate performance. Compaction increases the strength and decreases the compressibility of the soil. Poor compaction of cohesionless backfill causes lower strengths and significant settlement of the backfill that may lead to distress of the structure.

The Texas Department of Transportation (TxDOT) has experienced problems with the use of cohesionless backfill attributed to improper compaction. During construction, field measurements of the backfill are performed to determine the dry density of the compacted soil. The field dry density is typically required to be some percentage of the maximum dry density obtained by a specified laboratory test. For “cohesionless” soils, TxDOT specifications require a special laboratory compaction test (Tx-113-E) to determine the maximum dry density.

TxDOT is the only department of transportation that uses the Tx-113-E compaction test procedure to determine the maximum dry density of cohesionless soils (Christensen 1999). The most common laboratory tests used to determine maximum dry density are the Standard and Modified Proctor tests, ASTM D-698 and ASTM D-1557, respectively. The Tx-113-E procedure is similar in principle to the ASTM standard tests, but with several uncommon modifications. These modifications do not appear to be completely understood and may not always be implemented properly.

Most geotechnical engineers generally accept that relative density is the best measure of density or degree of compaction for cohesionless soils (Lambe and Whitman 1969; Das 1994). Relative density is based on the ASTM D-4253 and D-4254 standard tests to determine maximum and minimum dry densities, respectively. The maximum density is

determined using a special vibratory table. A review of specifications of forty-five state and federal highway agencies, however, indicated that relative density is not used by any of these agencies to measure and control the density of cohesionless soils (Christensen 1999). Thus, while conventionally accepted as the best measure of density, relative density is seldom, if ever, used in practice. Relative density is generally not used because of the high cost and common maintenance problems associated with the equipment specified by the ASTM standard.

Concerns have been expressed about whether the current TxDOT compaction specifications result in realistic or adequate compaction of cohesionless backfill. There is at least anecdotal information that suggests compaction problems have occurred on TxDOT projects, especially for compaction of cohesionless backfill behind retaining walls. Comparison of the Tx-113-E procedure with other compaction procedures is needed to determine the best test procedure for controlling the compaction of cohesionless soils in Texas.

1.2 GOALS AND OBJECTIVES

The goal of the research described in the following chapters was to determine an appropriate compaction procedure and specifications for TxDOT to use in controlling the compaction of cohesionless backfill. Several standardized compaction procedures were investigated: Modified Proctor (ASTM D-1557), Maximum and Minimum Index Density (ASTM D-4253 and ASTM D-4254, respectively), TxDOT (Tx-113-E), and British Vibratory Hammer (British Standard BS-1377). These are each described in Chapter 3. Compaction tests were performed on fourteen soils from several regions of Texas. These soils consisted of three different soil types as characterized by the Unified Soil Classification System (USCS): poorly graded sand (SP), poorly graded sand with silt (SP-SM), and poorly graded silty sand (SM).

The primary objective of the research presented in this report was to determine and evaluate maximum densities and moisture-density relationships obtained by the various compaction procedures. A second objective was to evaluate the breakage of particles that occurred during the compaction tests. Significant particle breakage may modify the gradation

of a soil enough to change its index properties and classification. Such changes may alter the compaction characteristics of the soil.

Prior to the current study, another study was performed by Delphia (1998) for the Texas Transportation Institute (TTI) at Texas A&M University to determine the factors that affect the compaction of cohesionless sands. That study involved compaction using the Standard Proctor (ASTM D-698), Modified Proctor (ASTM D-1557), and British Vibratory Hammer (BS-1377) compaction procedures. One objective of the current study was to compare the findings of the TTI study with the current research.

1.3 ORGANIZATION OF REPORT

The description and index properties of the fourteen soils tested for the current project are presented in Chapter 2. The laboratory compaction procedures investigated and used are discussed in Chapter 3. Results of compaction tests using the various compaction procedures are presented in Chapters 4 through 7. The test results from the Modified Proctor compaction procedure are presented in Chapter 4. Results include the moisture-density curves and data on particle breakage. Similar results for the TxDOT compaction test are presented in Chapter 5. The results from the Maximum and Minimum Index Density tests for relative density calculations are detailed in Chapter 6. Moisture-density curves from the British Vibratory Hammer compaction test are presented in Chapter 7. In Chapter 8 results of the various compaction tests are compared. Chapter 8 also includes a comparison with the findings of the study by Delphia. In Chapter 9, the current TxDOT compaction specifications are reviewed and the compaction specifications recommended from this study are presented. Several important compaction issues not within the scope of this study were observed during the compaction of a cohesionless backfill behind a retaining wall in Austin, Texas. The importance of these compaction issues for adequate compaction of cohesionless backfill is discussed in Chapter 9. A summary and recommendations are presented in Chapter 10.

CHAPTER TWO

SOILS TESTED

2.1 INTRODUCTION

Several soils from a number of different locations in Texas were tested for this project. Identification of the soils to be tested was done in close cooperation with the Texas Department of Transportation (TxDOT) personnel. At the outset of this project, a field survey of borrow pits and material sources in the El Paso area was conducted. From this survey several candidate soils were identified and samples of approximately nine soils were obtained for testing. Additional soils were identified in five other TxDOT districts located in Beaumont, Austin, Houston, Ft. Worth, and Corpus Christi. One soil from each of these districts was selected and received for testing. A list of the soils obtained from each district, including the names assigned to identify each soil, is presented in Table 2.1. Attempts were made to perform tests on some of the same soils tested in the previous study by Delphia (1998); unfortunately, the same materials could not be obtained. However, the soils tested in this project represent soils utilized on a regular basis in Texas.

Grain size distributions and classifications, according to the Unified Soil Classification System (USCS), were determined for all fourteen soils tested. Grain size distributions were determined by sieve analyses in accordance with ASTM D-422-90 (ASTM 1998). Soil retained on the No. 200 sieve was washed to determine the percent passing the No. 200 sieve.

2.2 SOILS TESTED

The soils tested represent a range of naturally occurring cohesionless soils from throughout Texas. Only the soil from Ft. Worth was plant-blended. The variety of soils was chosen to investigate how each of the various compaction tests performed for a limited range of soils commonly used as cohesionless backfill by TxDOT. The range of soils tested was focused on problematic cohesionless soils that were considered difficult to compact by TxDOT personnel.

Table 2.1: Listing of soils received for testing and corresponding TxDOT districts

Soil	District
Plant #9	El Paso
McNary	El Paso
Northwest No Aggregate (NW No Ag.)	El Paso
Ft. Worth	Ft. Worth
Corpus Christi	Corpus Christi
Beaumont	Beaumont
Austin	Austin
Houston	Houston
Redd Road	El Paso
Horizon	El Paso
Northwest with Aggregate (NW w/Ag.)	El Paso
Acala	El Paso
Northwest Top Lift East (NWTLE)	El Paso
MP 53	El Paso

2.2.1 Grain Size Distributions

The grain size distribution curves for the soils prior to compaction are presented in Appendix A as the “initial” grain size curves for the fourteen soils tested. Grain size distribution curves for the soils after each impact compaction test are also presented in Appendix A and discussed further in later chapters. Each of the soils was classified in accordance with the USCS. A description of each soil tested and the USCS classification symbol are presented in Table 2.2.

The soils tested are classified into one of the following three groups according to the USCS classification: poorly graded sand (SP), poorly graded sand with silt (SPSM), and poorly graded silty sand (SM). No well-graded sands (SW) were tested. In nature, relatively

Table 2.2: Description and USCS Classification of Soils Tested

Soil	Description	Classification
Plant #9	Poorly graded uniform fine sand	SP
McNary	Poorly graded uniform fine sand	SP
Northwest No Aggregate (NW No Ag.)	Poorly graded uniform fine sand	SP
Ft. Worth	Poorly graded sand with gravel	SP
Corpus Christi	Poorly graded coarse sand	SP
Beaumont	Poorly graded uniform fine sand	SP
Austin	Poorly graded fine sand with silt	SP-SM
Houston	Poorly graded fine sand with silt	SP-SM
Redd Road	Poorly graded fine sand with silt	SP-SM
Horizon	Poorly graded fine sand with silt	SP-SM
Northwest with Aggregate (NW w/Ag.)	Poorly graded fine sand with silt	SP-SM
Acala	Poorly graded sand with silt	SP-SM
Northwest Top Lift East (NWTLE)	Poorly graded silty sand	SM
MP 53	Poorly graded silty sand with caliche	SM

few well-graded sand deposits exist. Sand is typically formed by the mechanical and chemical weathering of rock and transported by wind or water. The size of a sand particle that can be moved by wind or water is proportional to the velocity of the wind or water. Different-sized particles tend to be deposited at geographical locations where the speed of transport has changed. Consequently, natural sand deposits are commonly uniform in size and not well graded (Scott 1980).

2.2.2 Poorly Graded Sands (SP)

Poorly graded sands (SP) represent the cohesionless backfill most widely used by TxDOT. Six of the sands tested from four different TxDOT districts were classified as poorly graded sands (SP). The grain size distribution curves for the six soils classified as poorly graded sands are presented in Figure 2.1. The three soils from El Paso were very similar, consisting of poorly graded uniform fine sands. The soil from Beaumont was poorly graded, uniform, fine “beach” sand. In spite of its SP classification, the soil from Ft. Worth was actually fairly well-graded soil despite its classification. The Ft. Worth soil was a plant-mixed material with a significant amount of gravel. The soil from Corpus Christi consisted of uniform coarse sand that bears more visual resemblance to “pea gravel” than what is typically perceived as sand.

2.2.3 Poorly Graded Sands with Silt (SP-SM)

Six of the soils tested were classified as poorly graded sands with silt (SP-SM). The grain size distribution curves of the six soils classified as SP-SM are presented in Figure 2.2. The principal difference between the soils classified as SP soils and the soils classified as SP-SM soils is the amount of fine-grained particles i.e., the percent by weight passing the No. 200 sieve. The SP sands all had less than 5 percent passing the No. 200 sieve, while the SP-SM materials had between 5 and 12 percent passing. The majority of the fine particles in the five SP-SM soils consisted of nonplastic silt particles with small traces of clay and low-plasticity silt.

Figure 2.1: Poorly graded sands (SP)

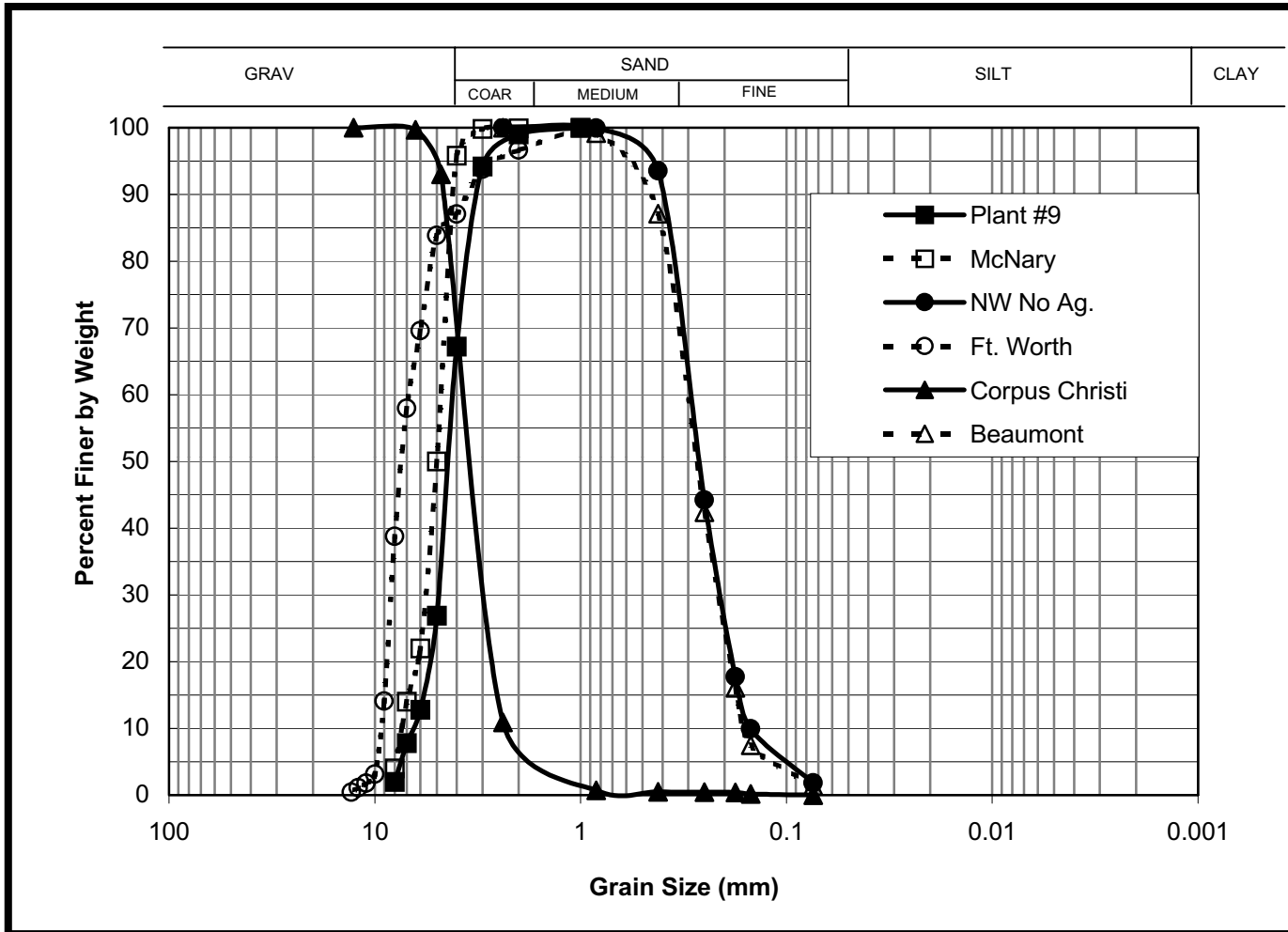
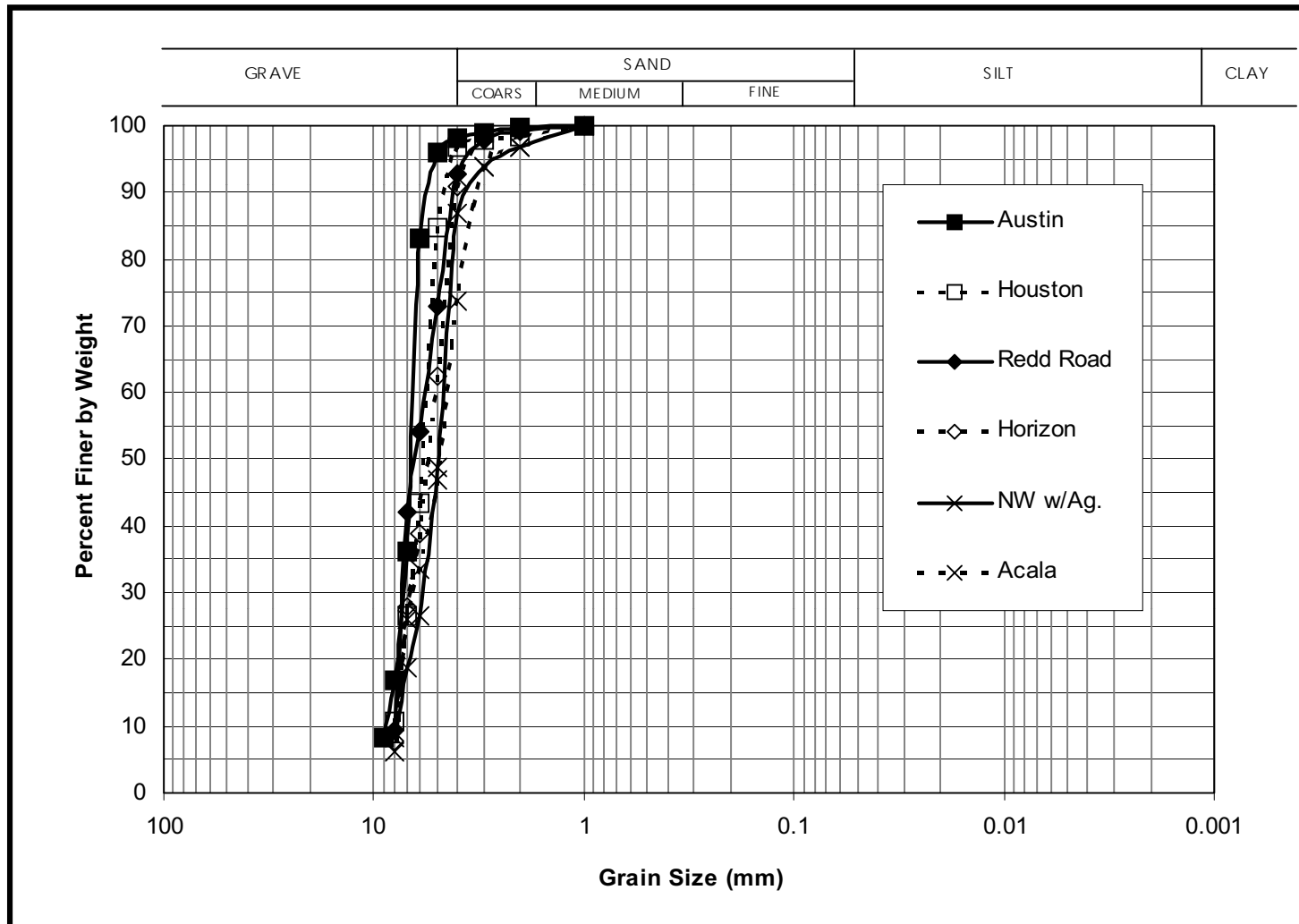

Figure 2.2: Poorly graded sands with silt (SP-SM)



2.2.4 Silty Sands (SM)

Two of the soils tested were classified as poorly graded silty sands (SM). Both of these soils were from the El Paso District of TxDOT. The grain size curves for these two soils are presented in Figure 2.3. The two sands had about 25 percent by weight passing the No. 200 sieve. The majority of the fine particles in the SM soils consisted of nonplastic silt particles with small traces of clay and low-plasticity silt. The soil referred to as NWTLE consisted entirely of poorly graded silty sand, while the soil referred to as MP 53 contained a significant amount of sand-sized caliche particles. Caliche is a material in which the particle grains are cemented by carbonate deposits (Peck et al. 1974). The carbonate is deposited into the soil by evaporation in semiarid climates such as El Paso.

2.2.5 Summary of Soils Tested

An envelope of grain sizes representing the range for all the soils tested in this study is presented in Figure 2.4. The percent passing the No. 200 sieve, Uniformity Coefficient (C_u), and Coefficient of curvature (C_c) of each soil are summarized in Table 2.3. The relationships between these soil properties and the results from the compaction tests described and presented in Chapters 3 through 7 are examined in Chapter 8.

2.3 SOILS TESTED IN THE TTI STUDY

Delphia (1998) tested and reported data for a total of sixty-two cohesionless sands of mostly unknown geologic origin. Fifty-seven of these sands were classified as SP soils; the remaining five were classified as SW soils. The SP soils consisted of thirty-five medium sands and fine sands. The SW soils consisted of a single coarse sand and four medium sands. The percent by weight passing the No. 200 sieve, coefficient of uniformity (C_u), and coefficient of curvature (C_c) from the soils tested in this study and the study by Delphia (1998) are shown in Table 2.4 for comparison. Delphia tested SP soils with a wider range of uniformity coefficients (C_u) than the soils tested in this study. He also included SW soils, which were not tested in the current study. Delphia's study was limited to materials that had

Figure 2.3: Poorly graded silty sand (SM)

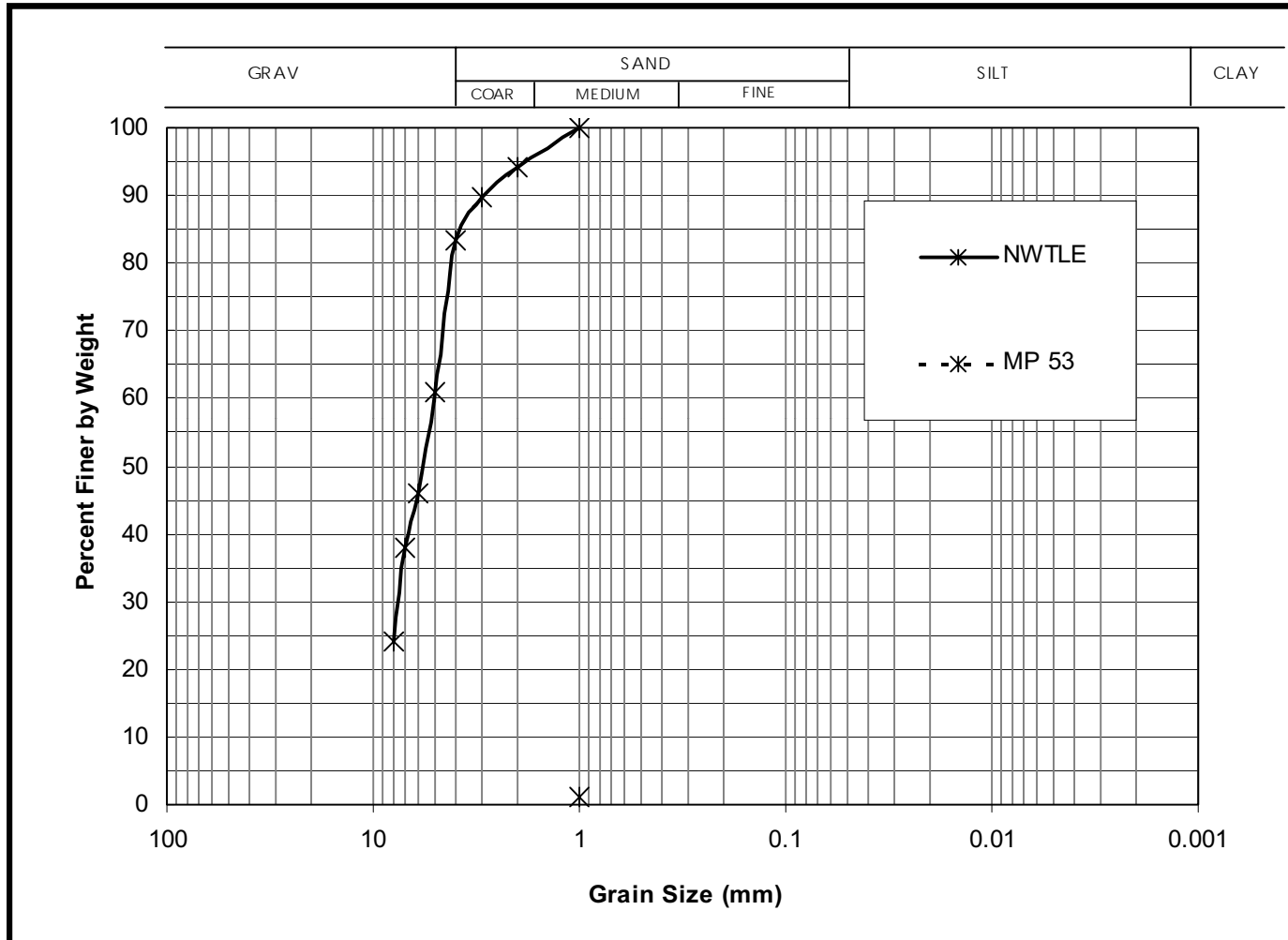
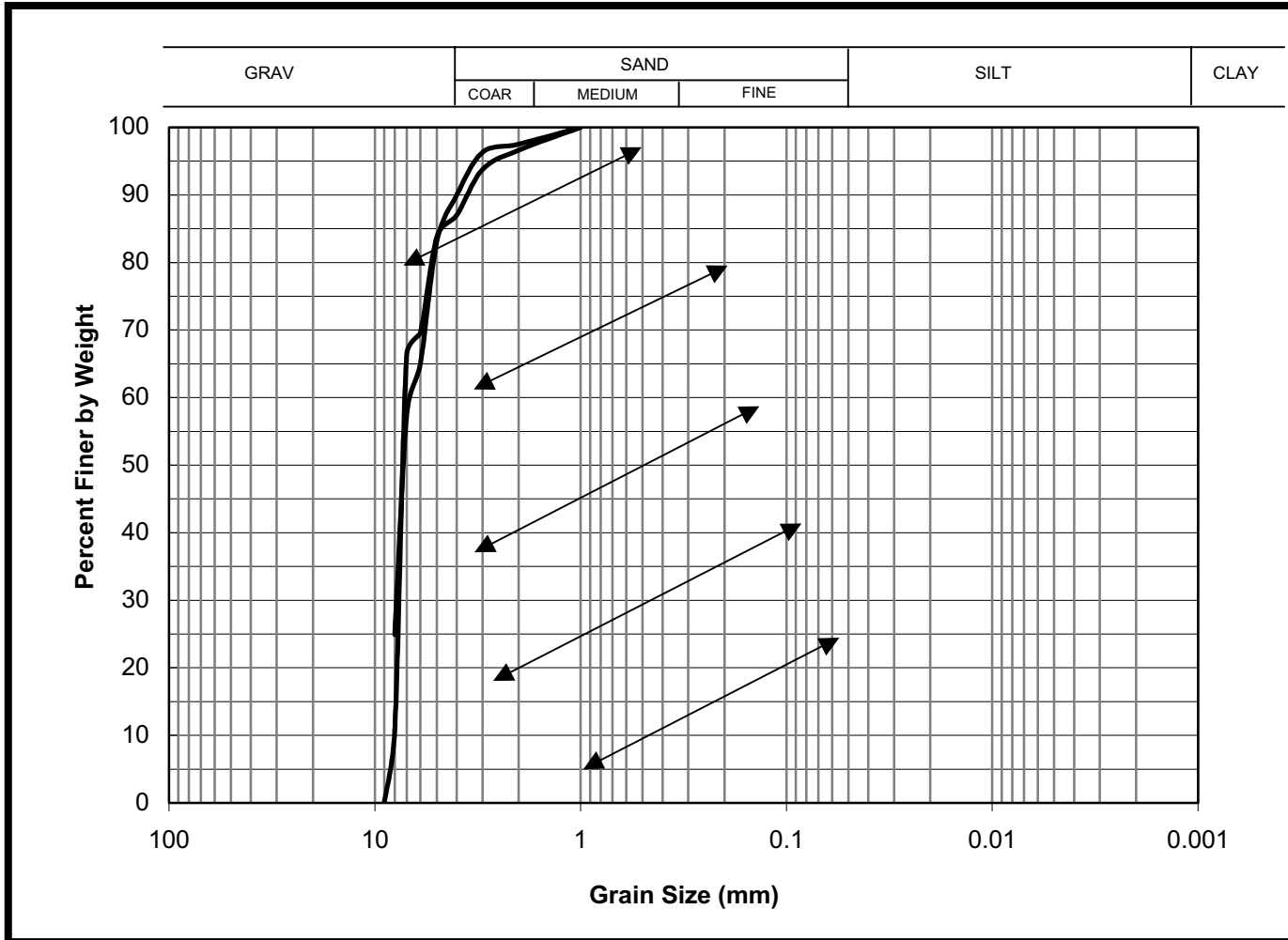

Figure 2.4: Grain size envelope of all tested soils



less than five percent by weight passing the No. 200 sieve; therefore, no SP-SM or SM soils were tested. Delphia developed relationships between maximum dry density and optimum moisture content with C_u and C_c for the sixty-two soils that he tested using various compaction tests. The applicability of the relationships developed by Delphia for the SP-SM and SM soils tested in this current study is evaluated in Chapter 8.

2.4 SUMMARY OF SOILS TESTED

Compaction tests were performed on the fourteen soils described in this chapter. These tests were performed using the standard compaction procedures described in Chapter 3. Results of these compaction tests are presented in Chapters 4 through 7.

Table 2.3: Percent Passing No. 200 sieve, coefficient of uniformity (C_u), coefficient of curvature (C_c), and USCS Classification of soils tested

Soil Properties				
Soil	Percent Passing No. 200 Sieve	Coefficient of Uniformity (C_u)	Coefficient of Curvature (C_c)	Classification
Plant #9	2.0	2.2	1.0	SP
McNary	4.0	2.3	1.2	SP
NW No Ag.	1.8	1.9	1.0	SP
Ft. Worth	0.4	7.2	0.4	SP
Corpus Christi	0.2	1.5	1.0	SP
Beaumont	1.4	1.8	1.0	SP
Austin	8.4	2.4	1.3	SP-SM
Houston	10.3	4.3	1.9	SP-SM
Redd Road	9.2	2.6	1.2	SP-SM
Horizon	7.9	3.0	1.3	SP-SM
NW w/Ag.	8.2	3.5	1.0	SP-SM
Acala	6.1	2.6	1.4	SP-SM
NWTLE	24.1	16.0	6.7	SM
MP 53	24.9	18.0	4.0	SM

Table 2.4: Comparison of soils tested on this project with the soils tested by Delphia (1998).

	Soil	Percent Passing No. 200 Sieve	Coefficient of Uniformity (C_u)	Coefficient of Curvature (C_c)
University of Texas - Project (0-1874)	SP	0 - 4	2 - 7	1 - 2
	SP-SM	6 - 10	2 - 4	2 - 2
	SM	24 - 25	16 - 18	4 - 7
Texas A&M University - Project (0-1431)	SP	0 - 4	1 - 8	1 - 2
	SW	1 - 5	6 - 8	1 - 2

CHAPTER THREE

TEST PROCEDURES USED

3.1 INTRODUCTION

Compaction tests were performed using five standard procedures: Modified Proctor (ASTM D-1557), TxDOT (Tx-113-E), Maximum and Minimum Index Density (ASTM D-4253 and ASTM D-4254), and British Vibratory Hammer (BS-1377) procedures. The reference standards for these procedures are listed in Table 3.1. After each of the tests for maximum density, the grain size distribution of each soil was determined from a sieve analysis to investigate if any significant particle breakage occurred during compaction. Each of the test procedures is reviewed below and results then follow in Chapters 4 through 7.

3.2 MODIFIED PROCTOR COMPACTION TEST (ASTM D-1557)

All Modified Proctor compaction tests were performed in accordance with the ASTM D-1557 standard (ASTM 1998). In the Modified Proctor procedure, soil is compacted in a standard cylindrical mold. Two different size molds are used depending upon the gradation of the soil. Both molds are 4.584-inches tall. The molds have diameters of either 4 or 6 inches, depending on which mold is used. The molds have corresponding volumes of $1/30 \text{ ft}^3$ and $1/13.33 \text{ ft}^3$. The American Society of Testing and Materials (ASTM) standard stipulates that the 4-inch diameter mold should be used if less than 7 percent by weight of the soil being tested is retained on the No. 4 sieve. When the 4-inch diameter mold is used, all materials retained on the No. 4 sieve are to be discarded. Soils with more than 7 percent retained by weight on the No. 4 sieve are to be compacted in the 6-inch diameter mold. When the 6-inch diameter mold is used, all soil retained on the $3/4$ -inch sieve is to be discarded. The Modified Proctor procedure is only applicable to soils that have less than 10 percent by weight retained on the $3/4$ -inch sieve.

To compact the soil, a loose sample is placed into the appropriate mold in five equal layers. Each layer is compacted with blows from a 10 lb hammer dropped a distance of 18 inches. Soils are compacted with twenty-five blows per layer when the 4-inch diameter mold

Table 3.1: Reference and standard designation for each test procedure used

Reference	Test Procedure	Standard Designation
American Society of Testing and Materials (1998)	Modified Proctor	ASTM D-1557
TxDOT Manual of Testing Procedures (1996)	TxDOT	Tx-113-E
American Society of Testing and Materials (1998)	Maximum Index Density	ASTM D-4253
American Society of Testing and Materials (1998)	Minimum Index Density	ASTM D-4254
British Standard Institute (1990)	British Vibratory Hammer	BS-1377

is used, and fifty-six blows per layer when the 6-inch diameter mold is used. This results in a compactive energy of 56,250 lb-ft/ft³ in either size mold. The cylindrical mold and manual drop hammer utilized for Modified Proctor compaction testing are shown in Figure 3.1. The Modified Proctor procedure also allows for use of mechanical rammers, as illustrated in Fig. 3.2, in place of the manual drop hammer.

Both the 4- and 6-inch diameter molds have a removable collar that rests on the top of the main compaction mold to keep soil from spilling from the mold during compaction. Following compaction of all five layers, the collar is removed from the top of the mold and

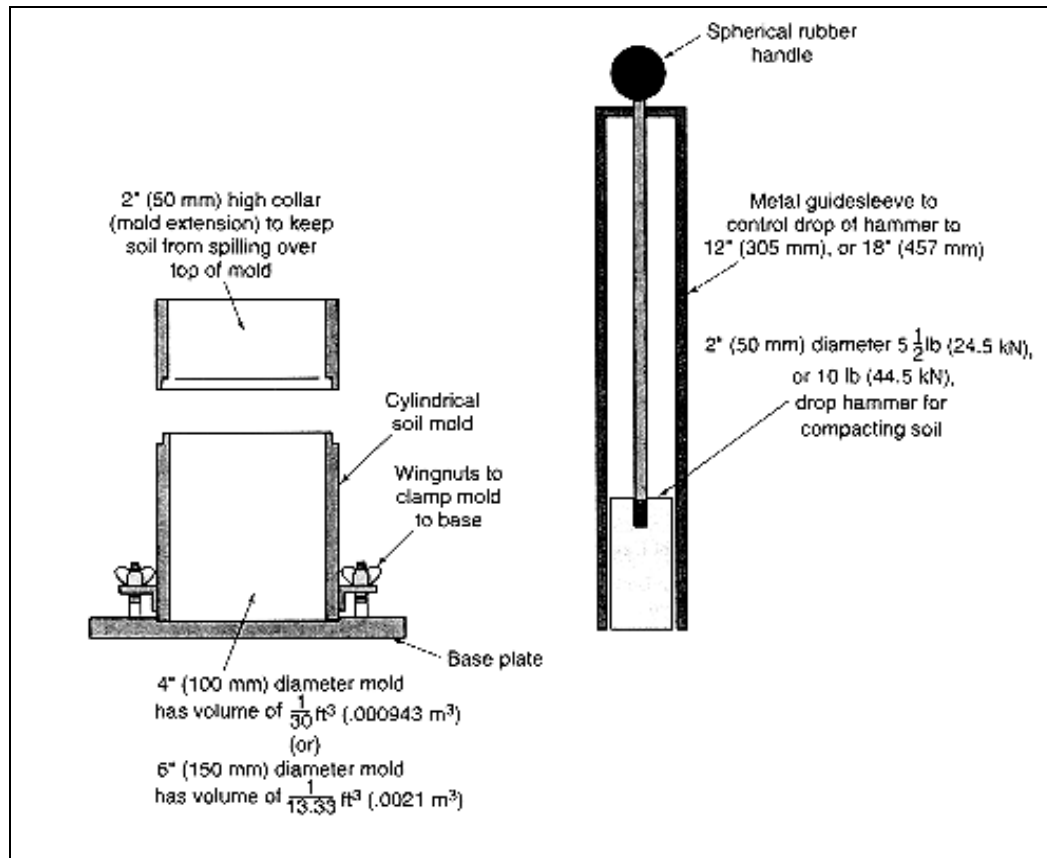

Figure 3.1: Cylindrical mold and manual drop hammer typically utilized for Standard and Modified Proctor compaction tests (McCarthy 1998)



Figure 3.2: Mechanical rammer used for Modified Proctor (ASTM D-1557) Compaction Tests

the excess soil above the top of the mold is trimmed away to create a sample with the same volume as the mold. The weight and moisture content of the compacted soil are then measured and used to compute the dry density.

Several samples of the same soil are compacted at different moisture contents and the dry density of each is computed. Soil from a previous test may not be reused. Results of the tests are used to plot a moisture-density curve representing the variation in dry density with compaction moisture content. The maximum dry density and corresponding “optimum” moisture content are determined from the moisture-density curve.

All soils tested in this study had less than 10 percent retained on the $\frac{3}{4}$ -inch sieve and the Modified Proctor procedure was therefore applicable. Thirteen of the soils had less than 7 percent passing the No. 4 sieve and were tested using the 4-inch diameter mold. The soil from the Ft. Worth District had more than 7 percent passing the No. 4 sieve and was thus tested using the 6-inch diameter mold.

3.3 TXDOT COMPACTION TEST (TX-113-E)

The Texas Department of Transportation (TxDOT) has several compaction tests to determine the moisture-density relationship of soils. The most common compaction test used by TxDOT is the Tx-114-E laboratory procedure (TxDOT Manual of Testing Procedures 1996). The Tx-114-E laboratory procedure is similar to the Standard Proctor compaction test (ASTM D-698). However, TxDOT requires the Tx-113-E laboratory procedure be used to determine the moisture-density curves of “cohesionless sands” (TxDOT Manual of Testing Procedures 1996). All compaction tests using the TxDOT procedures were performed in accordance with the Tx-113-E standard. For this method soil is compacted in a standard cylindrical mold having a diameter of 6 inches and a height of 8.5 inches. Only soil particles passing the $\frac{3}{8}$ -inch sieve are allowed; all materials retained on the $\frac{3}{8}$ -inch sieve are discarded.

In the TxDOT compaction test, a loose sample of soil is placed in the mold in eight equal layers. The method requires that a 0.5-inch thick neoprene pad be placed on top of each layer of soil for compaction. A specially designed 10 lb hammer with twin striking faces is used to compact the soil. Each layer is compacted with 100 blows from the hammer dropped

a distance of 18 inches. This results in a compactive energy of 91,673 lb-ft/ft³. The special neoprene pad and hammer are illustrated in Fig. 3.3. The mechanical rammer illustrated in Fig. 3.4 was used for all TxDOT tests.

Following compaction of the eight, approximately 1-inch thick layers, the final height of the sample is measured. A fixed dial gauge, like the one illustrated in Figure 3.5, is used to measure the final height. The TxDOT procedure requires the final compacted height of the specimen to be 8 inches \pm 0.25 inch. The weight and moisture content of the compacted sample are then determined and used to compute the dry density of the sample. Complete moisture-density curves are determined by compacting specimens at several moisture contents. Soil compacted from a previous test may not be reused.

Thirteen of the soils were tested with the TxDOT procedure. All soil particles retained on the 3/8-inch sieve were discarded for each test. The soil from Ft. Worth was not tested with the TxDOT procedure because 15 percent by weight of the soil was retained on the 3/8-inch sieve .

3.4 MAXIMUM AND MINIMUM INDEX DENSITY (ASTM D-4254 AND ASTM D-4253)

Relative densities are based on maximum and minimum dry densities of the soil. ASTM has developed procedures for determining these maximum and minimum densities known as the “Maximum and Minimum Index Densities” (ASTM D-4254 and ASTM D-4253). These ASTM test methods are to be used only for free-draining soils that contain less than 15 percent by weight passing the No. 200 sieve. The two tests are described further in the next two subsections.

3.4.1 Minimum Index Density (ASTM D-4254)

All minimum dry densities were determined using the Minimum Index Density procedure in accordance with the ASTM D-4254 standard (ASTM 1998). The Minimum Index Density test involves loosely filling a 0.1 ft³ mold with dry soil. Two methods are used to place the soil into the mold depending upon the maximum particle size. Soils with maximum particle sizes greater than 3/8-inch in nominal size are to be placed with a scoop.

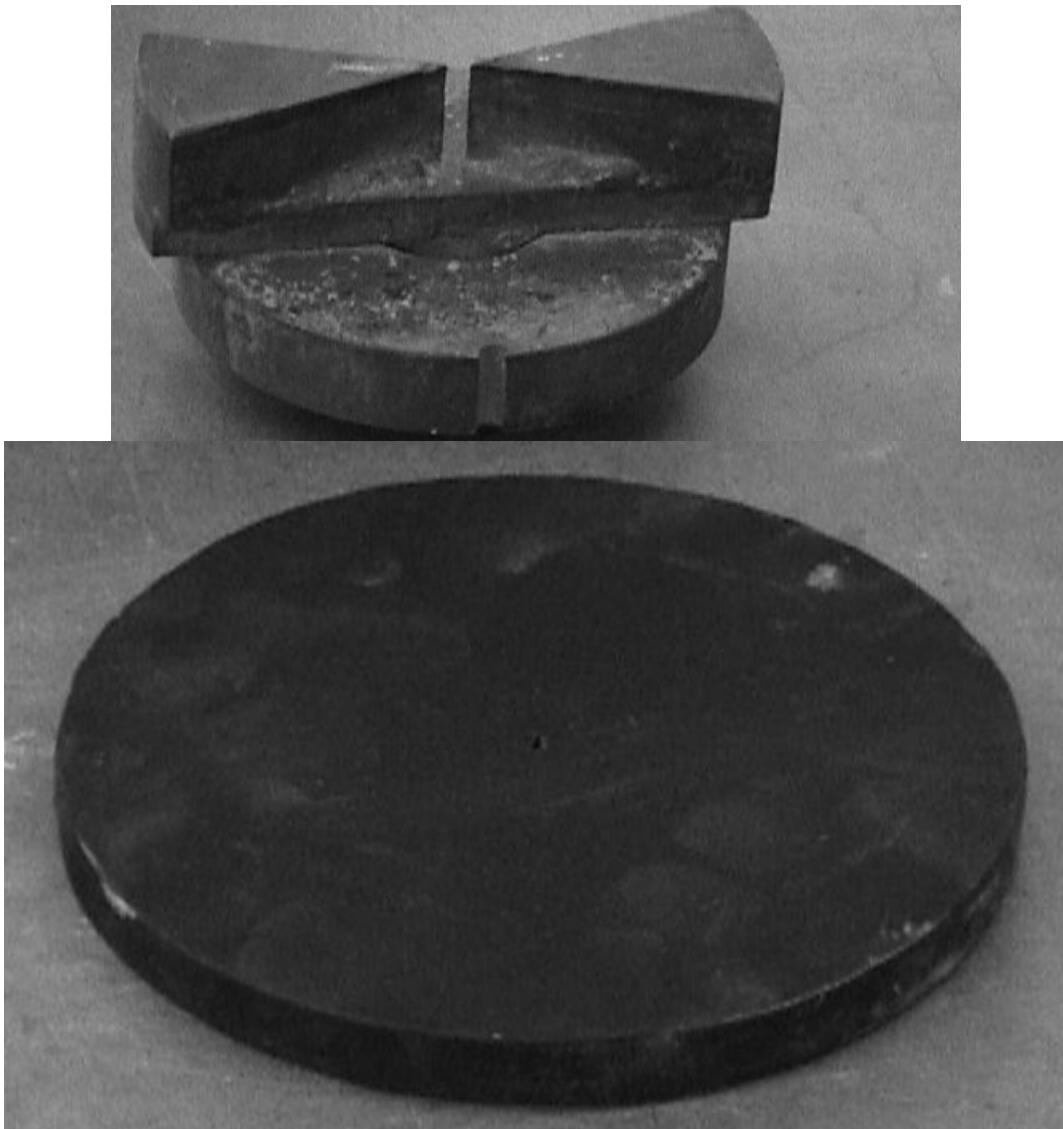

Figure 3.3: Double-faced 10 lb hammer and neoprene pad used for TxDOT compaction tests

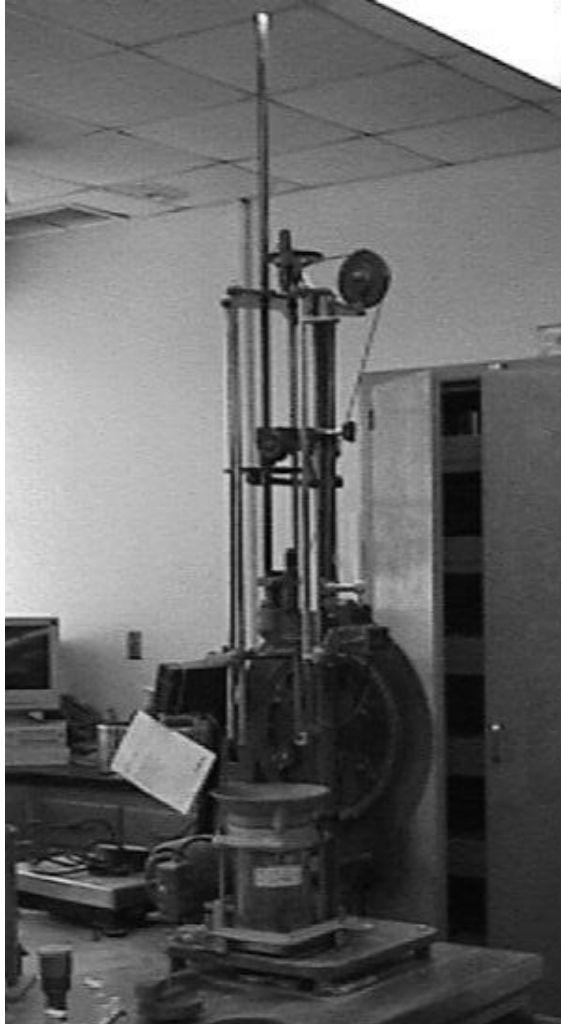

Figure 3.4: TxDOT mechanical rammer used for TxDOT compaction tests

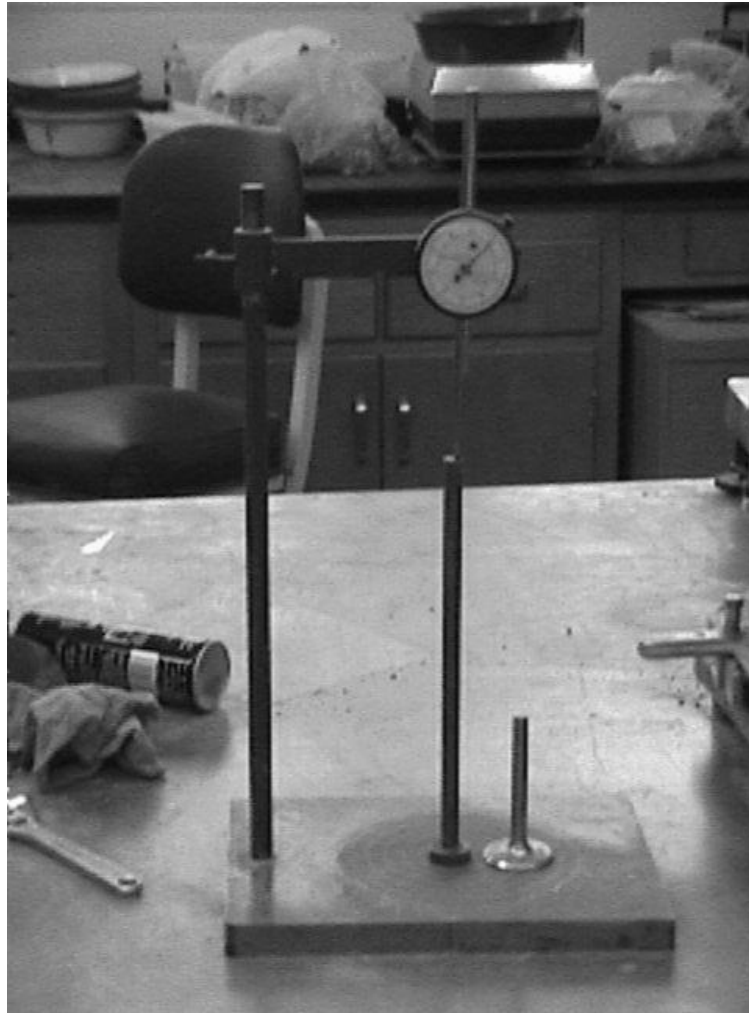

Figure 3.5: Apparatus for measuring height of sample for TxDOT compaction tests

The soil should be placed in such a way that the material slides loosely from the scoop onto previously placed soil without falling from a great height. When the maximum particle size is smaller than 3/8-inch in nominal size, a prescribed pouring device is used to place materials. The pouring device is a rigid container that holds a volume of soil 1.25 to 2 times greater than 0.1 ft³, i.e. 1/8th to 1/5th ft³. The container must be fitted with spouts or tubes about 6 inches long. Two different diameter spouts are required depending upon the gradation of the soil. A spout with an inside diameter of 1/2-inch is required for soils with maximum particle sizes less than the No. 4 sieve. A spout with an inside diameter of 1-inch is required for soils with maximum particle sizes greater than the No. 4 sieve but less than 3/8-inch. The spout is to be securely connected to the rigid container by use of a funnel or lipped brim that allows for even flow of the soil from the container through the spout. The pouring device used is illustrated in Figure 3.6. The pouring device is filled with soil, which is then allowed to flow in a steady stream into the mold. The height of fall of the soil from the spout should be approximately 1/2-inch. The soil is poured into the mold in a spiral pattern, starting from the outside of the mold and moving towards the center.

Placement of the soil with either the scoop or pouring device is to continue until the soil is slightly above the top of the mold. A steel straightedge is used to remove the material extending above the top of the mold. The weight of the soil is measured and the dry density is then computed. The dry density represents the minimum dry density according to the Minimum Index Density procedure.

Minimum densities were determined for all of the soils tested. Thirteen of the fourteen soils tested had maximum particle sizes less than 3/8-inch and were tested using the pouring device illustrated in Figure 3.6. The remaining soil was placed with a handheld scoop. The pouring device consisted of a 36-inch high PVC container with an inside diameter of 3 inches. The volume of the PVC container is approximately 1.5 ft³. A funnel was connected to the bottom of the PVC container. Six-inch long spouts of either 0.5-inch or 1-inch inside diameter were connected to the end of the funnel.

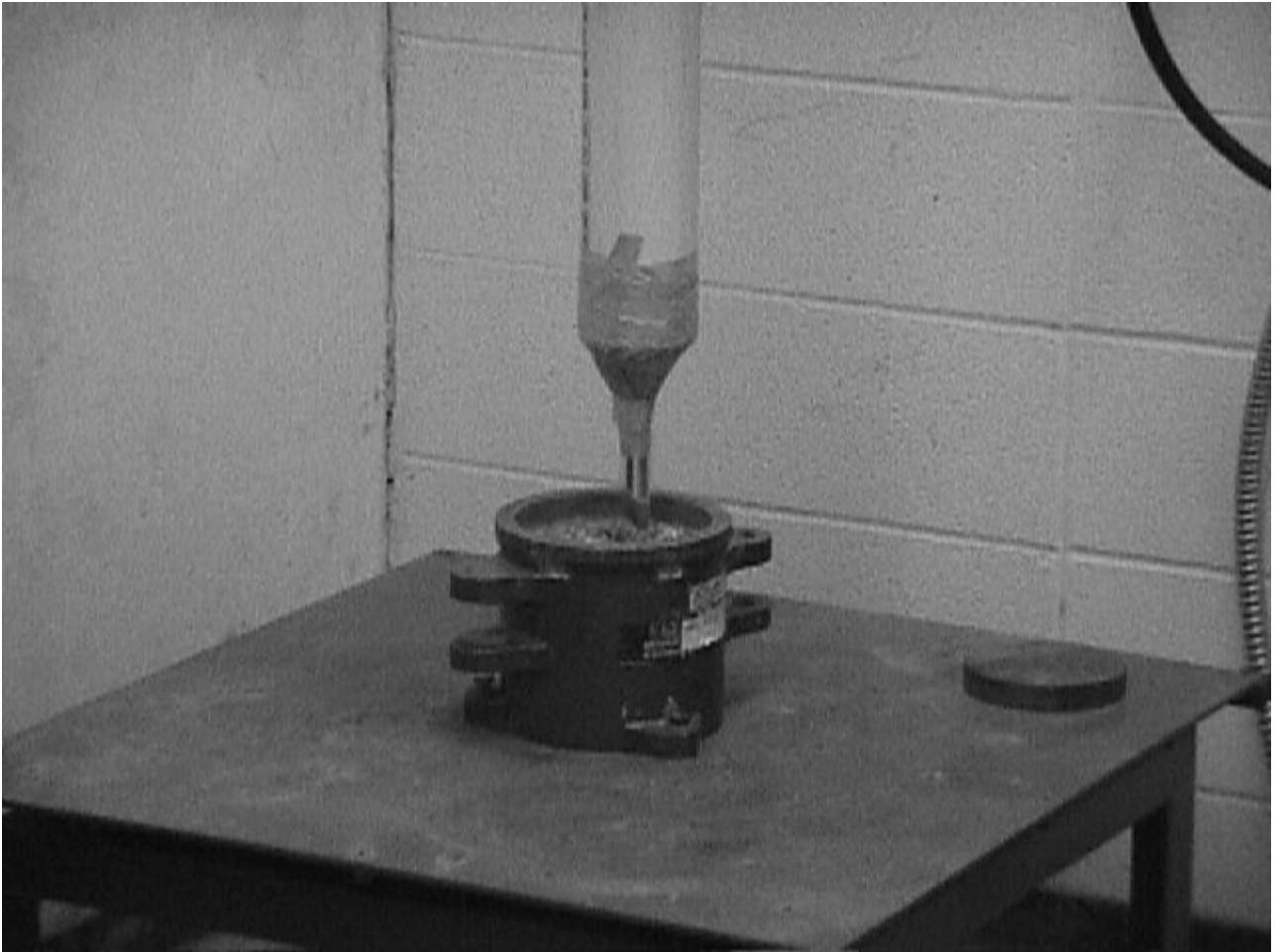

Figure 3.6: Pouring device for Minimum Index Density test

3.4.2 Maximum Density Index (ASTM D-4253)

All maximum dry densities were determined using the Maximum Index Density procedure in accordance with the ASTM D-4253 standard (ASTM 1998). To compact the soil, a standard vibratory table with an electromagnetic vibrator, like the one shown in Figure 3.7, is used. Soil is placed into a mold that is rigidly attached to the vibratory table with an electromagnetic vibrator. A weight that produces a 2 psi surcharge is placed on top of the sample. The mold is then vibrated for 8 minutes at a frequency of 60 Hz. The proper

vibrator should produce a sinusoidal time-displacement pattern having a double amplitude of vertical vibration of approximately 0.013 inches \pm 0.002 inches. The weight and volume of the soil in the mold is measured after 8 minutes of vibration and the dry density of the soil in the mold is computed. This dry density represents the maximum dry density according to the Maximum Index Density procedure.

The Maximum Index Density procedure requires that the vibratory table operate at an amplitude of vibration that produces the maximum dry density for the soil being tested. This amplitude is called the “optimum” amplitude of vibration. Changes in soil type and gradation can significantly alter the optimum amplitude of vibration. Therefore, the vibratory table must be calibrated to operate at the optimum amplitude of vibration for specific soils or gradations.

Two different methods are specified for determining the Maximum Index Density. The first method, termed the “Dry” Method, involves placing oven-dried soil into the mold and determining the maximum density by the procedures described in the preceding paragraphs. The Dry Method requires that the soil be loosely placed into the mold using the same procedures specified for the Minimum Index Density standard. The second method, termed the “Wet” Method, requires that water be mixed with oven-dried material prior to vibration. The vibrating table is turned on, and the wet soil is slowly placed into the mold in stages. Additional soil is not placed in the mold until free water begins to accumulate on the surface of the vibrating soil already in the mold. If no free water appears at the surface, then small amounts of water are added. Occasionally, the amplitude of vibration must be changed to prevent excessive boiling or fluffing of the soil. The standard 2 psi surcharge weight is placed on the soil after the mold is completely filled with soil. The sample is then vibrated for 8 minutes at 60 Hz, at an amplitude that produces the maximum dry density. After vibration, the volume of the sample is measured and the wet sample is oven-dried to compute the dry density. An initial series of tests was performed using both the Wet and Dry Methods on selected poorly graded sand (SP), poorly graded sand with silt (SP-SM), and poorly graded silty sand (SM) soils. As shown in Table 3.2, the maximum dry densities determined by the Dry Method were always at least as high as those obtained using the Wet Method. Accordingly, the Dry Method was used for all subsequent tests to determine the Maximum



Figure 3.7: Vibratory table for Maximum Index Density (ASTM D-4253) test

Index Density. The vibratory table was calibrated to operate at the optimum amplitude of vibration for each of the initial five soils tested (Table 3.2). The table operated at a frequency of 60 Hz and the double amplitude of vibration was approximately 0.013 in. \pm 0.005 in. for the soils tested. The settings were then used to perform tests on other soils that had gradations and USCS classifications similar to those in Table 3.2. According to ASTM and the Maximum Index Density procedure, the procedure was not suitable for testing the two SM soils in this study because the soils had more than 15 percent by weight passing the No.

200 sieve. Nevertheless, the maximum dry densities of the SM soils were determined using the Maximum Index Density procedure and the values are reported for information only.

Table 3.2: Maximum dry densities determined by the Wet Method and Dry Method according to ASTM D-4253 for selected SP, SP-SM, and SM soils

Soil	Dry Method - Maximum Dry Density, lb/ft ³	Wet Method - Maximum Dry Density, lb/ft ³	USCS Classification
McNary	110.0	109.2	SP
Ft. Worth	121.1	120.5	SP
Corpus Christi	105.6	105.5	SP
Horizon	109.1	107.6	SP-SM
NWTLE	106.9	102.3	SM

3.5 BRITISH VIBRATORY HAMMER (BS-1377)

The British Standard Institute (BSI) has standardized the “British Vibratory Hammer” procedure, specified as the BS-1377 standard procedure (BSI 1990). In this procedure, a vibratory hammer and circular tamping foot are used to compact the soil in a standard cylindrical mold. A typical vibratory hammer and tamping foot are illustrated in Figure 3.8. The British Vibratory Hammer procedure was used extensively in the previous study by Delphia (1998). Based on that study, the procedure was recommended to TxDOT for determining the maximum dry density of cohesionless soils.

All compaction tests with the British Vibratory Hammer were performed in accordance with the British Vibratory Hammer standard (BSI 1998). This procedure is only applicable for soils having less than 30 percent by weight retained on the ¾-inch sieve and less than 10 percent retained on the 1.5-inch sieve. All materials greater than ¾-inch are to be discarded. Prior to compaction, specimens are prepared at different moisture contents in

the same manner as for the Modified Proctor test. Soil is loosely placed in a 6-inch diameter mold in three equal layers.

Each layer is compacted for one minute with a vibrating hammer. The hammer has a circular tamping foot that is placed directly on top of each layer of soil. The final compacted height of the specimen is between 5 inches and 5.25 inches. The hammer operates at a frequency ranging from 1,500 to 2,500 cycles/min. During compaction, a constant vertical force ranging from 70 lb to 90 lb is supposed to be maintained on the hammer. A critical component of the British Vibratory Hammer test is maintaining this vertical force for the duration of the test. The standard recommends that individual persons should place the hammer on a scale and determine the amount of effort necessary to apply the acceptable range of force by each person. A metal loading frame with a lever arm, such as illustrated in Fig. 3.9, may be used to apply a more consistent force.

Following compaction of the three layers of soil, the height of the sample is measured directly with a fixed dial gauge similar to the one illustrated in Fig 3.5. The weight and moisture content of the compacted soil are then determined and used to compute the dry density. Complete moisture-density curves are determined by repeating the procedure at various moisture contents. Soil compacted in a previous test may not be used.

3.6 SUMMARY OF TEST PROCEDURES USED

All of the compaction tests in this study were performed using the standard procedures described in this chapter. The reference standards for these procedures are listed in Table 3.1. In the next four chapters (4 through 7), the results of the various compaction tests performed are presented for the fourteen soils described in Chapter 2.

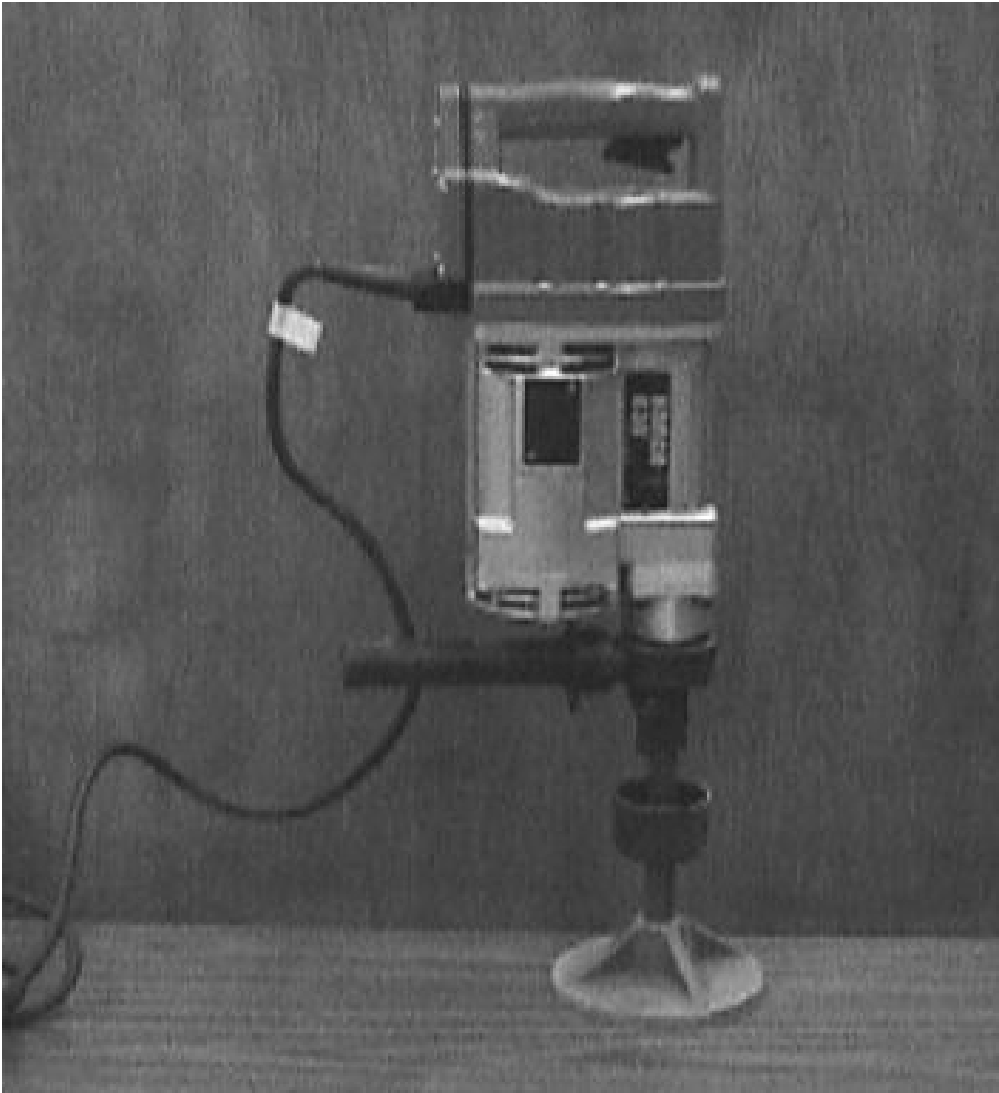

Figure 3.8: British Vibratory Hammer

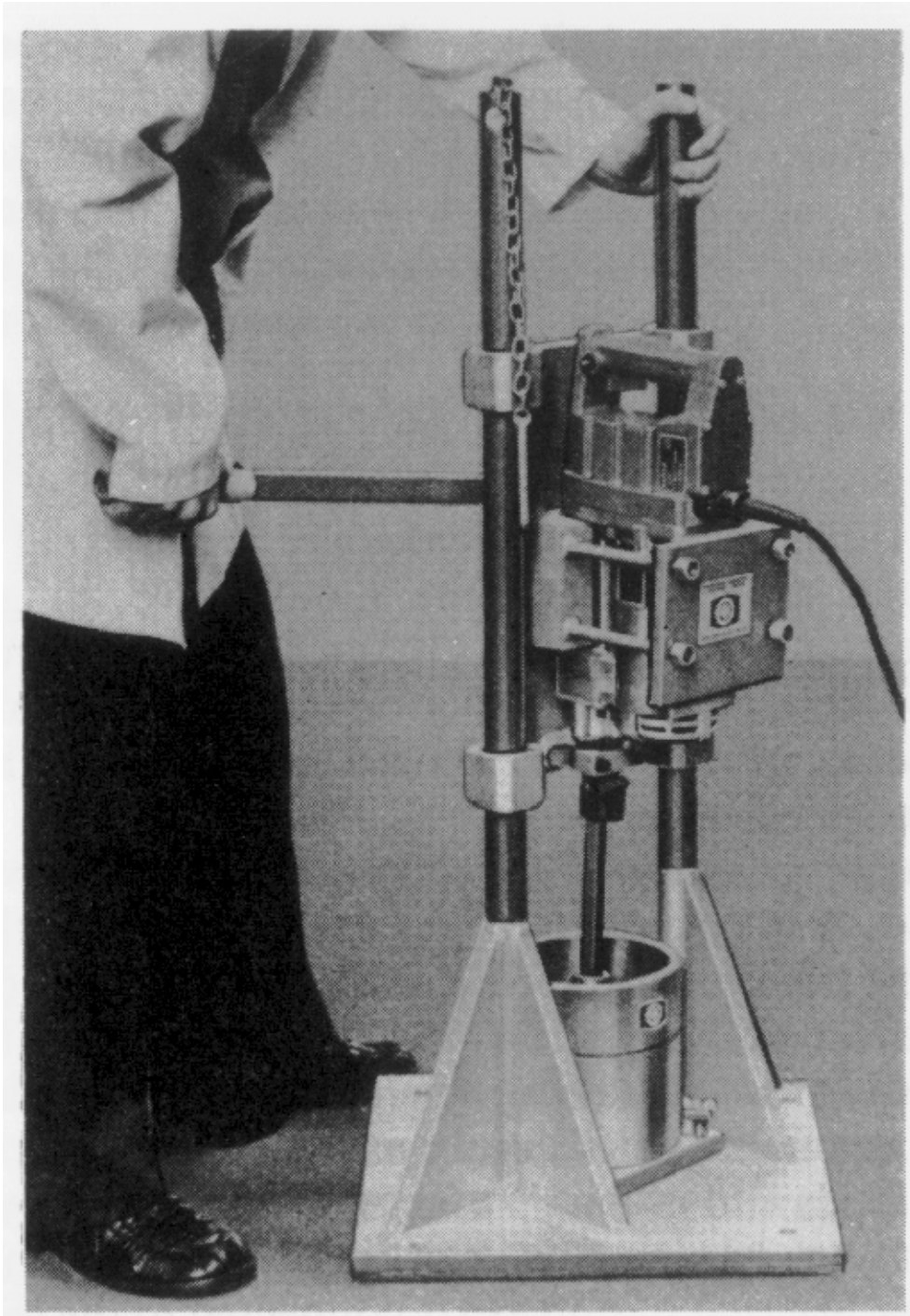

Figure 3.9: British Vibratory Hammer with frame and lever arm (Head 1980)

CHAPTER FOUR

COMPACTION TEST RESULTS FOR THE MODIFIED PROCTOR COMPACTION PROCEDURE

4.1 INTRODUCTION

Modified Proctor compaction tests were performed on the fourteen soils selected for this study. The tests were performed in accordance with the ASTM D-1557 procedure described in Chapter 3. Sieve analyses were also conducted to determine the grain size distribution of the soil after each compaction test. By comparing the grain size distribution curves for each soil before and after compaction, it was possible to determine how much particle breakage, if any, occurred. The grain size distribution curves for all soils before and after compaction are presented in Appendix A.

4.2 MOISTURE-DENSITY CURVES

The maximum dry unit weight and optimum moisture content determined from the Modified Proctor compaction tests are summarized in Table 4.1. The moisture-density relationships for the soils classified as poorly graded sand (SP) are shown together for comparison in Figure 4.1. Similar curves are shown for the soils classified as poorly graded sand with silt (SP-SM) and poorly graded silty sand (SM) soils in Figures 4.2 and 4.3, respectively.

The soils classified as SP soils generally did not have compaction curves with a well-defined maximum dry density and optimum moisture content, with the exception of the soil from Ft. Worth. Generally, the moisture-density curves were relatively flat with little change in dry density over a wide range of moisture content. Most of the SP soils displayed a maximum dry density at essentially zero moisture content.

A close examination of the moisture-density curves for the soils designated Plant #9, McNary, NW No Ag., and Beaumont revealed the presence of multiple “humps” in the moisture-density curve. In order to determine if the “humps” in the compaction curve shown in Figure 4.1 were statistically significant, six essentially identical compaction tests were

Table 4.1: Maximum dry density and optimum moisture content from Modified Proctor (ASTM D-1557) compaction tests

Soil	Maximum Dry Density, lb/ft ³	Optimum Moisture Content, %
Plant #9	116.5	5.1
McNary	106.5	0.5
NW No Ag.	106.3	9.8
Ft. Worth	127.9	8.3
Corpus Christi	105.2	2.0
Beaumont	104.8	0.1
Austin	104.8	9.9
Houston	113.2	8.3
Redd Road	112.5	9.2
Horizon	111.5	5.4
NW w/Ag.	111.0	10.0
Acala	118.3	9.3
NWTLE	120.1	12.0
MP 53	118.6	11.6

Figure 4.1: Moisture-density curve of poorly graded sands (SP) from Modified Proctor compaction (ASTM D-1557)

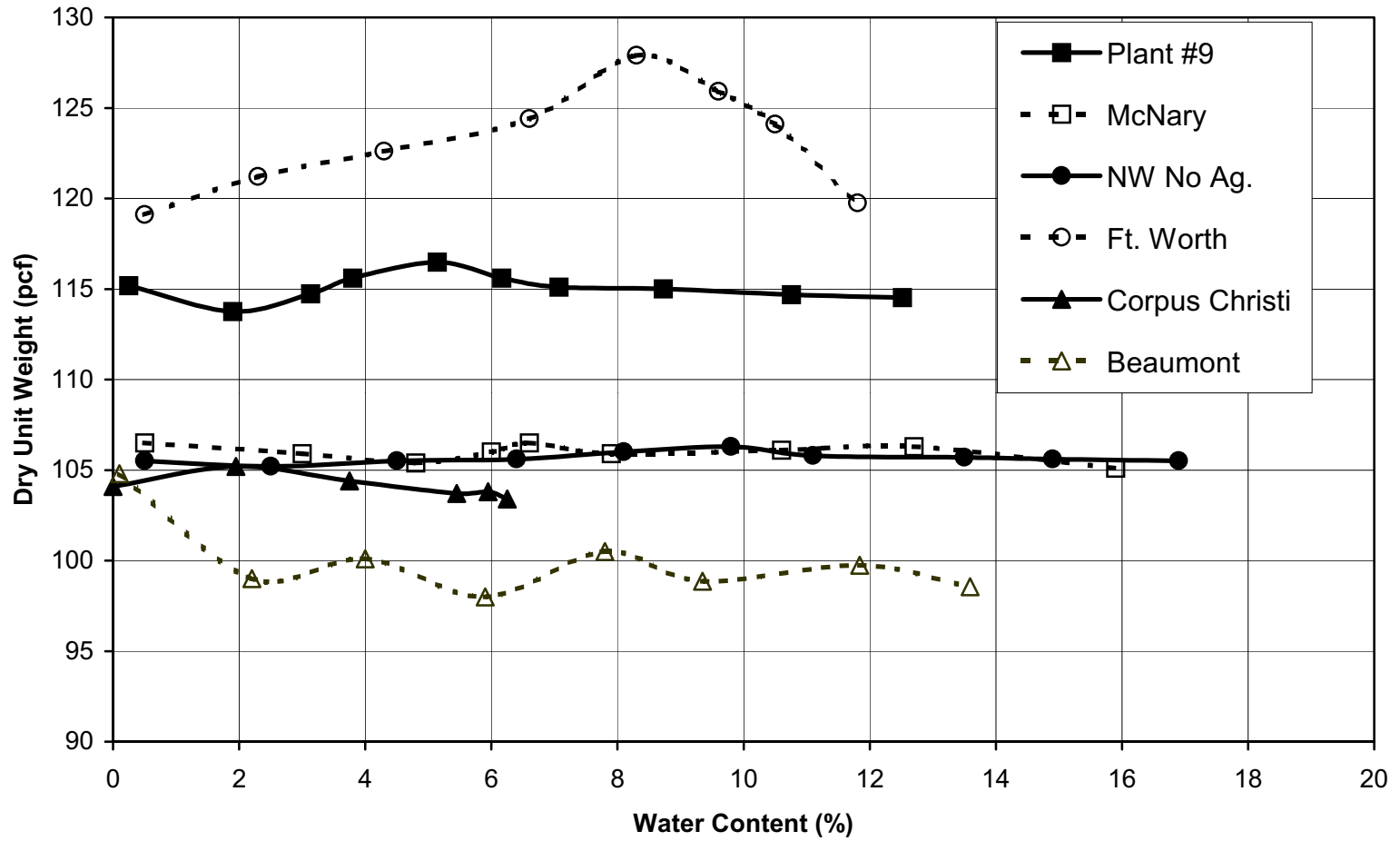

Figure 4.2: Moisture-density curve of poorly graded sands with silt (SP-SM) from Modified Proctor compaction (ASTM D-1557)

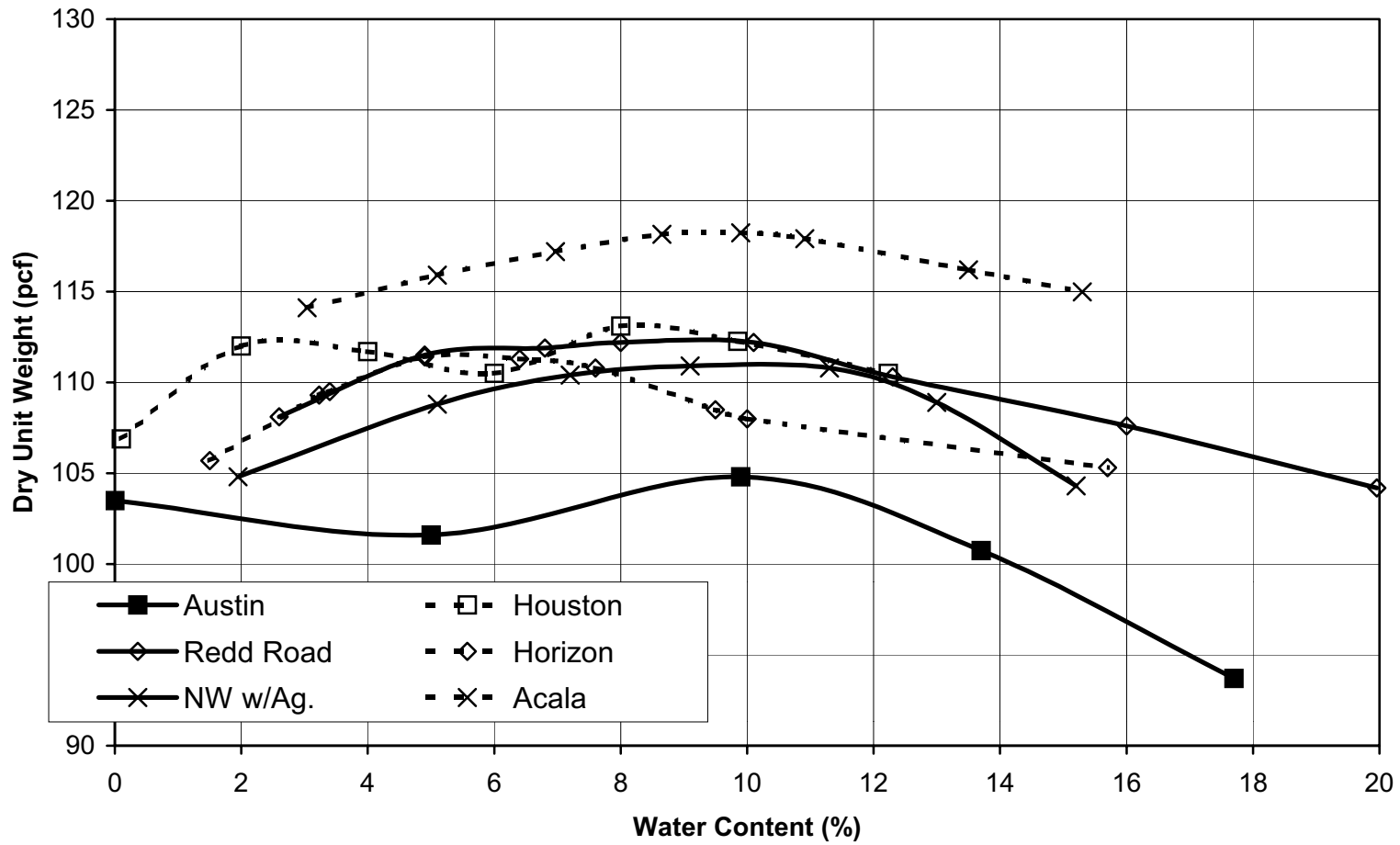
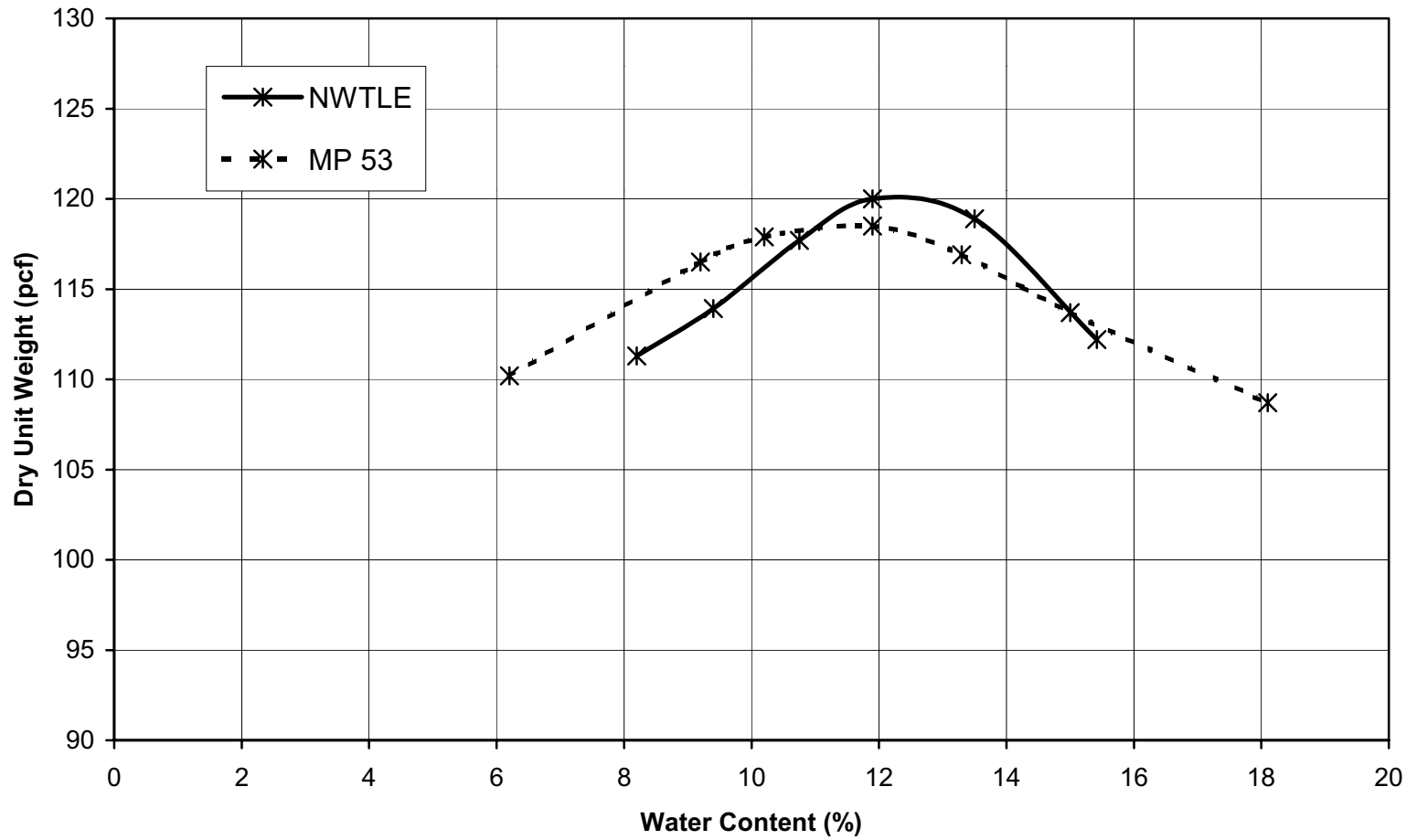

Figure 4.3: Moisture-density curve of poorly graded silty sand (SM) from Modified Proctor compaction (ASTM D-1557)



performed at each of two moisture contents, 5 percent and 7 percent, on the soil from Beaumont. The results of these additional tests are summarized in Table 4.2. The standard deviation of the dry densities obtained at each of these two moisture contents was approximately 1 lb/ft³. Also, the average values of the dry densities obtained from tests at 5 and 7 percent water content were approximately identical. In comparison, the magnitudes of the “humps” shown previously in Figure 4.1 were approximately 1.5 lb/ft³. Hence, the results summarized in Table 4.2 indicate that the multiple “humps” of the moisture-density curves are likely due to typical scatter in the data and slight variations from test to test. The humps probably do not represent statistically significant peaks (maxima) in the moisture-density relationships of the soils tested.

Table 4.2: Results of Modified Proctor compaction tests performed at identical moisture contents

Moisture Content, %	Dry Density, lb/ft ³	Average Dry Density, lb/ft ³	Standard Deviation of Dry Density, lb/ft ³
5	99.1	99.3	1.0
	100.6		
	100.1		
	97.9		
	98.3		
	99.5		
7	97.8	99.4	1.1
	98.9		
	100.4		
	99.5		
	99.1		
	100.9		

The soil from Corpus Christi could not be compacted at moisture contents greater than about 6 percent because any additional water quickly drained from the soil during compaction. An upper limit on retainable moisture was also observed during compaction of the other SP soils where water drained from the mold when the moisture content exceeded a certain amount. This upper limit on retainable moisture was, on average, 15 percent.

The soils classified as SP-SM soils and designated Redd Road, Horizon, NW w/Ag, and Acala produced moisture-density curves (Fig. 4.2) with a single, well-defined peak. However, the moisture-density curves were still relatively flat over a wide range of moisture contents. The dry density of these soils typically varied by less than 1 lb/ft³ from the maximum value over a 4 to 6 percent range of moisture contents.

The compaction moisture-density curves (Fig. 4.3) of the two soils classified as SM soils produced a single, well-defined peak. The moisture-density curves were not as flat as the ones for the SP and SP-SM soils. The dry densities for the SM soils dropped significantly as moisture contents varied away from optimum.

4.3 PARTICLE BREAKDOWN

A comparison was made between the grain size distribution curves for each soil before and after compaction to determine how much, if any, particle breakage occurred during compaction. Complete grain size curves for each soil before and after compaction are presented in Appendix A. The only observed particle breakage was a measured increase in the percent passing the No. 200 sieve before and after compaction. These differences in percent passing the No. 200 sieve are presented in Table 4.3 for each soil. The average increase in percent passing the No. 200 sieve are 0.7, 1.3, and 6.3 for the soils classified as SP, SP-SM, and SM soils, respectively. The SM soils exhibited the largest increase in percent passing the No. 200 sieve. The largest increase in fines was 8.6 percent for the soil designated MP 53. This large increase was primarily due to the breakdown of caliche in the soil.

Table 4.3: Change in Percent Passing #200 Sieve by modified Proctor (ASTM D-1557) compaction tests

Soil	Initial % Passing #200 Sieve	Final % Passing #200 Sieve	Change in % Passing #200 Sieve
Plant #9	2.0	3.2	1.2
McNary	4.0	3.9	-0.1
NW No Ag.	1.8	3.6	1.8
Ft. Worth	0.4	0.5	0.1
Corpus Christi	0.2	0.9	0.7
Beaumont	1.4	2.1	0.7
Austin	8.4	9.1	0.7
Houston	10.8	12.5	1.7
Redd Road	9.3	11.5	2.2
Horizon	7.9	7.9	0.0
NW w/Ag.	8.2	9.3	1.1
Acala	6.1	8.7	2.6
NWTLE	24.1	28.0	3.9
MP 53	24.9	33.5	8.6

CHAPTER FIVE

COMPACTION TEST RESULTS FOR THE TXDOT COMPACTION PROCEDURE

5.1 INTRODUCTION

Compaction tests employing the Texas Department of Transportation (TxDOT) Tx-113-E procedure were performed on all but one of the soils selected for this study. The soil from Ft. Worth poorly graded sand (SP) was not tested because the amount of gravel exceeded the grain size limits allowed by TxDOT's procedure. Grain size distributions were measured by sieve analyses after each compaction test to observe any particle breakdown caused by compaction. The grain size curves determined for the soil before and after compaction are presented in Appendix A.

5.2 MOISTURE-DENSITY CURVES

The maximum dry densities and optimum moisture contents determined from the TxDOT compaction tests are summarized in Table 5.1. The moisture-density curves for all of the soils classified as SP materials are shown together for comparison in Figure 5.1. Similar curves are shown for the poorly graded sand with silt (SP-SM) and poorly graded silty sand (SM) soils in Figures 5.2 and 5.3, respectively.

The compaction moisture-density curves for two of the SP soils (Plant #9 and Corpus Christi) had a single, distinct peak. However, the soil from Corpus Christi could not be compacted at moisture contents greater than about 6 percent. The high permeability of the Corpus Christi soil resulted in water draining through the sample and mold so quickly that moisture contents greater than about 6 percent could not be maintained during compaction.

The moisture-density curves for three of the soils that were classified as SP soils (McNary, NW No Ag., and Beaumont) did not exhibit well-defined peaks. The moisture-density curves for these soils were relatively flat showing little change in dry density over an approximate 12 percent range of moisture contents. The maximum dry density of each of these soils occurred at essentially 0 percent moisture content.

Table 5.1: Maximum dry density and optimum moisture content from TxDOT Proctor (Tx-113-E) compaction tests

Soil	Maximum Dry Density, lb/ft ³	Optimum Moisture Content, %
Plant #9	119.4	9.5
McNary	110.8	1.4
NW No Ag.	110.7	1.5
Ft. Worth	NA	NA
Corpus Christi	111.7	3.2
Beaumont	108.7	1.0
Austin	109.1	0.7
Houston	119.0	8.7
Redd Road	116.1	10.1
Horizon	115.1	11.4
NW w/Ag.	115.4	10.7
Acala	119.5	9.1
NWTLE	124.1	11.2
MP 53	115.9	14.5

Figure 5.1: Moisture-density curve of poorly graded sands (SP) from Tx-113-E compaction

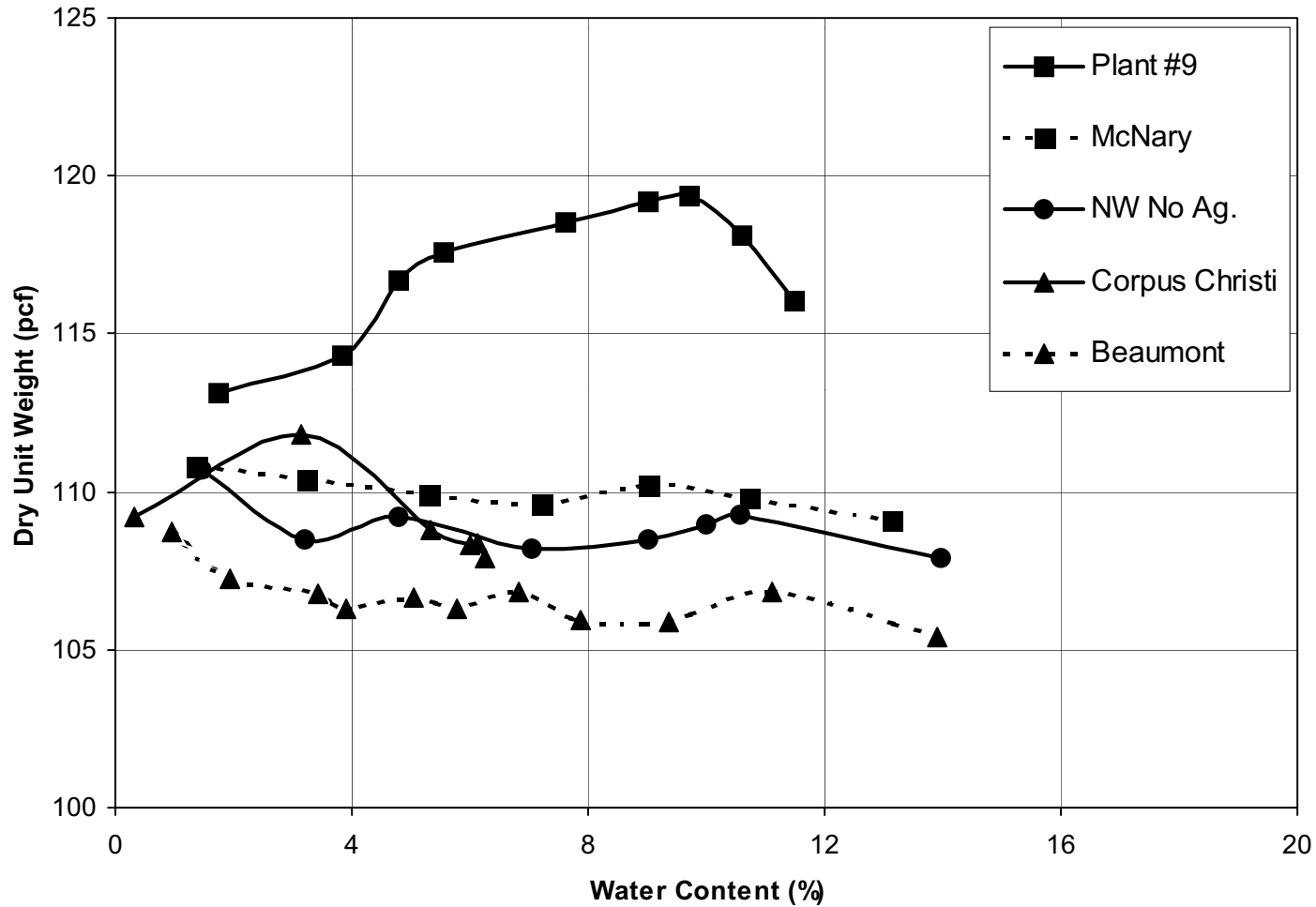

Figure 5.2: Moisture-density curve of poorly graded sand with silt (SP-SM) from Tx-113-E compaction

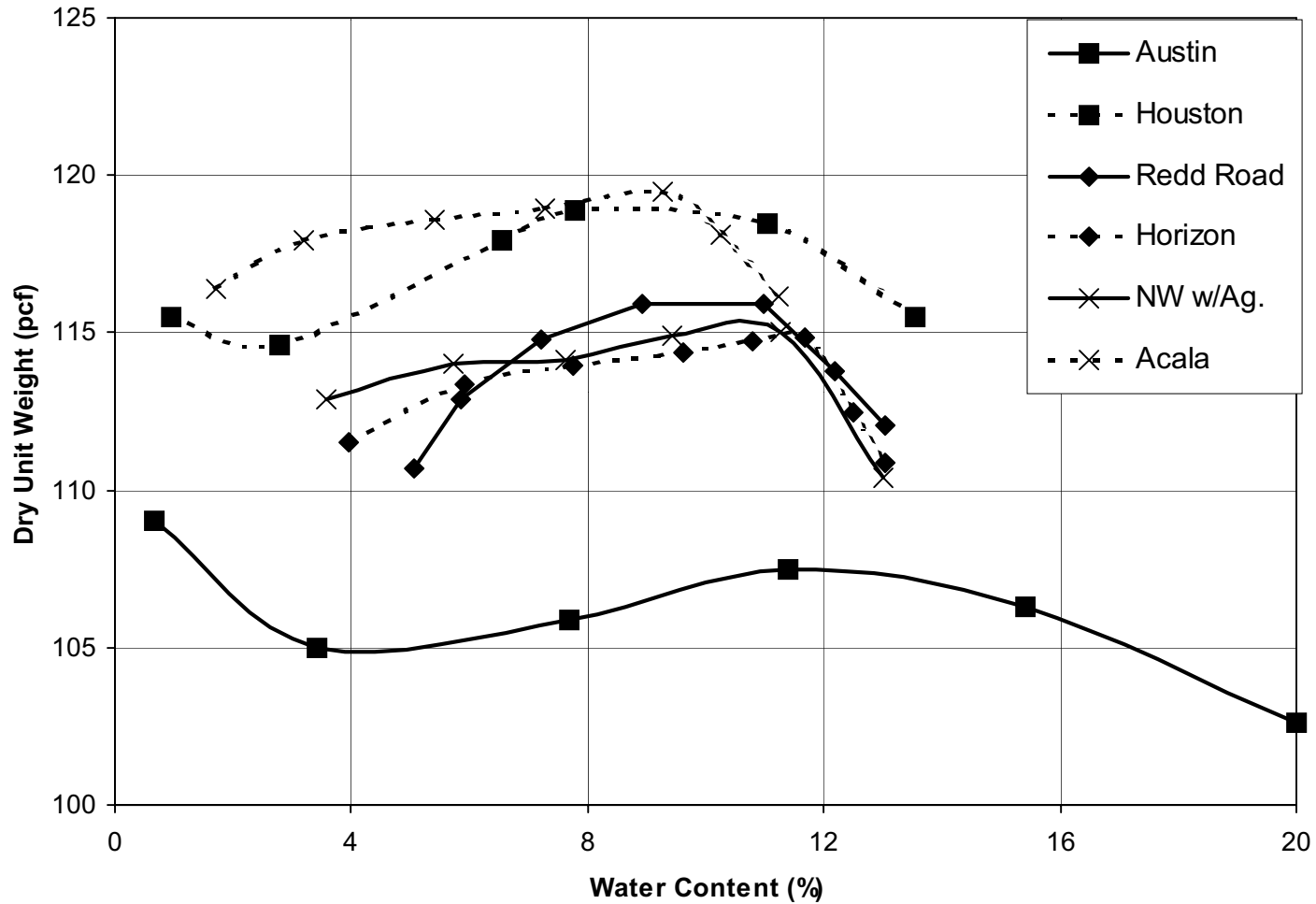
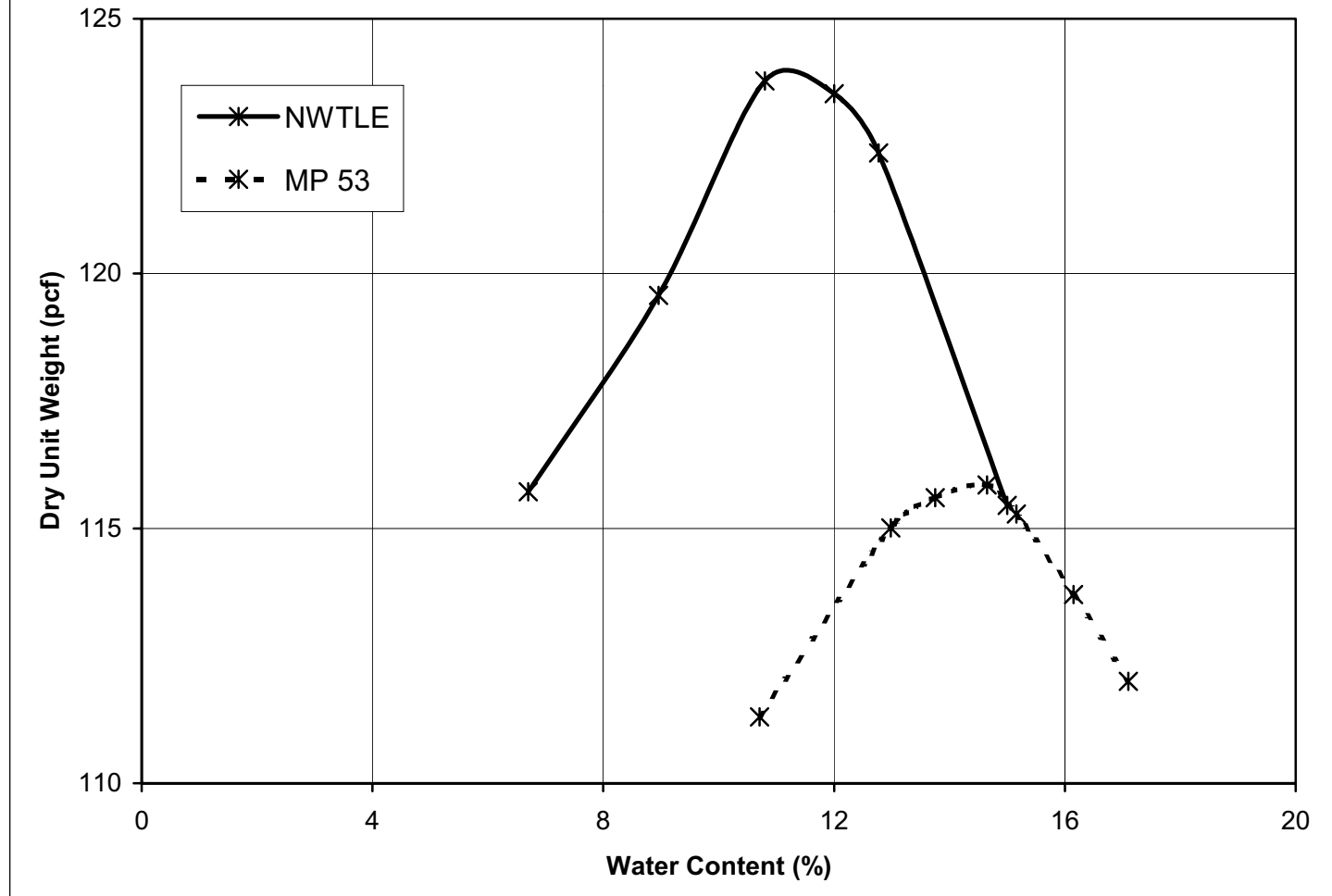

Figure 5.3: Moisture-density curve of poorly graded silty sand (SM) from Tx-113-E compaction



Four of the soils classified as SP-SM soils (Redd Road, Horizon, NW w/Ag, and Acala) produced compaction curves with single, well-defined peaks (Figure 5.2). However, the moisture-density curves still were relatively flat over a wide range of moisture contents. The dry density of the SP-SM soils remained within 1 lb/ft³ of the maximum dry density over a 3 to 5 percent range of moisture contents. However, the dry density of the soils designated Redd Road, Horizon, NW w/Ag., and Acala did decrease significantly at moisture contents greater than optimum.

The soils from Austin and Houston did not exhibit a single, well-defined peak in the compaction moisture-density curves. Single broad “peaks” in the moisture-density curves of the soils from Austin and Houston were observed at moisture contents of about 10 percent and 12 percent, respectively. The maximum dry density of soils from Austin occurred at essentially 0 percent moisture.

The moisture-density curves for the soils classified as SM soils (Fig. 5.3) showed a very well-defined peak. The dry densities of the SM soils decreased dramatically as the moisture contents varied wet or dry of the optimum value.

5.3 PARTICLE BREAKDOWN

A comparison was made between the grain size distribution curves for each soil before and after compaction to determine how much, if any, particle breakage occurred. Complete grain size distribution curves for each soil before and after compaction are presented in Appendix A. Generally, the only observed particle breakage was a measured increase in the percent passing the No. 200 sieve before and after compaction. These differences in percent passing the No. 200 sieve are presented in Table 5.2 for each soil. The average increases in percent passing the No. 200 sieve are 0.8, 1.5, and 5.2 for the SP, SP-SM, and SM soils, respectively. The SM soils exhibited the largest increase in percent passing the No. 200 sieve. The largest increase in the percent passing the No. 200 sieve was 7.2 percent for the MP 53 soil. This large increase was primarily due to the breakdown of the caliche in the MP 53 soil. Except for this one soil, the largest increase did not exceed 3.1 percent.

Table 5.2: Change in Percent Passing #200 Sieve by Tx-113-E Proctor compaction tests

Soil	Initial % Passing #200 Sieve	Final % Passing #200 Sieve	Change in % Passing #200 Sieve
Plant #9	2.0	2.8	0.8
McNary	4.0	5.0	1.0
NW No Ag.	1.8	2.7	0.9
Ft. Worth	0.4	NA	NA
Corpus Christi	0.2	1.5	1.3
Beaumont	1.4	1.4	0.0
Austin	8.4	9.4	1.0
Houston	10.8	12.3	1.5
Redd Road	9.3	11.2	1.9
Horizon	7.9	10.6	2.7
NW w/Ag.	8.2	8.2	0.0
Acala	6.1	8.1	2.0
NWTLE	24.1	27.2	3.1
MP 53	24.9	32.1	7.2

CHAPTER SIX

TEST RESULTS USING THE ASTM MAXIMUM AND MINIMUM INDEX DENSITY PROCEDURES

6.1 INTRODUCTION

Maximum and Minimum Index Densities were determined for all fourteen soils utilizing the ASTM D-4254 and ASTM D-4253 procedures for minimum and maximum densities, respectively. These procedures are intended primarily for determining maximum and minimum densities as needed to compute the relative density of cohesionless soils. Sections 3.4 and 3.5 of Chapter 3 describe the procedures.

6.2 TEST RESULTS

Minimum dry densities are summarized in Table 6.1 for the fourteen soils. The average minimum dry densities were 94.2, 91.0, and 86.5 lb/ft³ for the poorly graded sand (SP), poorly graded sand with silt (SP-SM), and poorly graded silty sand (SM) soils, respectively. The maximum dry densities obtained by the ASTM D-4254 standard are summarized in Table 6.2. The average maximum dry densities were 110.7, 109.2, and 104.1 lb/ft³ for the SP, SP-SM, and SM soils, respectively.

The SM soils had the lowest minimum and maximum densities. However, the ASTM D-4253 and ASTM D-4254 procedures are considered applicable only for soils with less than 15 percent passing No. 200 sieve, thus excluding these soils.

Consequently, the reported minimum and maximum dry densities of the SM soils may have little practical meaning.

Table 6.1: Minimum dry density from the Minimum Index Density Procedure (ASTM D-4254)

Soil	Minimum Dry Density, lb/ft ³
Plant #9	97.0
McNary	93.4
NW No Ag.	90.8
Ft. Worth	104.4
Corpus Christi	91.2
Beaumont	88.4
Austin	82.2
Houston	84.8
Redd Road	92.0
Horizon	93.0
NW w/Ag.	94.5
Acala	99.2
NWTLE	88.8
MP 53	85.0

Table 6.2: Maximum dry density from Maximum Index Density Procedure (ASTM D-4253)

Soil	Maximum Dry Density, lb/ft ³
Plant #9	112.6
McNary	110.0
NW No Ag.	108.0
Ft. Worth	121.1
Corpus Christi	105.6
Beaumont	106.8
Austin	102.7
Houston	103.5
Redd Road	109.0
Horizon	109.1
NW w/Ag.	113.2
Acala	117.9
NWTLE	106.9
MP 53	101.2

6.3 DETERMINATION OF RELATIVE DENSITIES

Ordinarily, the Maximum and Minimum Index densities determined by the ASTM D-4253 and D-4254 procedures are used to compute relative densities. Relative densities are computed using the following equation:

$$D_r = \left[\frac{(\gamma_d - \gamma_{d(\min)})}{(\gamma_{d(\max)} - \gamma_{d(\min)})} \right] \left[\frac{\gamma_{d(\max)}}{\gamma_d} \right] \quad (Eq. 6.1)$$

where D_r is the relative density, γ_d is the dry density of interest, and $\gamma_{d(\min)}$ and $\gamma_{d(\max)}$ are the Minimum and Maximum Index Densities, respectively. The maximum and minimum densities reported in Tables 6.1 and 6.2 are used later to compute relative densities for various levels of compaction based on the other compaction procedures used in this study.

CHAPTER SEVEN

COMPACTION TEST RESULTS USING THE BRITISH STANDARD COMPACTION PROCEDURE WITH A VIBRATORY HAMMER

7.1 INTRODUCTION

Six of the soils were compacted using a vibratory hammer in accordance with the British Standard, BS-1377. The test procedures were described in Section 3.6 of Chapter 3. The test results are presented and discussed below.

7.2 MOISTURE-DENSITY CURVES

The moisture-density relationships for all soils classified as poorly graded sand (SP) are shown together for comparison in Figure 7.1. Similar curves are shown for the poorly graded sand with silt (SP-SM) and poorly graded silty sand (SM) soils in Figures 7.2 and 7.3, respectively. The maximum dry densities and optimum moisture contents obtained from the various compaction curves are summarized in Table 7.1.

The compaction curves for two of the soils classified as SP soils (McNary and NW) showed no single, well-defined peak with a corresponding maximum dry density and optimum moisture content. The compaction curves for the McNary and NW No Ag. had multiple “peaks.” One of these “peaks” occurred at a moisture content of essentially 0 percent. Only the SP soil labeled Plant #9 exhibited a compaction curve with a single, well-defined peak.

The two soils that were classified as SP-SM and one soil that was classified as SM exhibited compaction curves with single, well-defined peaks. Near the optimum moisture content, the dry density of these soils typically varied by less than 1 lb/ft³ from the maximum dry density over a 3 to 4 percent range of moisture contents for the SP-SM soils tested and over a 6 percent range for the SM soil tested.

Table 7.1: *Maximum dry density and optimum moisture content from British Vibratory Hammer (BS-1337) compaction tests*

Soil	Maximum Dry Density, lb/ft ³	Optimum Moisture Content, %
Plant #9	117.4	8.7
McNary	113.2	8.3
NW No Ag.	113.4	9.1
Redd Road	115.2	8.6
Horizon	113.8	11.8
NWTLE	117.5	13.1

Figure 7.1: Moisture density curve of poorly graded sand (SP) from BS-1337 compaction

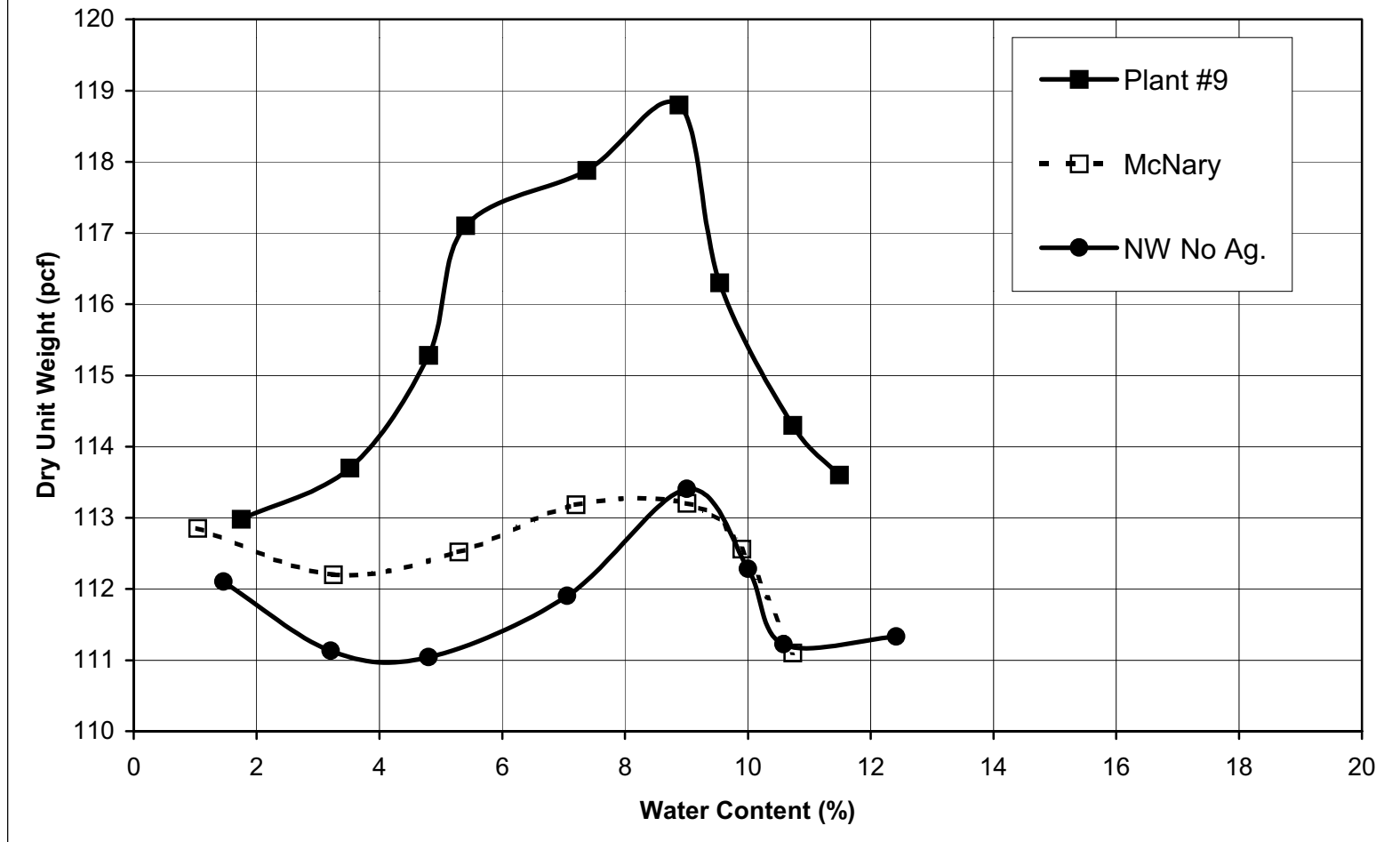

Figure 7.2: Moisture density curve of poorly graded sand with silt (SP-SM) from BS-1337 compaction

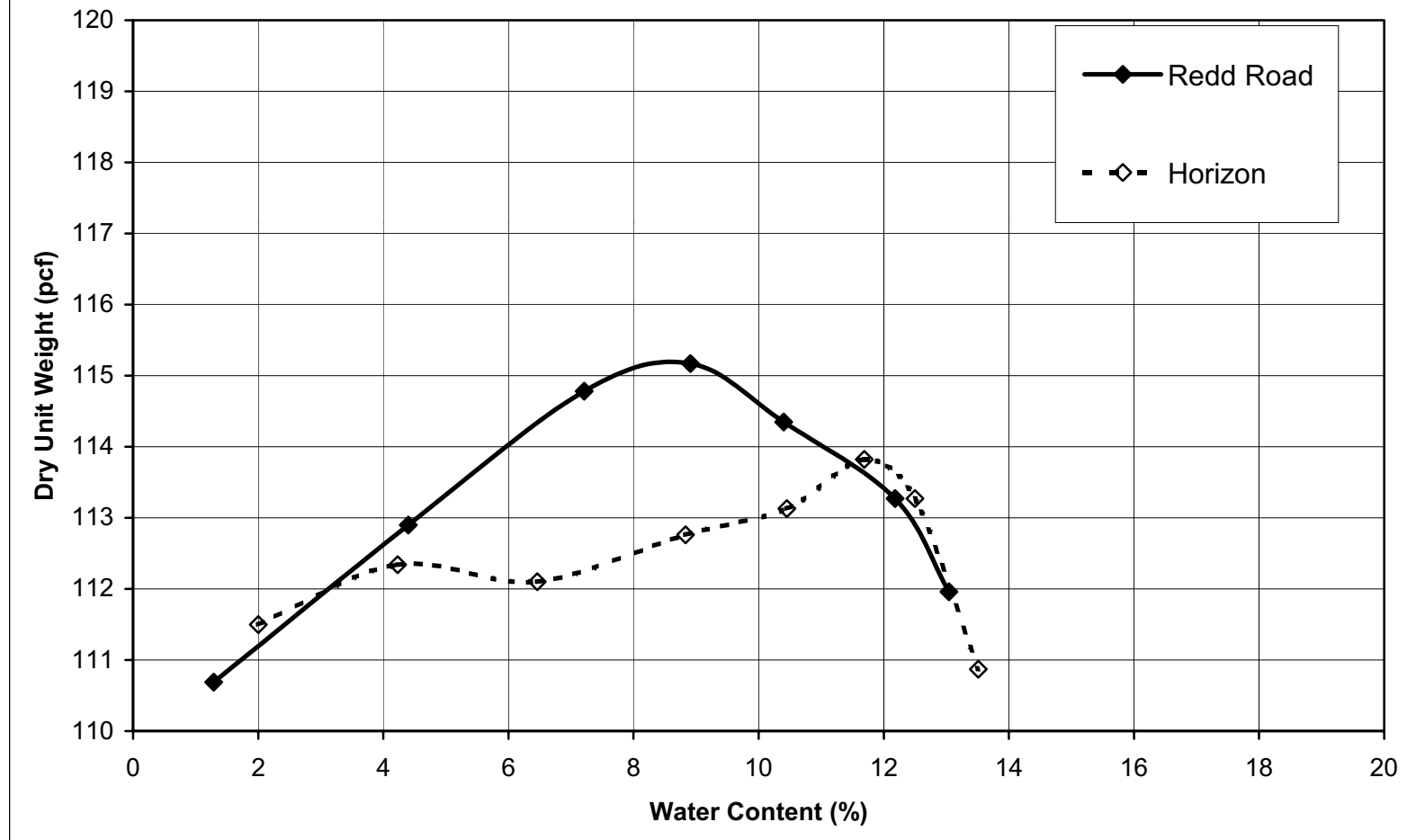
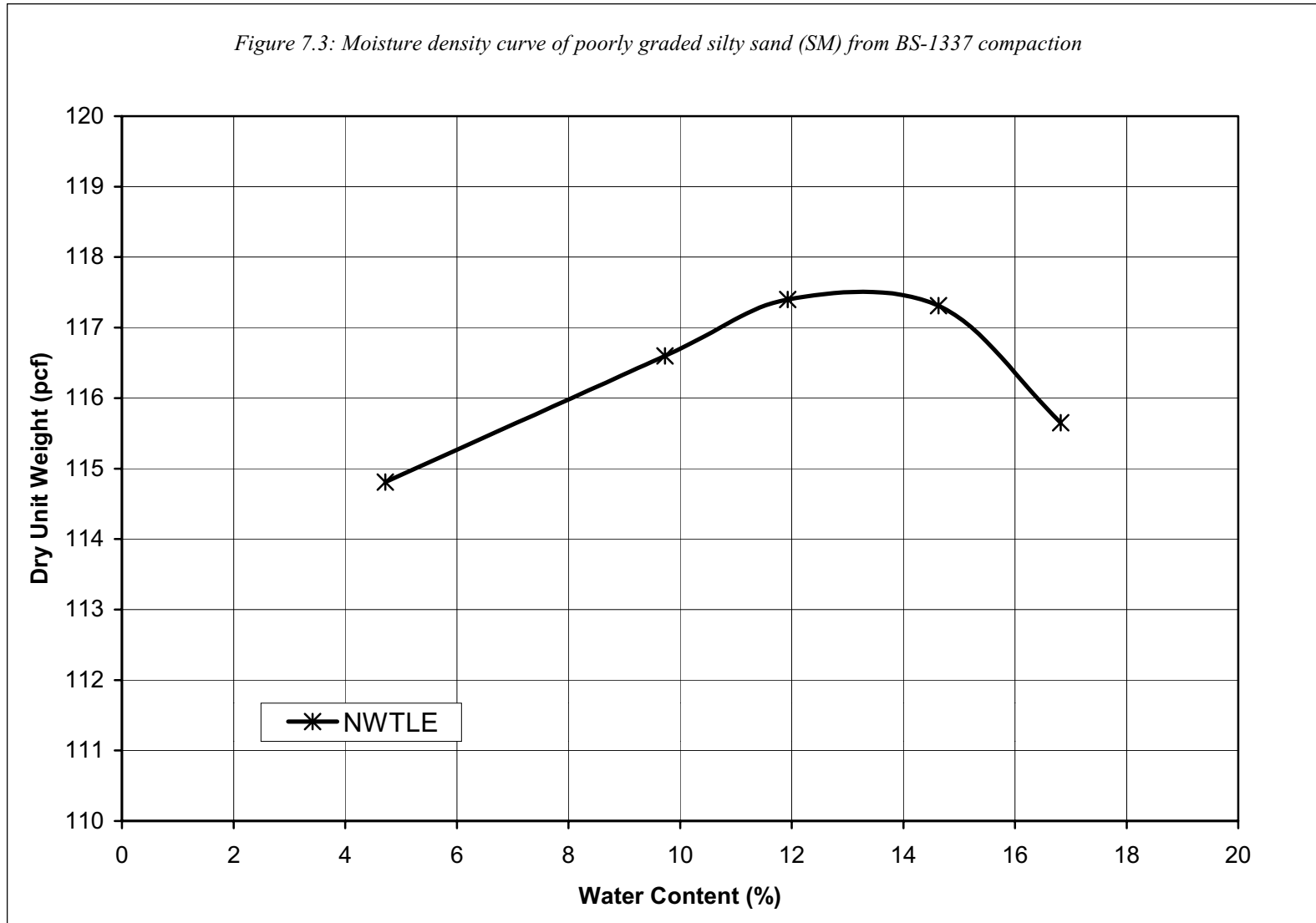

Figure 7.3: Moisture density curve of poorly graded silty sand (SM) from BS-1337 compaction



7.3 SUMMARY OF BRITISH VIBRATORY HAMMER COMPACTION TESTS

Results from the British Standard test are compared to the results of the other compaction tests summarized in Chapter 4 through Chapter 6 in the next chapter. The British Vibratory Hammer procedure was the compaction procedure examined by Delphia (1998) in the previous study sponsored by the Texas Department of Transportation (TxDOT). The recommended use of the British Standard test by Delphia (1998) is also evaluated in the next chapter based upon comparisons with data from other tests and experience gained in the current study.

CHAPTER EIGHT

COMPARISON OF TEST RESULTS

8.1 INTRODUCTION

Results of the compaction tests presented in Chapters 4 through 7 for the various compaction procedures are compared and evaluated in this chapter. Moisture-density relationships, maximum dry densities, and particle breakage during compaction are each examined and compared for the various tests. Where possible, results of this study are compared with data from the literature as well as results of the study reported by Delphia (1998).

8.2 MAXIMUM DRY DENSITY

Maximum dry densities were determined using the Modified Proctor (ASTM D-1557), Maximum Index Density (ASTM D-4253), TxDOT (Tx-113-E), and British Vibratory Hammer (BS-1377) compaction procedures. The maximum dry densities determined from the Modified Proctor, Maximum Index Density, and the Texas Department of Transportation (TxDOT) tests for fourteen soils are presented in Table 8.1. British Vibratory Hammer tests were performed on only six of the soils, all from the El Paso area. The maximum dry densities obtained from the British Vibratory Hammer procedure are summarized with the densities from the other compaction tests in Table 8.2.

8.2.1 Comparisons of Results of Modified Proctor, TxDOT, and Maximum Index Density Tests

The Maximum Index Density test has often been considered the most appropriate procedure for determining the maximum dry density of cohesionless soils (Holtz 1973; Das 1994). In the next three sections, the densities determined by the Modified Proctor and TxDOT compaction procedures are compared to the Maximum Index Density values and to each other.

Table 8.1: Maximum dry density (lb/ft³) from Maximum Index Density (ASTM D-4253), Modified Proctor (ASTM D-1557), and TxDOT (Tx-113-E) procedures

Soil	Maximum Index Density	Modified Proctor	TxDOT
Plant #9	112.6	116.5	119.4
McNary	110.0	106.5	110.8
NW No Ag.	108.0	106.3	110.7
Ft. Worth	121.1	127.9	NA
Corpus Christi	105.6	105.2	111.7
Beaumont	106.8	104.8	108.7
Austin	102.7	104.8	109.1
Houston	103.5	113.2	119.0
Redd Road	109.0	112.5	116.1
Horizon	109.1	111.5	115.1
NW w/Ag.	113.2	111.0	115.4
Acala	117.9	118.3	119.5
NWTLE	106.9	120.1	124.1
MP 53	101.2	118.6	115.9

Bold values, e.g., **119.4**, indicate maximum value for each soil by compaction procedures shown.

Table 8.2: Maximum dry density (lb/ft³) from Maximum Index Density (ASTM D-4253), Modified Proctor (ASTM D-1557), TxDOT (Tx-113-E) procedures, and the **British Vibratory Hammer (BS-1337) procedures**

Soil	Maximum Index Density	Modified Proctor	TxDOT	British Vibratory Hammer
Plant #9	112.6	116.5	119.4	117.4
McNary	110.0	106.5	110.8	113.2
NW No Ag.	108.0	106.3	110.7	113.4
Redd Road	109.0	112.5	116.1	115.2
Horizon	109.1	111.5	115.1	113.8
NWTLE	106.9	120.1	124.1	117.5

Bold values, e.g., **119.4**, indicate maximum value for each soil by compaction procedures shown.

8.2.1.1 Comparison between Results of Modified Proctor and Maximum Index Density Tests

The maximum dry densities for the Modified Proctor and Maximum Index Density tests are shown for comparison in Table 8.3. The differences in maximum dry densities were computed and are also shown in this table. The ratio of the maximum dry density obtained in the Modified Proctor test to the Maximum Index Density was computed for each soil. These ratios are presented in Figure 8.1 separately for each group of soil (based on the Unified Soil Classification System (USCS) classification). The maximum dry densities obtained from the Modified Proctor test are equal to or greater than the densities from the Maximum Index Density test for three of six poorly graded sand (SP) soils, five of six poorly graded sand with silt (SP-SM) soils, and all of the poorly graded silty sand (SM) soils tested. The maximum dry densities obtained by the Modified Proctor were greater than those obtained by the Maximum Index Density procedure by an average of 0, 2, and 15 percent for the SP, SP-SM, and SM soils, respectively.

8.2.1.2 Comparison between Results of TxDOT and Maximum Index Density Tests

The maximum dry densities for the TxDOT and Maximum Index Density tests are shown for comparison in Table 8.4. The differences in maximum dry densities were computed and are also shown in Table 8.4. The ratio of the maximum dry densities obtained in the TxDOT test to the Maximum Index Density was computed for each soil. These ratios are presented in Figure 8.2 and grouped according to the USCS soil classification of the soil tested. The TxDOT procedure produced maximum dry densities greater than the Maximum Index Density procedure for every soil tested. The maximum dry densities obtained by the TxDOT procedure exceeded those of Maximum Index Density procedure by an average of 4, 6, and 15 percent for the SP, SP-SM, and SM soils, respectively.

Table 8.3: Difference between maximum dry density (lb/ft³) from Modified Proctor (ASTM D-1557) and Maximum Index Density (ASTM D-4253) tests

Soil	Modified Proctor	Maximum Index Density	(Maximum Index Density) - (Modified Proctor)
Plant #9	116.5	112.6	-3.90
McNary	106.5	110.0	3.50
NW No Ag.	106.3	108.0	1.70
Ft. Worth	127.9	121.1	-6.80
Corpus Christi	105.2	105.6	0.40
Beaumont	104.8	106.8	2.00
Austin	104.8	102.7	-2.10
Houston	113.2	103.5	-9.70
Redd Road	112.5	109.0	-3.50
Horizon	111.5	109.1	-2.40
NW w/Ag.	111.0	113.2	2.20
Acala	118.3	117.9	-0.40
NWTLE	120.1	106.9	-13.20
MP 53	118.6	101.2	-17.40

Bold values, e.g., **116.5**, indicate maximum value for each soil by compaction procedures shown.

Figure 8.1: Comparison of maximum dry density (lb/ft^3) from Modified Proctor (ASTM D-1557) and Maximum Index Density (ASTM D-4253) procedures

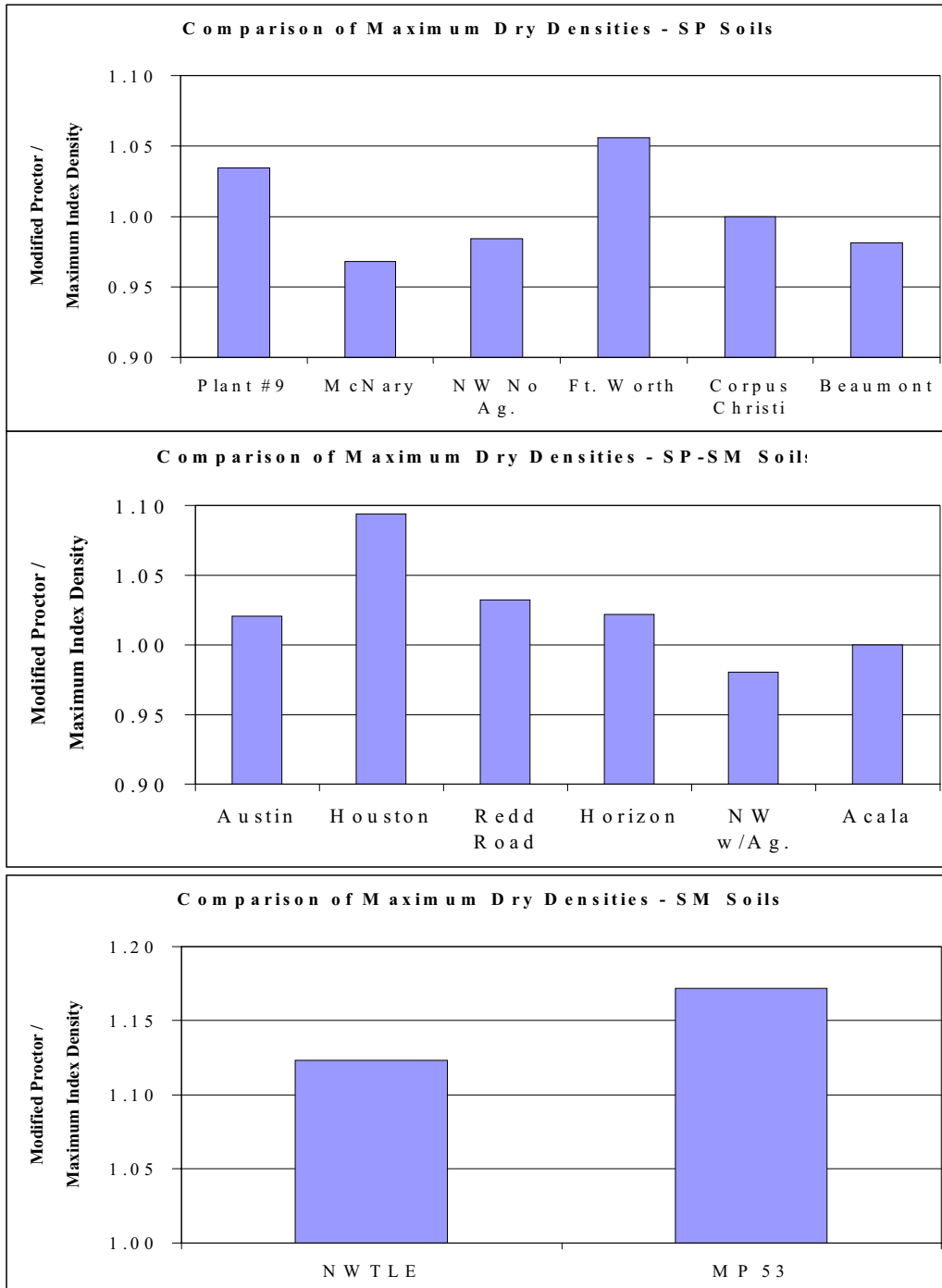
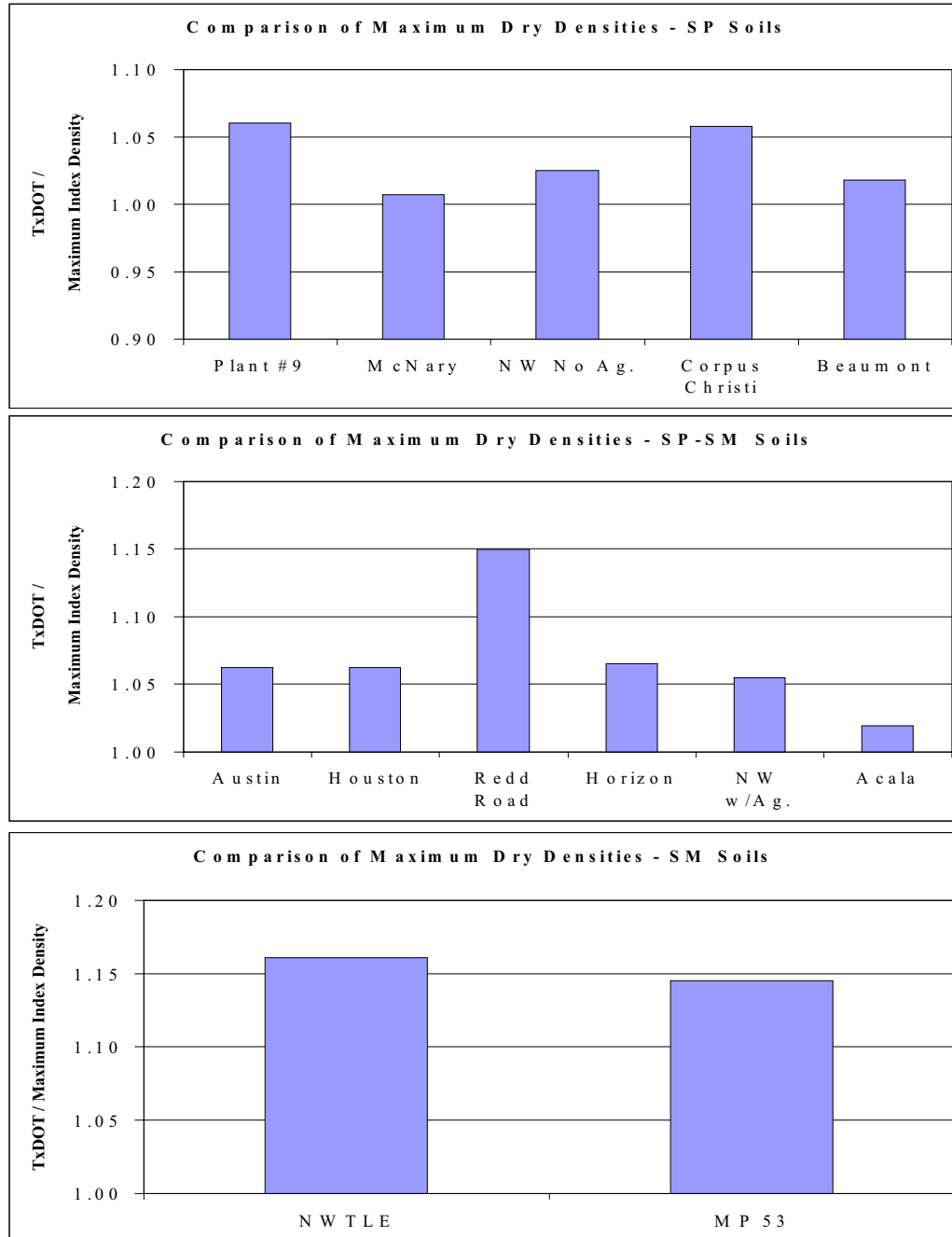

Table 8.4: Difference in maximum dry density (lb/ft³) between TxDOT (Tx-113-E) and Maximum Index Density (ASTM D-4253) tests

Soil	TxDOT	Maximum Index Density	(Maximum Index Density) - (TxDOT)
Plant #9	119.4	112.6	-6.80
McNary	110.8	110.0	-0.80
NW No Ag.	110.7	108.0	-2.70
Corpus Christi	111.7	105.6	-6.10
Beaumont	108.7	106.8	-1.90
Austin	109.1	102.7	-6.40
Houston	119.0	103.5	-15.50
Redd Road	116.1	109.0	-7.10
Horizon	115.1	109.1	-6.00
NW w/Ag.	115.4	113.2	-2.20
Acala	119.5	117.9	-1.60
NWTLE	124.1	106.9	-17.20
MP 53	115.9	101.2	-14.70

Bold values, e.g., **119.4**, indicate maximum value for each soil by compaction procedure shown.

Figure 8.2: Comparison of maximum dry densities (lb/ft³) from TxDOT (Tx-113-E) and Maximum Index Density (ASTM D-4253) procedures



8.2.2 Comparison between Results of TxDOT and Modified Proctor Tests

The previous two sections suggest that both the Modified Proctor and TxDOT procedures provide reasonable maximum dry densities compared to the Maximum Index Density. However, the Modified Proctor and TxDOT procedures each produce a different maximum dry density. The maximum dry densities obtained from the Modified Proctor and TxDOT procedures are shown for comparison in Table 8.5. The differences in maximum dry densities were computed and are also shown in Table 8.5. The ratio of the maximum dry density obtained in the TxDOT procedure to the Modified Proctor maximum density was computed for each soil. These ratios are presented in Figure 8.3 and grouped according to USCS soil type. The TxDOT procedure produced maximum dry densities greater than the Modified Proctor procedure for all soils, with the exception of the SM soil designated “MP 53.” This soil was from the El Paso area and contained a significant amount of caliche. Significant breakage of the caliche particles occurred in this soil during compaction testing. Considering all the soils tested, the maximum dry densities obtained by the TxDOT procedure exceeded those by the Modified Proctor procedure by averages of 4, 3, and 1 percent for the SP, SP-SM, and SM soils, respectively.

8.2.3 Comparison of Results of British Vibratory Hammer Test with Maximum Index Density, Modified Proctor, and TxDOT Tests

The study by Delphia (1998) recommended the British Vibratory Hammer procedure for determining the maximum dry density of cohesionless soils. In order to evaluate how the maximum densities obtained by the British Vibratory Hammer procedure compared with those from other tests that are more widely used in the United States, the maximum densities from the British Vibratory Hammer test were compared to those of the other tests examined in this study. The next three sections present these comparisons.

Table 8.5: Difference between maximum dry density (lb/ft³) from TxDOT (Tx-113-E) and Modified Proctor (ASTM D-1557) tests

Soil	TxDOT	Modified Proctor	(Modified Proctor) - (TxDOT)
Plant #9	119.4	116.5	-2.90
McNary	110.8	106.5	-4.30
NW No Ag.	110.7	106.3	-4.40
Corpus Christi	111.7	105.2	-6.50
Beaumont	108.7	104.8	-3.90
Austin	109.1	104.8	-4.30
Houston	119.0	113.2	-5.80
Redd Road	116.1	112.5	-3.60
Horizon	115.1	111.5	-3.60
NW w/Ag.	115.4	111.0	-4.40
Acala	119.5	118.3	-1.20
NWTLE	124.1	120.1	-4.00
MP 53	115.9	118.6	2.70

Bold values, e.g., **119.4**, indicate maximum value for each soil by compaction procedure shown.

Figure 8.3: Comparison of maximum dry density (lb/ft^3) from TxDOT (Tx-113-E) and Modified Proctor (ASTM D-1557) procedures

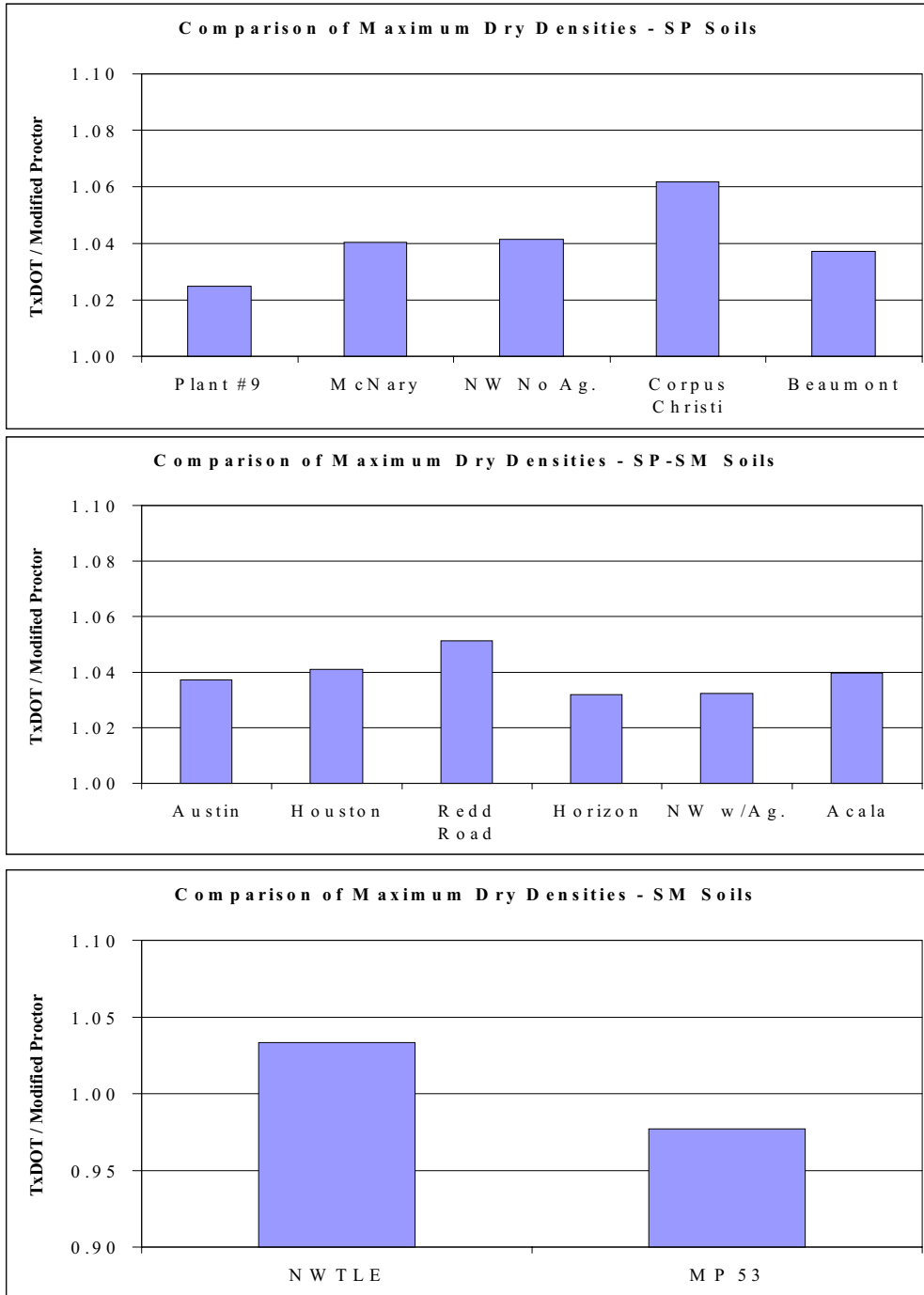

8.2.3.1 Comparison between Results of British Vibratory Hammer and Maximum Index Density Tests

The maximum dry densities obtained from the British Vibratory Hammer and Maximum Index Density procedures are shown for comparison in Table 8.6. The differences in maximum dry densities were also computed and are shown in this table. The ratio of the maximum dry density obtained by the British Vibratory Hammer test to the Maximum Index Density was computed for each of the six soils compared with the British Vibratory Hammer. These ratios are presented in Figures 8.4, 8.5, and 8.6. The British Vibratory Hammer test produced maximum dry densities greater than the Maximum Index Density test for all six soils tested. The maximum dry densities obtained by the British Vibratory Hammer procedure exceeded the Maximum Index Density by averages of 4, 5, and 10 percent for the SP, SP-SM, and SM soils, respectively.

8.2.3.2 Comparison between Results of British Vibratory Hammer and Modified Proctor Tests

The maximum dry densities obtained by the British Vibratory Hammer and Modified Proctor procedures are shown for comparison in Table 8.7. The differences in maximum dry densities were also computed and are shown in this table. The ratio of the maximum dry densities by the British Vibratory Hammer to the Modified Proctor maximum density was computed for each soil tested. These ratios are presented in Figure 8.5. The British Vibratory Hammer test produced maximum dry densities greater than the Modified Proctor tests for all of the SP and SP-SM soils tested, by averages of 4 and 3 percent, respectively. Only the SM soil had a higher density from the Modified Proctor procedure than the British Vibratory Hammer procedure, the two densities differing by about 1 percent.

Table 8.6: Difference between maximum dry density (lb/ft^3) from British Vibratory Hammer (BS-1377) and **Maximum Index Density (ASTM D-4253) tests**

Soil	BS-1377	ASTM D-4253	(ASTM D-4253) - (BS-1337)
Plant #9	117.4	112.6	-4.8
McNary	113.2	110.0	-3.2
NW No Ag.	113.4	108.0	-5.4
Redd Road	115.2	109.0	-6.2
Horizon	113.8	109.1	-4.7
NWTLE	117.5	106.9	-10.6

Bold values, e.g., **117.4**, indicate maximum value for each soil by compaction procedures shown

Figure 8.4: Comparison of maximum dry density (lb/ft³) from British Vibratory Hammer (BS-1377) to Maximum Index Density (ASTM D-4253)

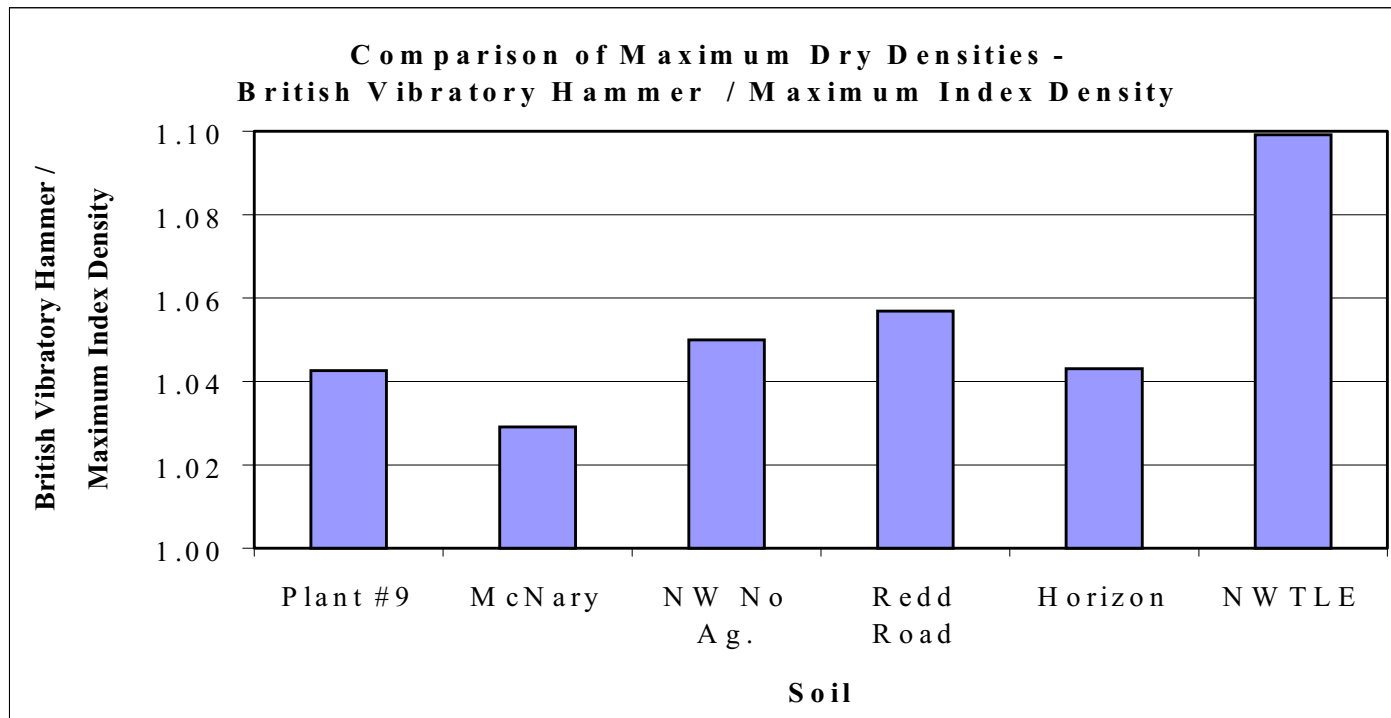

USCS Classification:

SP: Plant #9, McNary, & NW No Ag.

SP-SM: Redd Road & Horizon

SM: NWTLE

Figure 8.5: Comparison of maximum dry density (lb/ft^3) from British Vibratory Hammer (BS-1377) to Modified Proctor (ASTM D-1577)

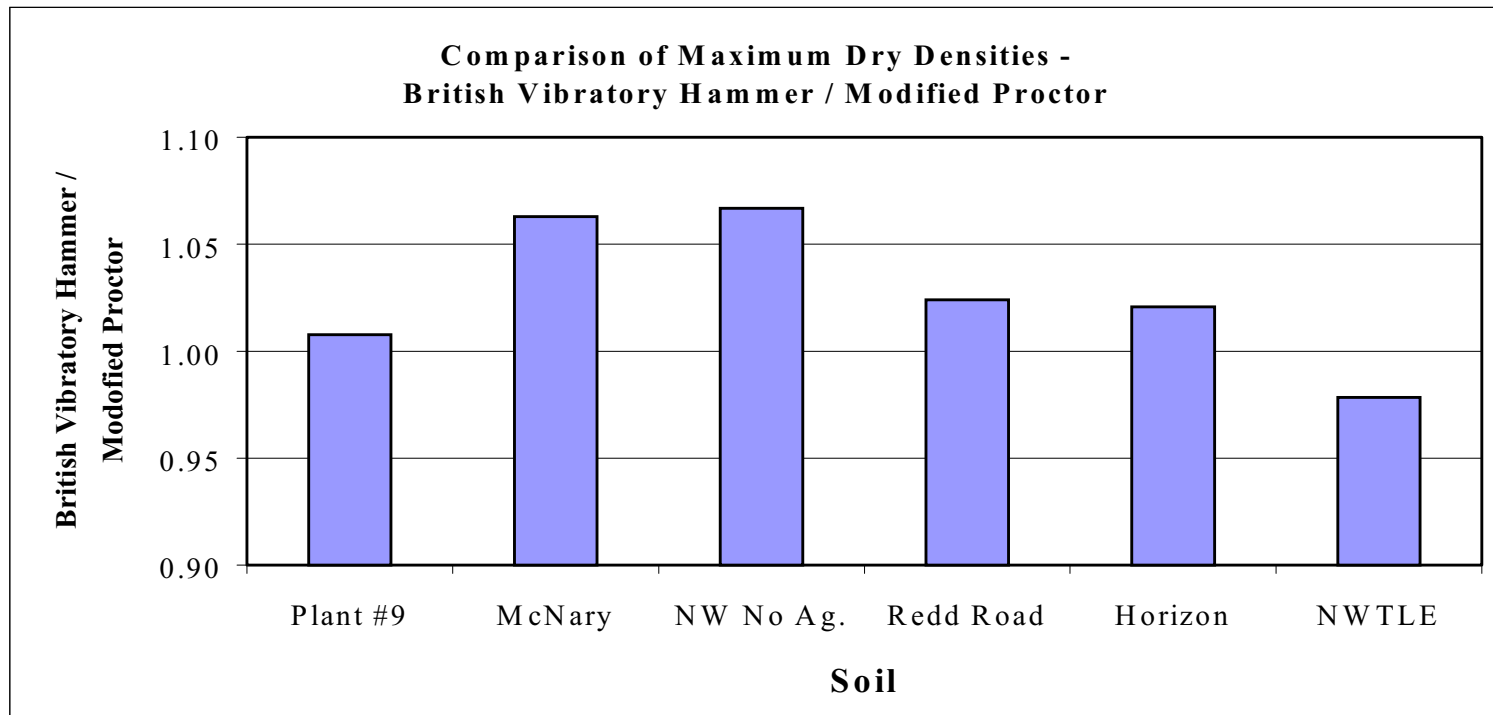

USCS Classification:

SP: Plant #9, McNary, & NW No Ag.

SP-SM: Redd Road & Horizon

SM: NWTLE

Figure 8.6: Comparison of maximum dry density (lb/ft³) from British Vibratory Hammer (BS-1377) to TxDOT (Tx-113-E) procedures

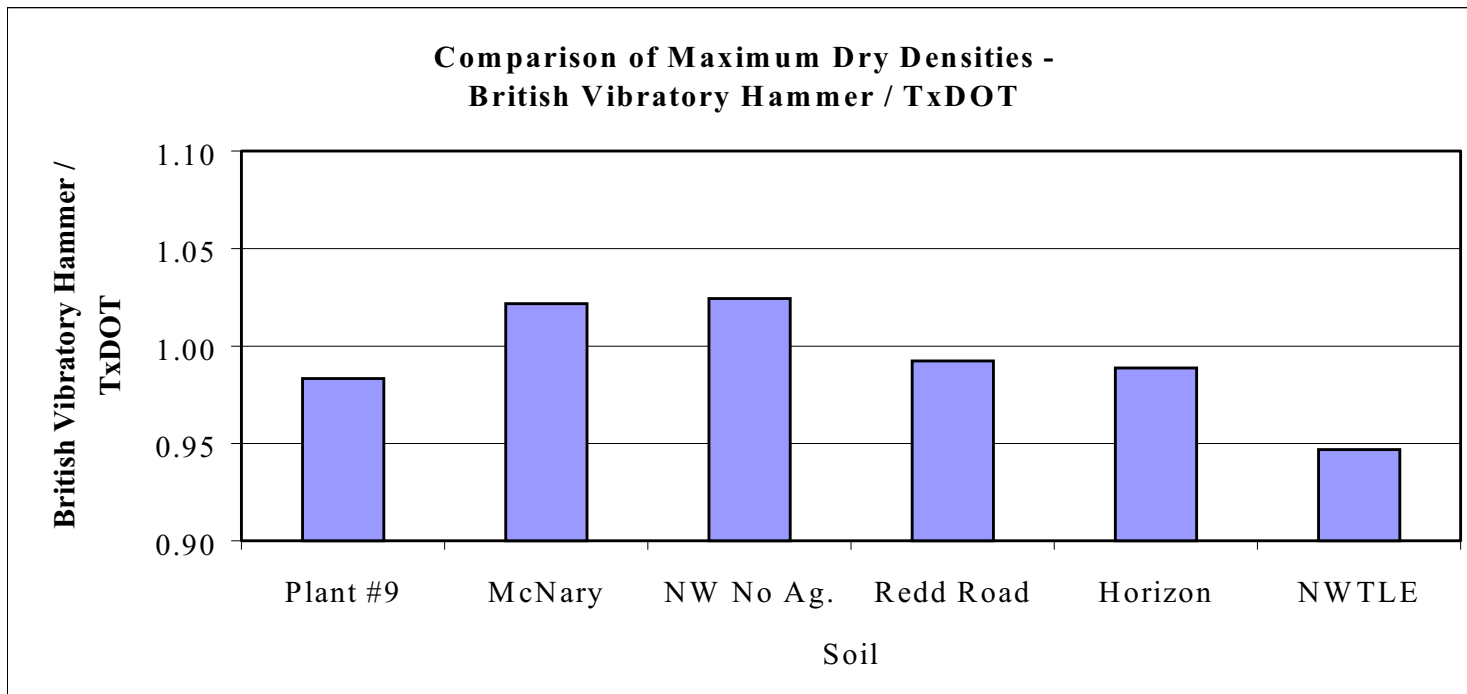

USCS Classification:

SP: Plant #9, McNary, & NW No Ag.
 SP-SM: Redd Road & Horizon
 SM: NWTLE

Table 8.7: Difference between maximum dry density (lb/ft^3) from British Vibratory Hammer (BS-1377) and Modified Proctor (ASTM D-1557) tests

Soil	British Vibratory Hammer	Modified Proctor	(Modified Proctor) - (British Vibratory Hammer)
Plant #9	117.4	116.5	-0.9
McNary	113.2	106.5	-6.7
NW No Ag.	113.4	106.3	-7.1
Redd Road	115.2	112.5	-2.7
Horizon	113.8	111.5	-2.3
NWTLE	117.5	120.1	2.6

Bold values, e.g., **117.4**, indicate maximum value for each soil by compaction procedures shown.

8.2.3.3 Comparison between Results of British Vibratory Hammer and TxDOT Tests

The maximum dry densities obtained from the British Vibratory Hammer and TxDOT procedures are shown for comparison in Table 8.8. The differences in maximum dry densities were also computed and are shown in this table. The ratio of the maximum dry density by the British Vibratory Hammer test to the TxDOT 113-E maximum density was computed for each soil. These ratios are presented in Figure 8.6. The TxDOT test produced maximum dry densities greater than the British Vibratory Hammer tests for the SM and SP-SM soils tested, by averages of 5 and 1 percent, respectively.

For two of the three SP soils tested, the British Vibratory Hammer produced maximum dry densities greater than the TxDOT procedure. The maximum dry density from the British Vibratory Hammer for these two SP soils was an average of 2 percent greater than the maximum density from the TxDOT procedure. The remaining SP soil had a maximum dry density by the British Vibratory Hammer procedure that was 2 percent less than the maximum dry density by the TxDOT procedure.

8.2.4 Factors that Influence the Compaction Test Results

The differences among the maximum dry densities obtained by the various procedures can be explained in part by differences in the type and amount of compactive energy imparted into the soil. The Modified Proctor and TxDOT procedures apply an impact type of compactive effort to the soil. The Maximum Index Density and British Vibratory Hammer procedures apply a vibratory compactive effort. The compacted dry density of a soil is determined by the interaction between the type (impact or vibratory) and amount of compactive energy imparted into the soil. Early work on soil compaction by R. R. Proctor (1933) indicated that increasing the compactive energy increased the dry density. In the next two sections, the compactive energy of each of the standard compaction tests employed in this study is examined and differences in compactive energy and the effect of these differences on maximum dry densities are discussed. Additional factors that affect the maximum dry density obtained by the various compaction procedures are discussed later in Section 8.2.4.3.

Table 8.8: Difference between maximum dry density (lb/ft³) from British Vibratory Hammer (BS-1377) and TxDOT (Tx-113-E) tests

Soil	BS-1377	Tx-113-E	(Tx-113-E) - (BS-1337)
Plant #9	117.4	119.4	2.0
McNary	113.2	110.8	-2.4
NW No Ag.	113.4	110.7	-2.7
Redd Road	115.2	116.1	0.9
Horizon	113.8	115.1	1.3
NWTLE	117.5	124.1	6.6

Bold values, e.g., **119.4**, indicate maximum value for each soil by compaction procedure shown.

8.2.4.1 Compactive Effort of Impact Compaction Procedures

The Modified Proctor and TxDOT compaction procedures both use the impact of a drop hammer to compact the soil. The compactive effort of these two procedures is calculated in terms of the mechanical energy applied per volume of soil compacted with the following equation:

$$E = \frac{[W] \times [e] \times [f_s] \times [t] \times [N_L]}{[V]} \quad (\text{Eq. 8.1})$$

where E is the compaction energy, N_B is the number of blows per layer, N_L is the number of layers, W is the weight of the hammer, H is the height of the drop, and V is the volume of the mold. The variables that control the compactive effort in the Modified Proctor and TxDOT compaction procedures are summarized in Table 8.9, along with the computed compaction energies. It can be seen that the compactive energy for the TxDOT procedure is about 63 percent greater than the compactive energy of the Modified Proctor procedure. The maximum dry densities obtained by the TxDOT procedure exceeded the Modified Proctor by averages of 4, 4, and 1 percent for the SP, SP-SM, and SM soils, respectively.

8.2.4.2 Compactive Effort of Vibratory Compaction Procedures

The ASTM Maximum Index Density and British Vibratory Hammer compaction procedures apply vibratory energy to the soil. An estimate of the compactive effort for these two procedures can be calculated by converting the electrical input to the compaction devices into an energy. The energy applied per volume of soil compacted is computed with the following equation:

$$E = \frac{[W] \times [e] \times [f_s] \times [t] \times [N_L]}{[V]} \quad (\text{Eq. 8.2})$$

where E is the compactive energy, W is the electrical input, e is the efficiency of the equipment, f_s is the electrical input imparted into the soil, t is the time of vibration, N_L is the

Table 8.9: Input variables and compactive effort of impact type compaction tests

Compaction Procedure	No. Blows per Layer	No. Layers	Hammer Weight	Drop Height	Volume of Mold	Compactive Effort
Modified Proctor	25	5	10 lb	1.5 ft	1/30 ft ³	56,250 (lb-ft/ft ³)
TxDOT	100	8	10 lb	1.5 ft	1/7.6 ft ³	91,673 (lb-ft/ft ³)

number of layers, and V is the volume of the mold. Quantities contributing to the energy as characterized by Eq. 8.2 are summarized for the Maximum Index Density and British Vibratory Hammer compaction procedures in Table 8.10. Values of 50 percent were assumed for the equipment efficiency and fraction of energy transmitted to the soil, based upon the recommendations of Head (1980). The computed compaction energies are also shown in Table 8.10. Table 8.10 indicates that the compactive energy of the British Vibratory Hammer procedure is over twice (approximately 131 percent greater than) the impact compactive energy of the Maximum Index Density procedure. This is believed to explain, at least partially, why the densities obtained by the British Vibratory Hammer procedure were much larger than those obtained by the ASTM Maximum Index Density procedure.

8.2.4.3 Effects of Surcharge Load on Vibratory Test Results

Another factor that may explain the differences in densities obtained from the British Vibratory Hammer and Maximum Index Density tests is the static surcharge load. The surcharge load applied to the soil in the British Vibratory Hammer and Maximum Index Density tests is approximately 3 psi and 2 psi, respectively. Felt (1958) indicated that for vibration times less than about 25 minutes, an increase in the surcharge load causes an increase in the dry density. This may also partially explain the higher densities obtained by the British Vibratory Hammer procedure compared to the Maximum Index Density procedure.

8.2.4.4 Other Factors that Affect the Maximum Density for Vibratory Methods

Factors such as the number of compacted layers, layer thickness, vibration time, surcharge pressure, and frequency of vibration all combine to affect the densities obtained by the British Vibratory Hammer and Maximum Index Density procedures. However, the combined effects on the densities obtained by these vibratory methods are not completely understood. Frossblad (1967) reported that these factors combined to apply greater pressures

Table 8.10: Input variables and compactive effort of vibratory type compaction tests

Compaction Procedure	Electrical Input	Efficiency of Equipment	Percent of Energy Imparted into Soil	Vibration Time of Each Layer	No. of Layers	Volume of Mold	Compactive Effort
Maximum Index Density	120 W	50 % ⁽¹⁾	50 % ⁽¹⁾	60 sec	3	1/10 ft ³	106,276 (lb-ft/ft ³)
British Vibratory Hammer	600 W	50 % ⁽¹⁾	50 % ⁽¹⁾	480 sec	1	1/8.7 ft ³	245,198 (lb-ft/ft ³)

(1) Assumed values

during compaction with a vibrating hammer procedure, like the British Vibratory Hammer procedure, than with a procedure similar to the ASTM Maximum Index Density procedure. The greater pressures during compaction with the British Vibratory Hammer procedure compared to the Maximum Index Density procedure may result in the higher densities obtained by the British Vibratory Hammer tests.

8.2.4.5 Effect of Soil Type on Differences between Vibratory and Impact Type Compacted Densities

Depending on the type of soil, either vibratory or impact type compaction may be more effective. Generally, cohesionless soils can be compacted more readily through vibratory methods while cohesive soils are more easily compacted with impact type compaction. Poulos and Head (1973) report that the vibratory compaction used in the Maximum Index Density procedure generally produces higher densities than the impact compaction of the Modified Proctor procedure for clean SP and SW sands. This was also observed for the SP soils tested in this study. However, the Maximum Index Density procedure produced lower densities with the SP-SM and SM soils. These findings are consistent with the work of Townsend (1973). Townsend reported that increasing the percent fines and the plasticity of the fines caused a decrease in the dry densities obtained by vibratory methods, while the density in impact compaction tests increased with an increase in the fine content of the soil. Correspondingly, larger dry densities were obtained for the SP-SM and SM soils by the Modified Proctor procedure compared to the Maximum Index Density procedure.

8.2.4.6 Summary of Factors that Influence the Compaction Test Results

Differences among the maximum dry densities obtained by various procedures are influenced by numerous factors. Factors include surcharge load, number of compacted layers, layer thickness, vibration time, frequency of vibration, and soil type. The principal explanation for the differences in the results of the various compaction tests is the differences in the type and amount of compactive energy imparted into the soil. The type (impact or vibratory) and amount of compaction energy imparted into a soil controls the maximum dry

density obtained by a given compaction procedure. Although the interaction between type and amount of compaction energy is not completely understood, it is evident that increasing the compactive effort by either vibratory or impact methods causes an increase in the maximum dry densities.

8.3 GENERAL CHARACTERISTICS OF THE MOISTURE-DENSITY CURVES

None of the compaction moisture-density curves developed for the SP soils by the Modified Proctor, TxDOT, and British Vibratory Hammer procedures exhibited a well-defined peak. The moisture-density curves of the SP soils were relatively flat over a broad range of moisture contents. Some multiple “peaks” were observed in the relatively flat moisture-density curves, but these apparent peaks can be attributed to statistical variations from test to test.

The lack of well-defined peaks in the moisture-density curves for SP soils is consistent with the observations by Monahan (1986). Waidelich (1990), Head (1980), and Bros and Orzesyna (1979) also indicated that uniform, fine sands typically produce flat moisture-density curves over a wide range of moisture contents. Numerous authors (Cornforth 1973; Poulos and Head 1973; Frossblad 1967; Schroeder 1984; and Roston 1976) have stated that the moisture-density curves of uniform, fine sands are typically S-shaped, with maximum dry densities and optimum moisture contents occurring near 0 percent and 100 percent saturation. An idealized moisture-density curve for clean sands is illustrated in Figure 8.7. The S-shaped moisture-density curves are believed to occur because of surface tension that develops in partly saturated soil. This surface tension increases the resistance of the soil to compaction and reduces the dry density; therefore, densities are higher when the soil is either completely dry or nearly saturated (Schroeder 1984). This effect is generally described as “bulking” of the sand.

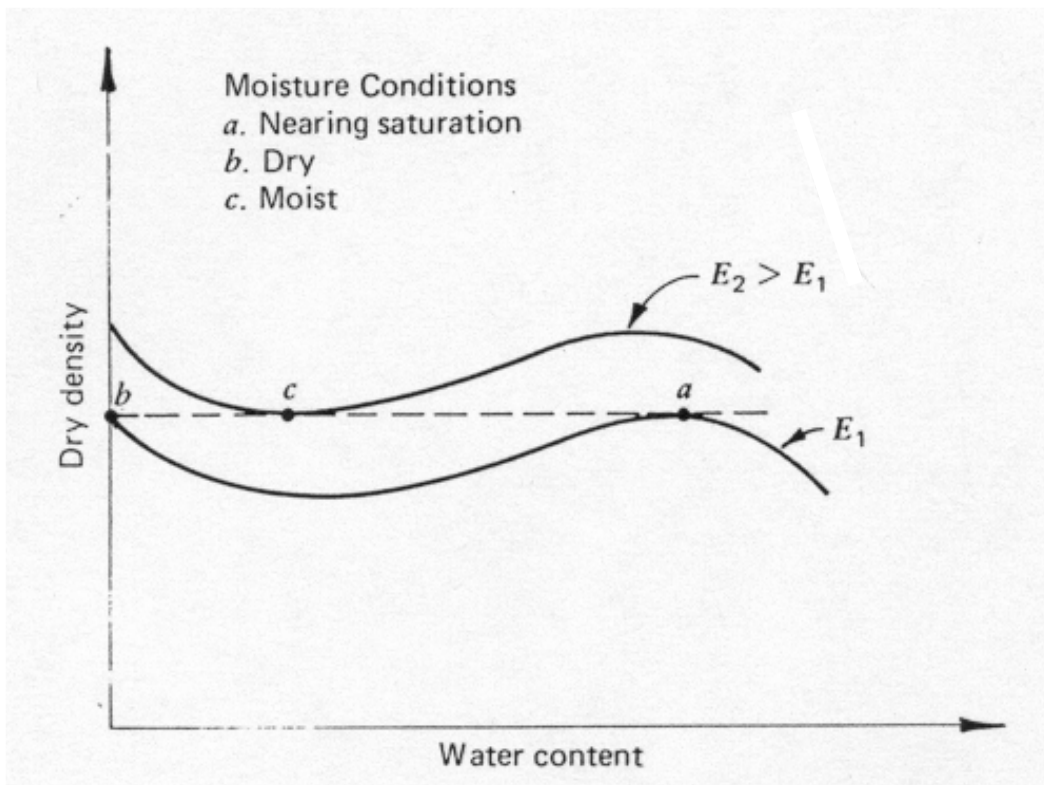

Figure 8.7: Idealized moisture-density curve for clean sands (Schroeder 1980)

The SM soils all produced moisture-density curves with single, well-defined peaks with corresponding maximum dry densities and optimum moisture contents. S-shaped moisture-density curves did not develop for any of the SM soils tested. The moisture-density curves of the SM soils tested are similar in shape to moisture-density curves of cohesive soils (Shroeder 1984; Das 1990).

The moisture-density curves for the SP-SM soils compacted by the Modified Proctor, TxDOT, and British Vibratory Hammer tests varied in shape. Some curves had a single, well-defined peak while others were S-shaped like the curves observed for the SP soils.

8.4 OPTIMUM MOISTURE CONTENTS

The optimum moisture contents that were determined using the Modified Proctor and TxDOT compaction procedures are summarized in Table 8.11. Optimum moisture contents for the six soils compacted using the British Vibratory Hammer procedure are summarized along with the results from the Modified Proctor and TxDOT procedures in Table 8.12.

It is generally expected that an increase in the compactive effort should increase the density and decrease optimum moisture content of a soil (Ray and Chapman 1954; Williamson and Walsh 1969; Holtz 1973). The compactive effort of the TxDOT procedure is significantly larger than the effort of the Modified Proctor procedure; therefore, the optimum moisture content obtained by the TxDOT procedure was expected to be lower than that obtained by the Modified Proctor procedure. A comparison of the optimum moisture contents obtained by the Modified Proctor and TxDOT procedures for the various soil types is presented in Figure 8.8. This figure indicates that the optimum moisture content of the soils tested did not always decrease with increased compactive effort.

Table 8.11: Optimum moisture content (%) from Modified Proctor (ASTM D-1557) and TxDOT (Tx-113-E) procedures

Soil	Modified Proctor	TxDOT
Plant #9	5.1	9.5
McNary	0.5	1.4
NW No Ag.	9.8	1.5
Ft. Worth	8.2	NA
Corpus Christi	2.0	3.2
Beaumont	0.1	1.0
Austin	9.9	0.7
Houston	8.3	8.7
Redd Road	9.2	10.1
Horizon	5.4	11.4
NW w/Ag.	10.0	10.7
Acala	9.3	9.1
NWTLE	12.0	11.2
MP 53	11.6	14.5

Table 8.12: Optimum moisture content (%) from Modified Proctor (ASTM D-1557), TxDOT (Tx-113-E), and British Vibratory Hammer (BS-1377)

Soil	Modified Proctor	TxDOT	British Vibratory Hammer
Plant #9	5.1	9.5	8.7
McNary	0.5	1.4	9.3
NW No Ag.	9.8	1.5	9.1
Redd Road	9.2	10.1	8.6
Horizon	5.4	11.4	11.8
NWTLE	12.0	11.2	13.1

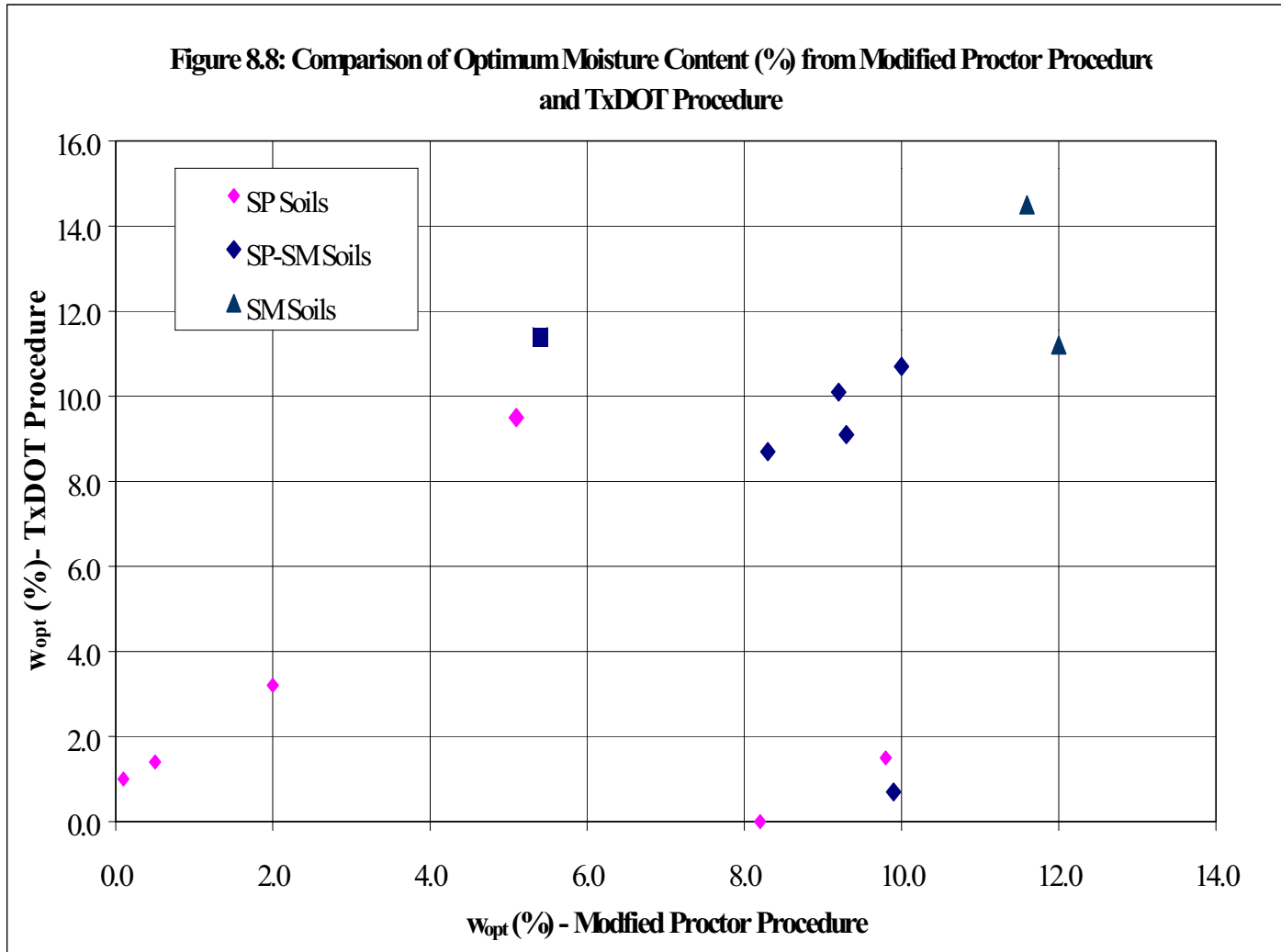

Figure 8.8 Comparison of Optimum Moisture Content (%) from Modified Proctor Procedure and TxDOT Procedure

8.5 VARIATIONS OF DENSITY IN MODIFIED PROCTOR COMPACTION TESTS

The maximum dry densities obtained using the Modified Proctor procedures were lower than the maximum dry densities obtained using the TxDOT Tx-113-E compaction procedures. One reason for the differences was the larger compactive effort used in the TxDOT test. Another reason for the lower dry densities obtained using the Modified Proctor procedure is thought to be the effects of “fluffing” of the soil near the surface of each compacted lift. The neoprene pad utilized in the TxDOT procedure acts to confine the soil during compaction and reduces the potential for “fluffing” of the soil near the surface being compacted. This confinement is not present during Modified Proctor compaction. Poulos (1988) indicated that sands near the surface of a compacted fill often have low dry densities because of a lack of confinement. To examine how the effect of fluffing of the soil near the surface affects the density reported for the Modified Proctor procedure, a special compaction mold was fabricated and additional tests were performed.

8.5.1 Split-Mold Compaction Test Equipment and Procedure

A special, two-part compaction mold was fabricated from 4-inch diameter molds like the ones described in Section 3.2 of Chapter 3. The special mold was constructed by splitting two 4-inch diameter molds horizontally into approximately two equal halves and then machining the two halves to mate into a single mold. Two molds were used to construct the single, special mold because of losses in height due to splitting and machining the molds. The complete, special mold has the same volume as the standard mold (1/30 ft³) and is illustrated in Figure 8.9.

A series of specimens was compacted into the special split mold using the Modified Proctor procedure described in Chapter 3. Once each sample was compacted, the density was determined based on the soil in the entire mold as prescribed by the Modified Proctor procedure. Then, the soil in the upper half of the mold was removed along with the upper half of the mold. Care was taken to ensure that the soil in the bottom half of the mold was

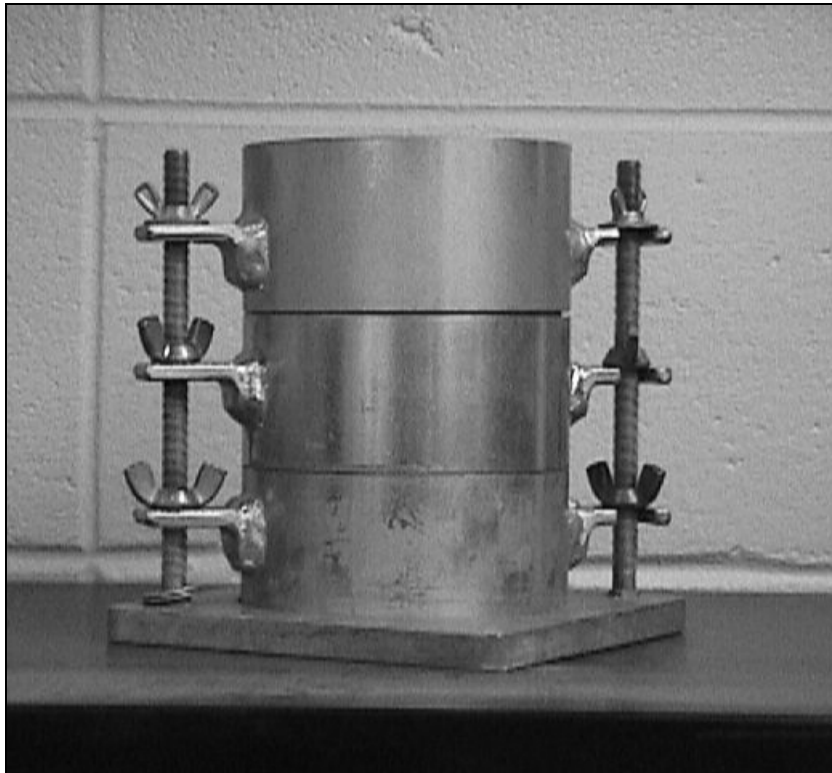

Figure 8.9: Fully assembled special 4-inch diameter split-mold

not disturbed during this process. The weight of the soil in the bottom half of the mold was measured, along with the volume of the bottom half of the mold. These measurements were then used to compute the density of the soil in the bottom half of the mold. The weight and volume of soil in the top half of the mold were then computed by subtracting the weight and volume of soil in the bottom half of the mold from the total weight and volume (1/30 ft³). The weight and volume of soil in the top half of the mold were then used to compute the density of the soil in the top half of the mold.

8.5.2 Modified Proctor Test Results for Special Split Mold

Modified Proctor compaction tests were performed using the special split mold to compact specimens of Beaumont (SP), Houston (SP-SM), and NWTLE (SM) soils. These three soils were selected because they were soils that exhibited significant “fluffing” at the surface during the Modified Proctor compaction tests. Complete moisture-density relationships were obtained and plotted based on the densities for the top half, bottom half, and entire mold. These relationships are presented in Figures 8.10, 8.11, and 8.12 for the Beaumont, Houston, and NWTLE soils, respectively. The maximum densities corresponding to the peak of each compaction curve are summarized in Table 8.13. The corresponding optimum moisture contents are summarized in Table 8.14.

8.5.3 Discussion of Results of Special Modified Proctor Tests with Split Mold

The maximum dry density of the soil in the top half of the mold was less than the maximum dry density of the soil in the bottom half of the mold for the Beaumont (SP) and Houston (SP-SM) soils by amounts of 3.7 and 1.1 percent, respectively. In contrast, for the NWTLE (SM) soil the moisture-density curves obtained for the top half of the mold and bottom half of the mold were nearly identical. For this soil, the maximum dry density of the soil in the top half of the mold was actually 0.4 percent larger than the maximum dry density of the soil in the bottom half of the mold.

Figure 8.10: Moisture-density curve of Beaumont soil (SP) from special split-mold Modified Proctor tests

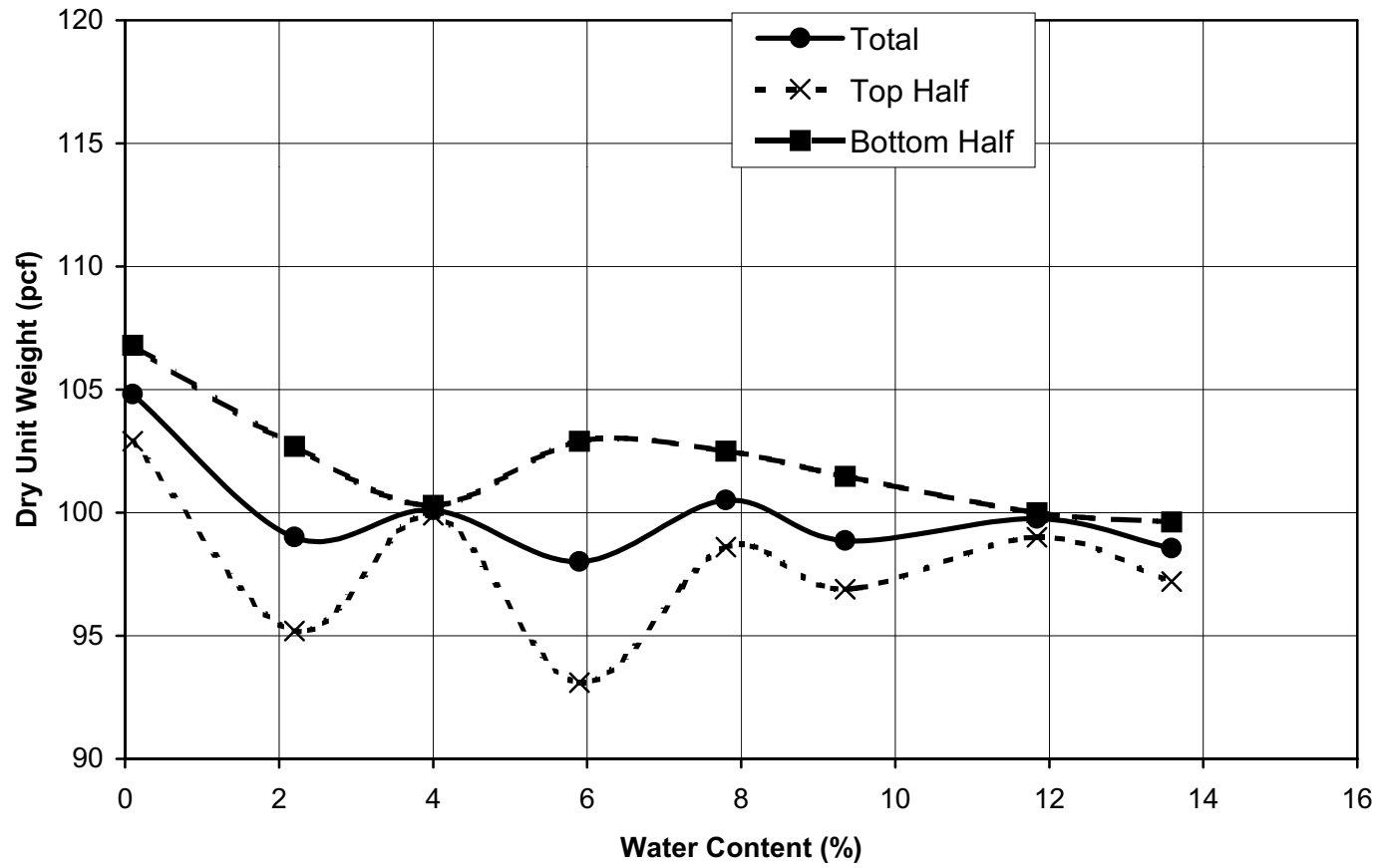

Figure 8.11: Moisture-density curve of Houston soil (SP-SM) from special split-mold Modified Proctor tests

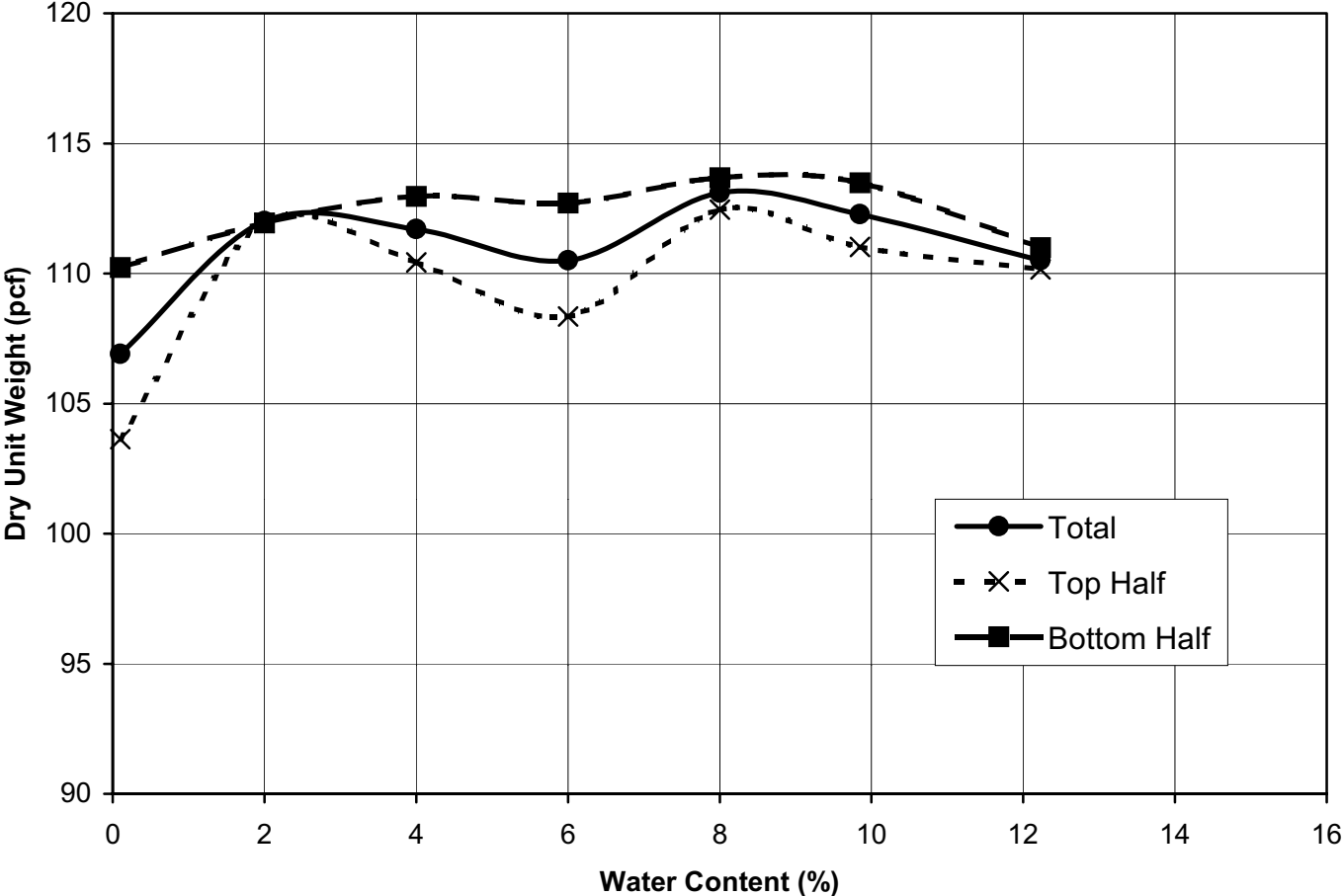

Figure 8.12: Moisture-density curve of NWTLE soil (SM) from special split-mold Modified Proctor tests

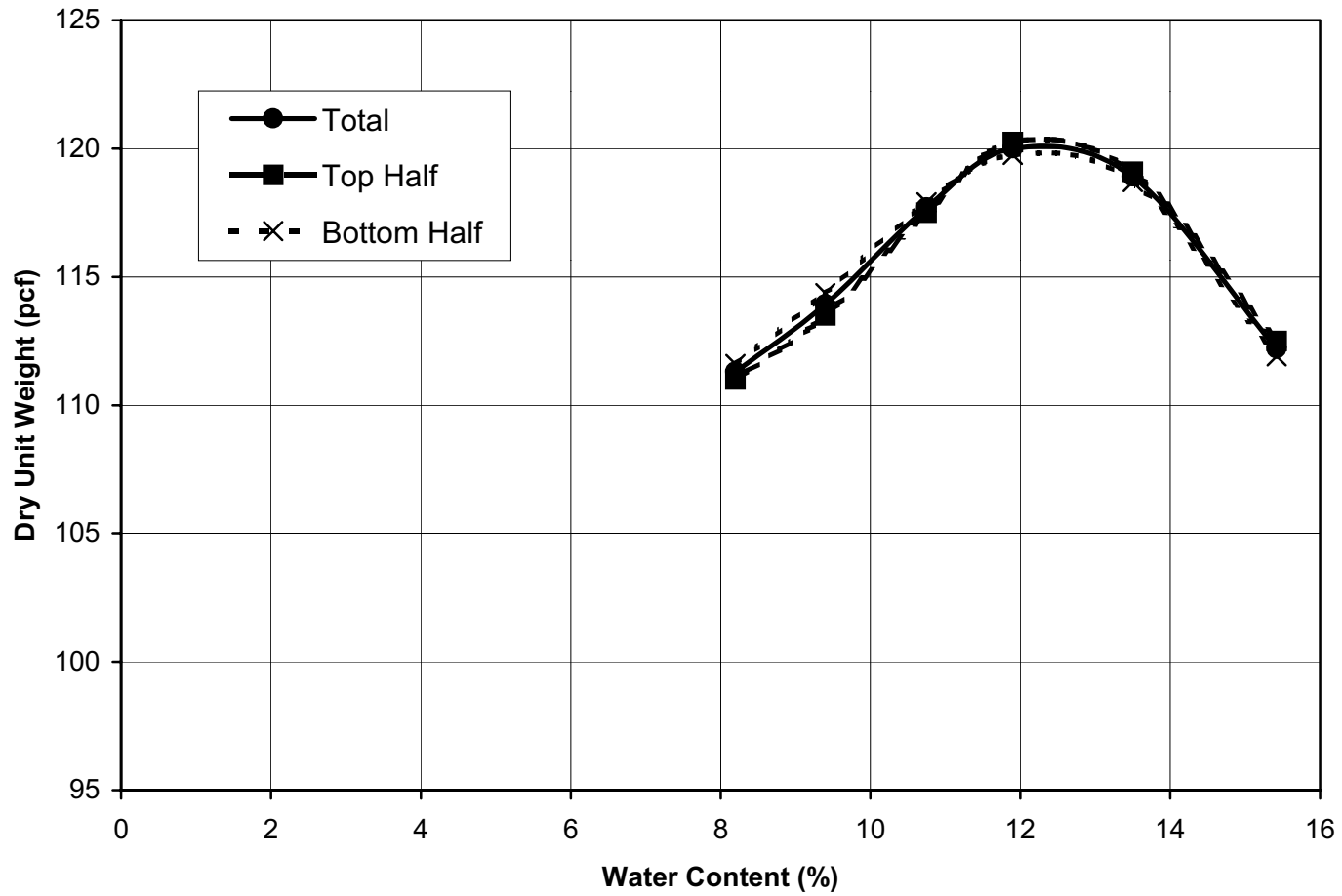

Table 8.13: Maximum dry density from special split-mold Modified Proctor compaction tests

Soil	Total Maximum Dry Density, lb/ft ³	Maximum Dry Density of Top Half, lb/ft ³	Maximum Dry Density of Bottom Half, lb/ft ³
Beaumont	104.8	102.9	106.8
Houston	113.2	112.5	113.7
NWTLE	120.1	120.3	119.8

Table 8.14: Optimum moisture content from special split-mold Modified Proctor compaction tests

Soil	Total Optimum Moisture Content, %	Optimum Moisture Content of Top Half, %	Optimum Moisture Content of Bottom Half, %
Beaumont	0.1	0.1	0.1
Houston	8.3	8.2	8.8
NWTLE	12.0	12.0	12.0

“Fluffing” of the soil near the surface during compaction of the Beaumont and Houston soils most likely caused the lower densities in the top half of the special mold. The maximum dry densities for the soil in the bottom half of the mold were compared with the maximum dry densities obtained using the Maximum Index Density in Table 8.15. This comparison was made to determine if “fluffing” of the soil near the surface may have resulted in the Modified Proctor procedure producing lower densities than the Maximum Index Density procedure. The densities in the bottom half of the mold were all equal to or exceeded the densities determined by the Maximum Index Density tests. These results indicate that the compacted density of the SP and SP-SM soils may be greater at depths where enough confinement is present to lessen the effects of “fluffing.” Less “fluffing” of the NWTLE (SM) soil occurred during compaction. The NWTLE soil had a moisture-density curve more typical of a cohesive soil than the Beaumont (SP) and Houston (SP-SM) soils. Consequently, the effects of “fluffing” were minimized during compaction and there was less variation in maximum dry density between the top and bottom half of the mold. The results of this test indicate that the variation in density of a compacted soil decreases with additional fines content. These tests also indicate that except for the near-surface effects observed for SP and SP-SM soils, the Modified Proctor procedure may always result in a density at least equal to that measured in the Maximum Index Density procedure.

8.6 PARTICLE BREAKAGE

Breakage of particles during the Modified Proctor and TxDOT impact compaction tests was investigated by comparing the grain size distribution curves for each soil before and after compaction. Inspection of the grain size curves before and after compaction indicates that very little particle breakage appears to have occurred. The only indication of particle breakage was a measurable increase in the weight of soil passing the No. 200 sieve before and after compaction. The percent by weight passing the No. 200 sieve before and after compaction, as well as the increase in percent passing, is presented in Table 8.16 and Figure 8.13 for each soil. The increases in the percent passing the No. 200 sieve for each

Table 8.15: Comparison of the maximum dry densities from the special split-mold Modified Proctor procedure with the maximum dry densities obtained by the Maximum Index Density Procedure

Soil	Special Modified Proctor (Entire Mold), lb/ft ³	Special Modified Proctor (Bottom Half of Mold), lb/ft ³	Maximum Index Density, lb/ft ³
Beaumont	104.8	106.8	106.8
Houston	113.2	113.7	103.5
NWTLE	120.1	119.8	106.9

Table 8.16: Percent passing the No. 200 sieve before and after Modified Proctor and TxDOT compaction tests

Soil	Initial % Passing No. 200 Sieve	Final % Passing No. 200 Sieve After Modified Proctor	Final % Passing No. 200 Sieve After TxDOT	USCS Classification
Plant #9	2.0	3.2	2.8	SP
McNary	4.0	3.9	5.0	SP
NW No Ag.	1.8	3.6	2.7	SP
Ft. Worth	0.4	0.5	NA	SP
Corpus Christi	0.2	0.9	1.5	SP
Beaumont	1.4	2.1	1.4	SP
Austin	8.4	9.1	9.4	SP-SM
Houston	10.8	12.5	12.3	SP-SM
Redd Road	9.3	11.5	11.2	SP-SM
Horizon	7.9	7.9	10.6	SP-SM
NW w/Ag.	8.2	9.3	8.2	SP-SM
Acala	6.1	8.7	8.1	SP-SM
NWTLE	24.1	28.0	27.2	SM
MP 53	24.9	33.5	32.1	SM

Figure 8.13: Percent Fines (Passing No. 200 Sieve) Before and After Modified Proctor and TxDOT Compaction Tests

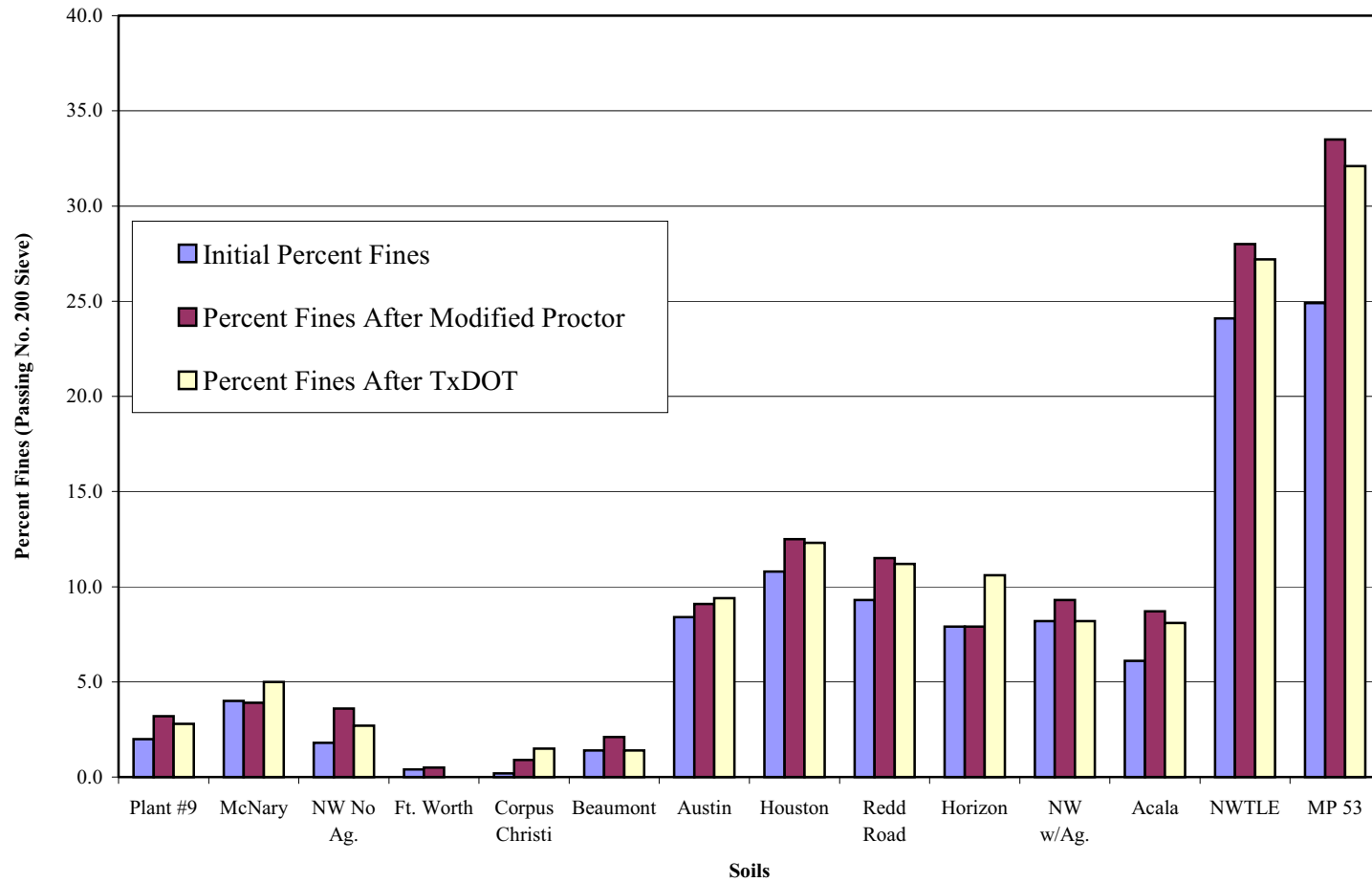

Table 8.17: Average increase in percent passing the No. 200 sieve after Modified Proctor and TxDOT compaction tests

Soil	Modified Proctor	TxDOT
SP	0.7	0.8
SP-SM	1.3	1.5
SM	6.3	5.2

compaction procedure are summarized in Table 8.17 as average values for each soil classification (SP, SP-SM, and SM). The grain size distribution curves before and after compaction for the SP and SP-SM soils indicate that particle breakage was not significant. The particles for these soils consisted primarily of weathered quartz, which is a hard mineral grain not susceptible to significant breakage. The average increase in percent passing the No. 200 sieve after Modified Proctor compaction was 0.7 and 1.3 percent for the SP and SP-SM soils tested, respectively. The average increase in percent passing the No. 200 sieve after TxDOT compaction tests was 0.8 and 1.5 percent for the SP and SP-SM soil tested, respectively. Although the observed particle breakage for the SP and SP-SM soils for this research was not significant, sands with weathered grains may experience more significant particle breakage. For example, Bros and Orzesyna (1979) performed Proctor compaction tests on sands and observed significant particle breakage for unweathered, angular SP soils. They indicated that weathered particles tend to be better rounded and polished; therefore, less particle breakage occurs.

The average increases in percent passing the No. 200 sieve for the SM soils were 6.3 and 5.2 for the Modified Proctor and TxDOT compaction tests, respectively. Although both SM soils tested experienced significant particle breakage, the soil designated MP 53 was exceptionally friable. This soil contained caliche, which was easily crushed during compaction, and is not representative of most sands. Sands that contain softer or weakly

cemented particles, such as the caliche in the MP 53 soil, may experience significant particle breakdown during impact compaction tests.

8.7 INFLUENCE OF SOIL GRADATION ON MOISTURE-DENSITY RELATIONSHIPS

Grain size distribution curves were examined to determine how gradation influenced the compaction moisture-density characteristics for the soils tested. Grain size distribution for cohesionless soils is often considered to be a primary factor affecting their maximum dry density (Youd 1973; Lacroix and Horn 1973; Burmister 1948). To determine if grain size distribution had a significant effect on the maximum dry densities of the soils tested in this study, the coefficient of uniformity (C_u), coefficient of curvature (C_c), percent fines, and percent fine sand were calculated and examined.

8.7.1 Influence of C_u and C_c

The coefficients of uniformity (C_u) and curvature (C_c) are both used to classify soils in the USCS. The coefficient of uniformity (C_u) is defined as:

$$C_u = \frac{D_{60}}{D_{10}} \quad (\text{Eq. 8.3})$$

where D_{60} and D_{10} are the grain sizes for which 60 and 10 percent, respectively, of the particles, by weight, are finer. The coefficient of curvature (C_c) is defined as:

$$C_c = \frac{D_{30}^2}{D_{60} \times D_{10}} \quad (\text{Eq. 8.4})$$

where D_{30} is the grain size for which 30 percent of the particles by weight, are finer.

The maximum dry densities obtained by the Maximum Index Density, Modified Proctor, TxDOT, and British Vibratory Hammer tests are plotted versus C_u and C_c in Figures 8.14, 8.15, 8.16, and 8.17, respectively. These figures indicate that there is no definitive relationship between C_u or C_c and the maximum dry densities obtained by the various compaction procedures for the soils tested. The results are also consistent with

Figure 8.14 Comparison of C_u and C_c with the maximum dry densities (lb/ft^3) from the Maximum Index Density procedure

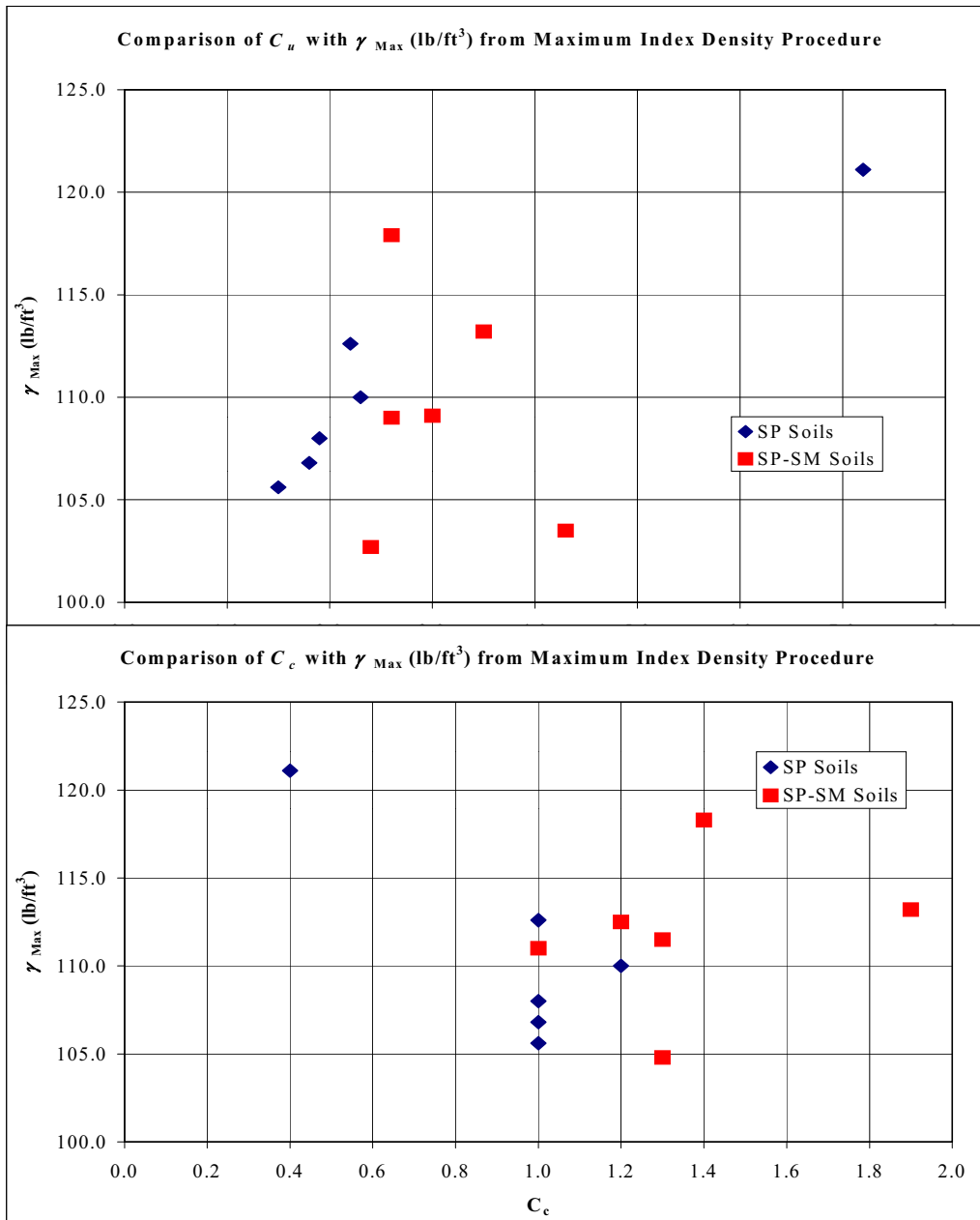

Figure 8.15: Comparison of C_u and C_c with the maximum dry densities (lb/ft^3) from the Modified Proctor procedure

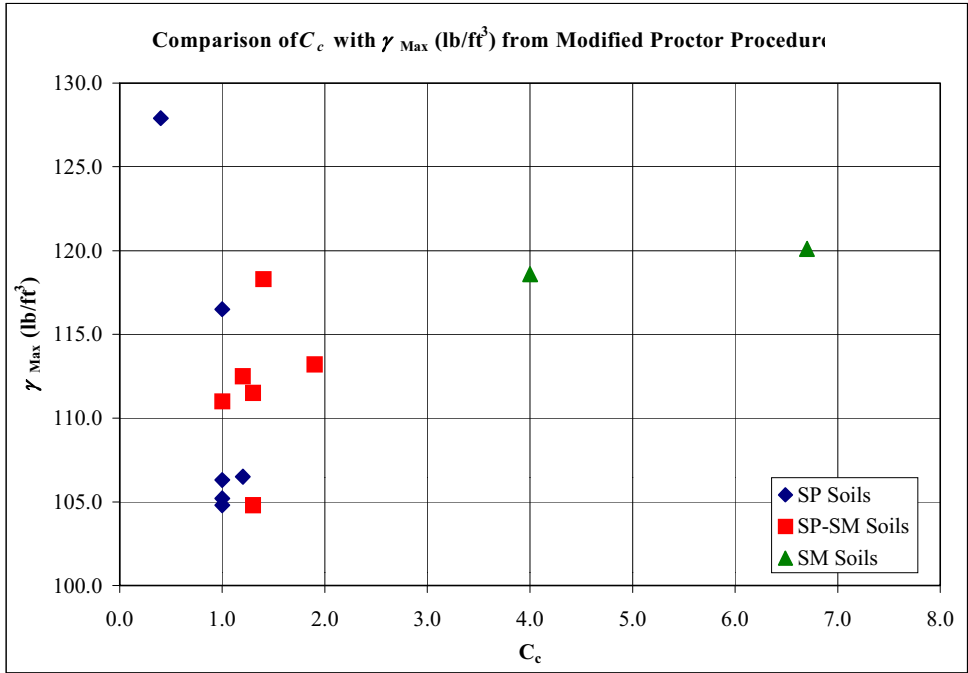
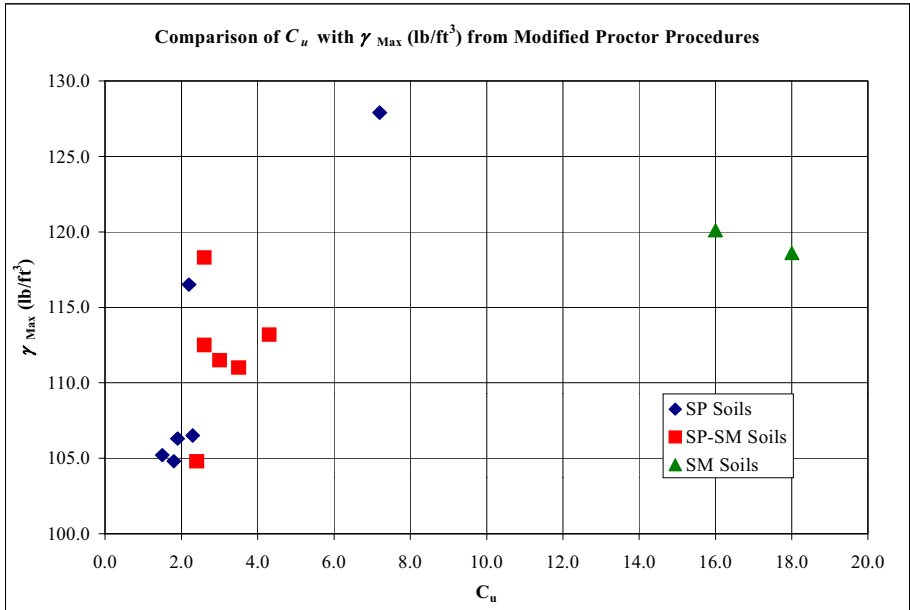

Figure 8.16: Comparison of C_u and C_c with the maximum dry densities (lb/ft^3) from the TxDOT procedure

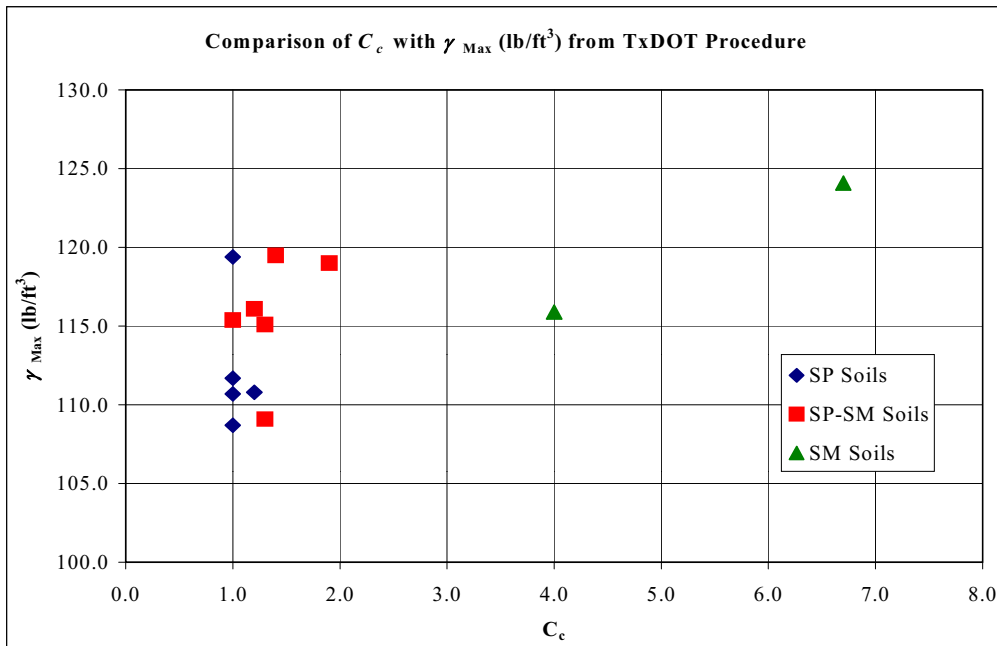
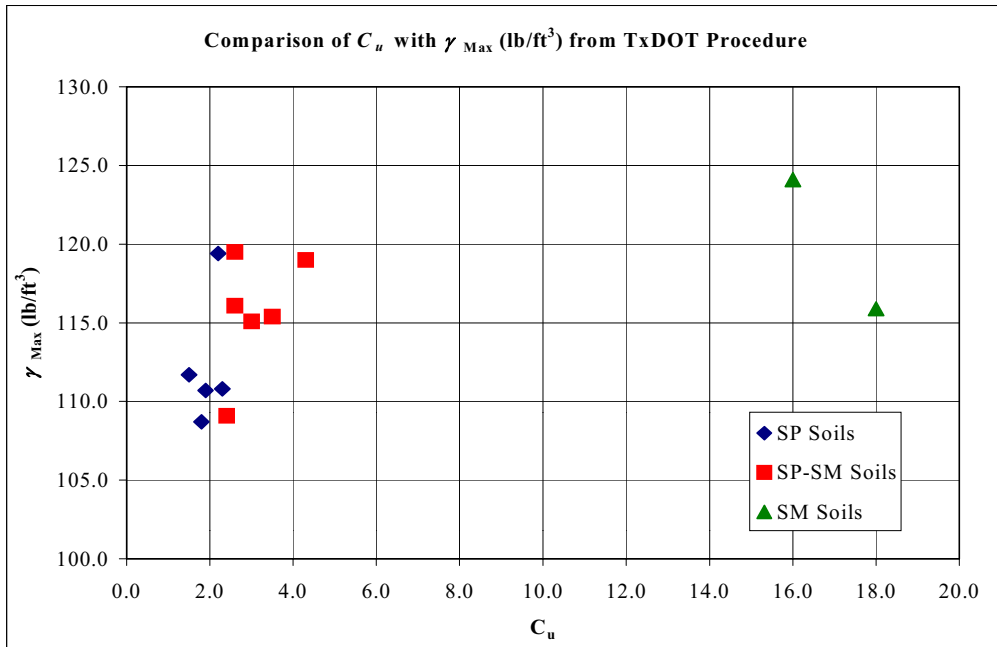
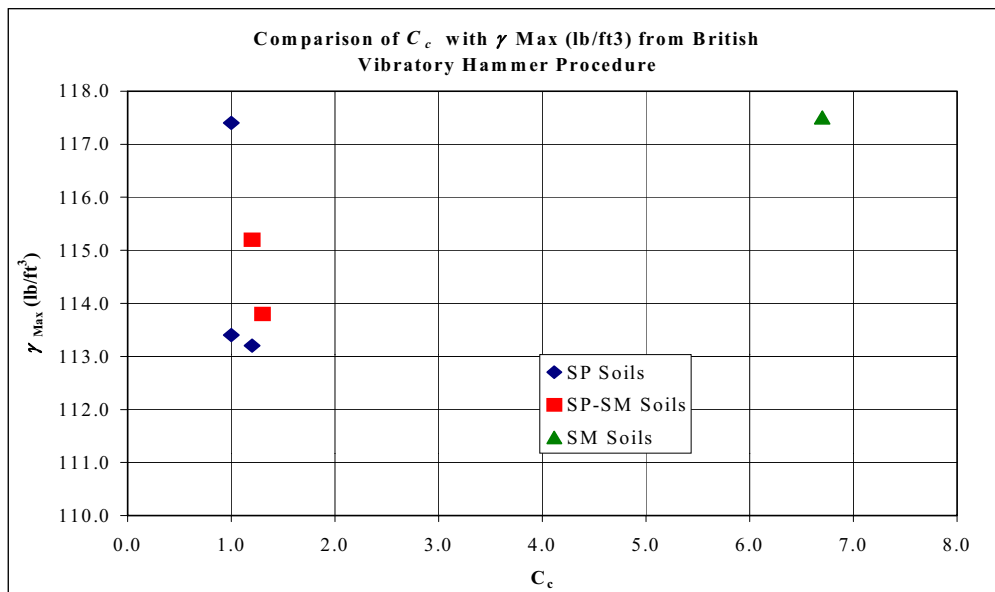
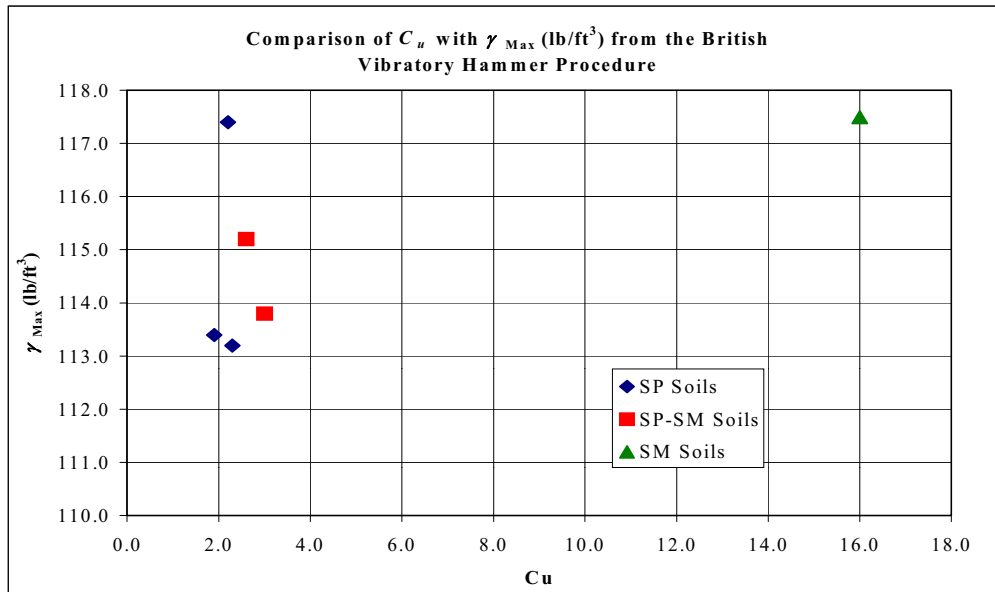

Figure 8.17: Comparison of C_u and C_c with the maximum dry densities (lb/ft^3) from the British Vibratory Hammer procedure



Poulos (1988), who indicated that sands with similar values of C_u and C_c might have a 4–5 lb/ft³ difference in maximum dry densities. Such variations in density exist because of different particle shapes and ranges in particle size, which can significantly impact the maximum density (Youd 1972; Holubec and d’Appolonia 1973).

8.7.2 Influence of Percent Fines

The percent fines were also examined to determine if there was a relationship between percent fines and the maximum dry density. The percent fines is defined as the percent by weight of particles that pass the No. 200 Sieve (0.075 mm opening). The percent fines for the soils tested are summarized in Figure 8.18. The percent fines shown represent the percentage before compaction. The maximum dry densities are plotted as a function of the percent fines in Figures 8.19, 8.20, 8.21, and 8.22 for the Maximum Index Density, Modified Proctor, TxDOT, and British Vibratory Hammer tests. No relationship was observed between the percent fines and the maximum dry densities for the various compaction procedures. One reason for the lack of a relationship may be that in addition to the amount of finer particles, the density of the soil is dependent upon the plasticity of the fine particles (Townsend 1973).

8.7.3 Influence of Percentage of Fine Sand

The percentage of fine sand was examined to determine if there was a relationship with the maximum dry density. Fine sand is defined as sand that passes the No. 40 sieve and is retained on the No. 200 Sieve (from 0.425 to 0.075 mm in size). The percent fine sand in the soils tested is summarized in Figure 8.23. The maximum dry densities are plotted as a function of the percent fine sand in Figures 8.24, 8.25, 8.26, and 8.27 for the Maximum Index Density, Modified Proctor, TxDOT, and British Vibratory Hammer tests, respectively. Additionally, these plots show a trend line based on linear regression and the correlation coefficient of each line. The correlation coefficients between the percent fine sand and the

Figure 8.18: Percent Fines (Passing No. 200 Sieve) of All Soils Tested

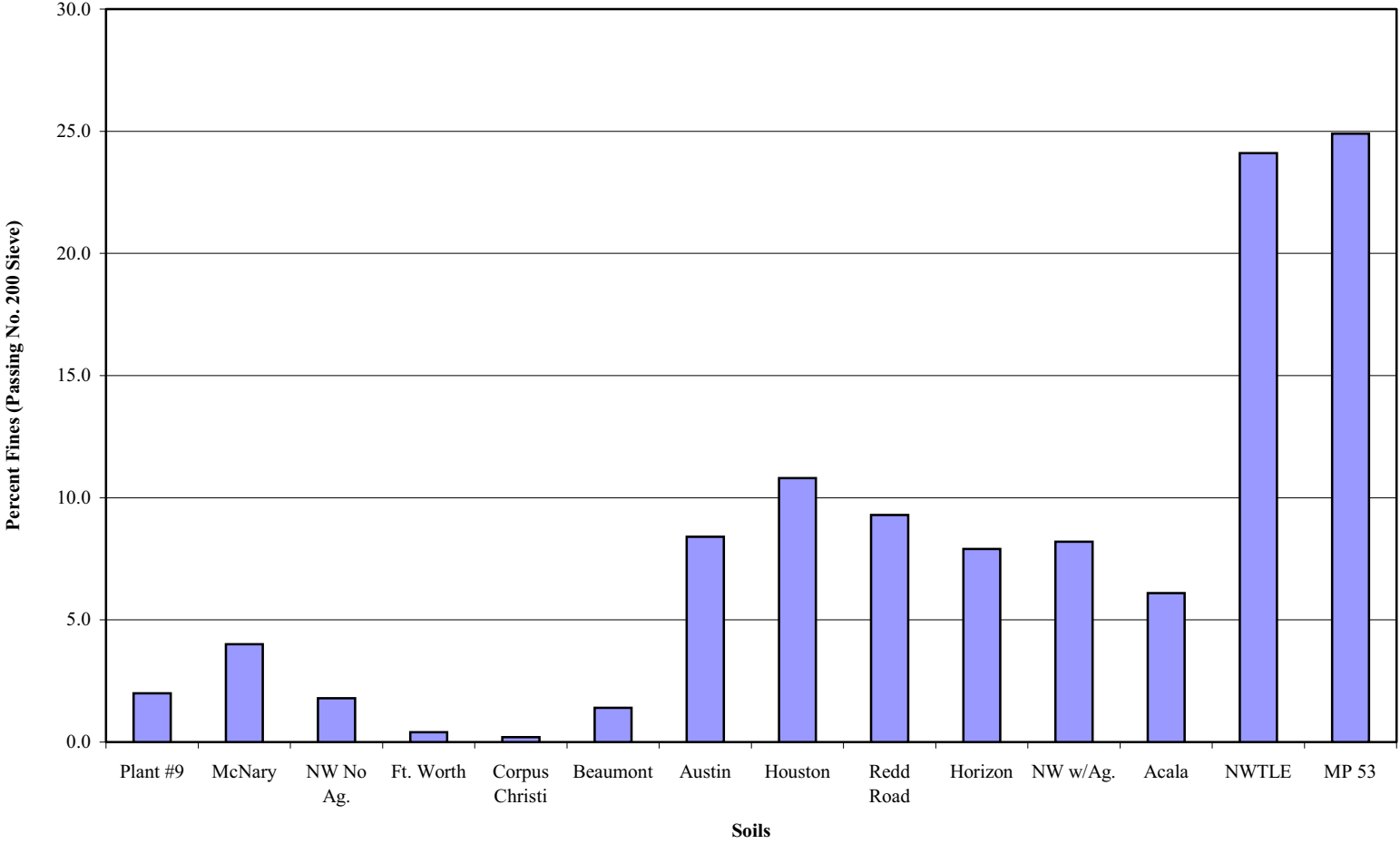

Figure 8.19: Relationship between Maximum Dry Density determined by ASTM D-4253 Maximum Index Density Procedure and the Percent Passing the No. 200 Sieve

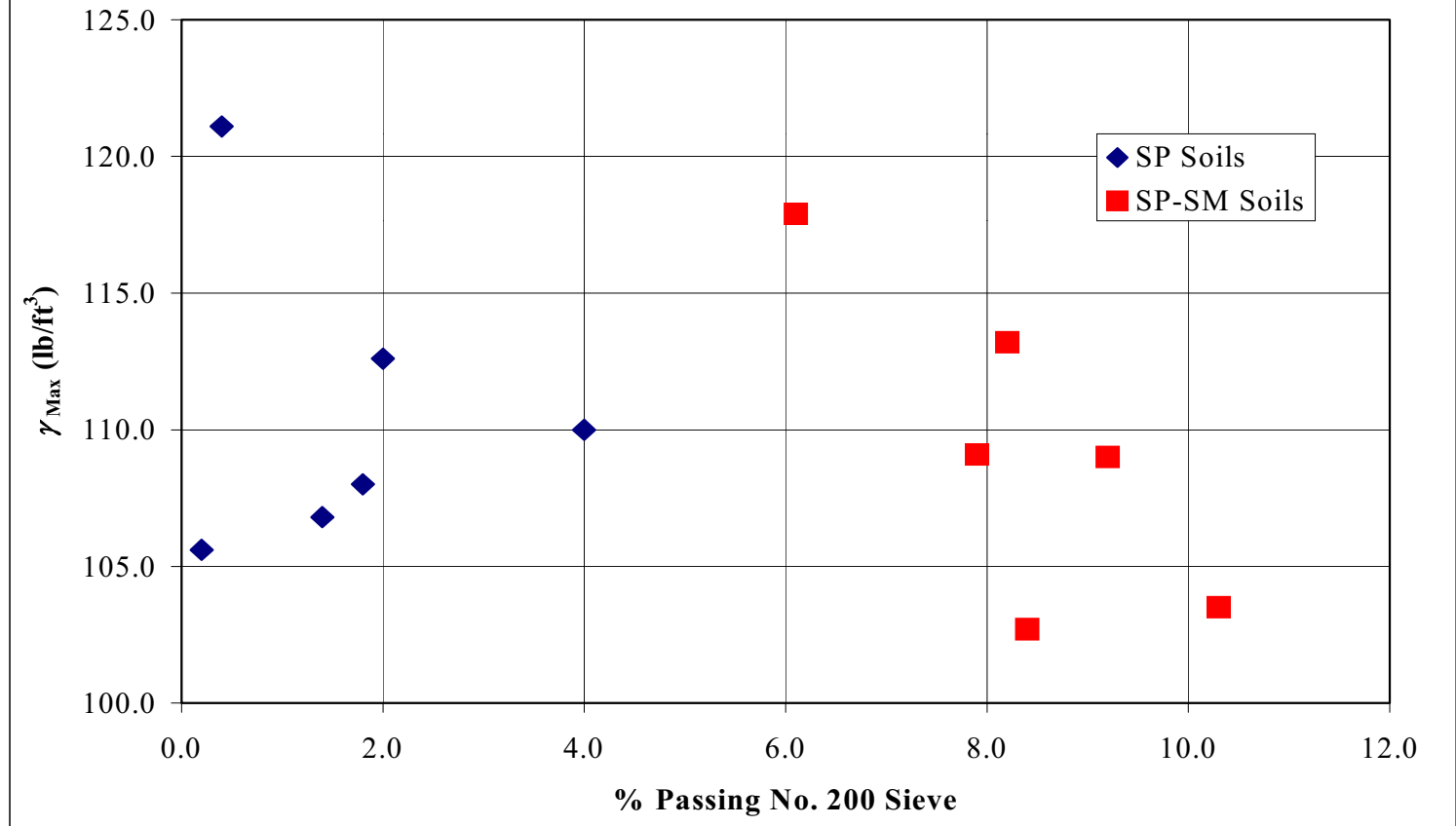

Figure 8.20: Relationship between Maximum Dry Density determined by ASTM D-1557 Modified Proctor Test Procedure and the Percent Passing the No. 200 Sieve

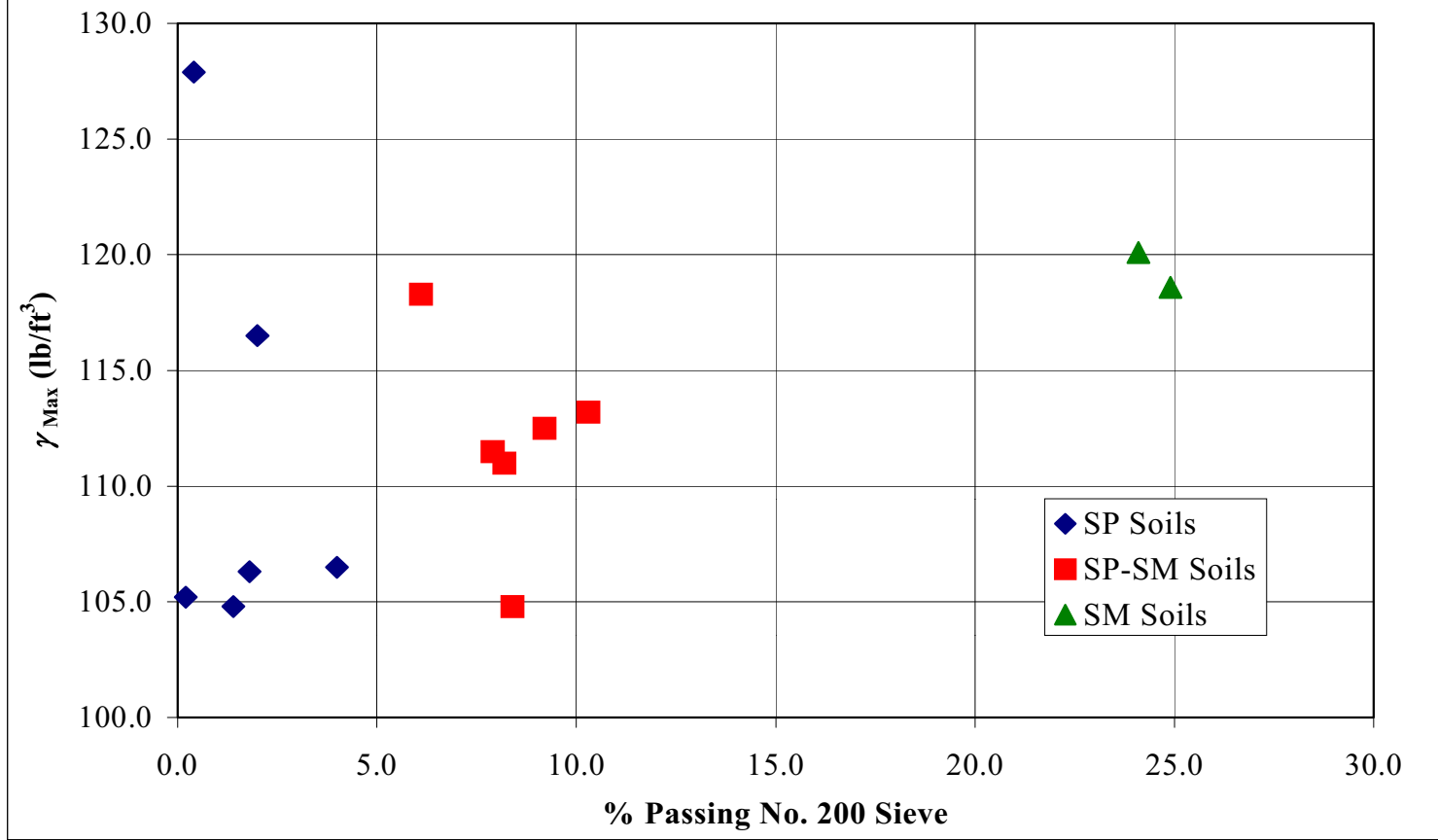

Figure 8.21: Relationship between Maximum Dry Density determined by TxDOT Tx-113E Test Procedure and the Percent Passing the No. 200 Sieve

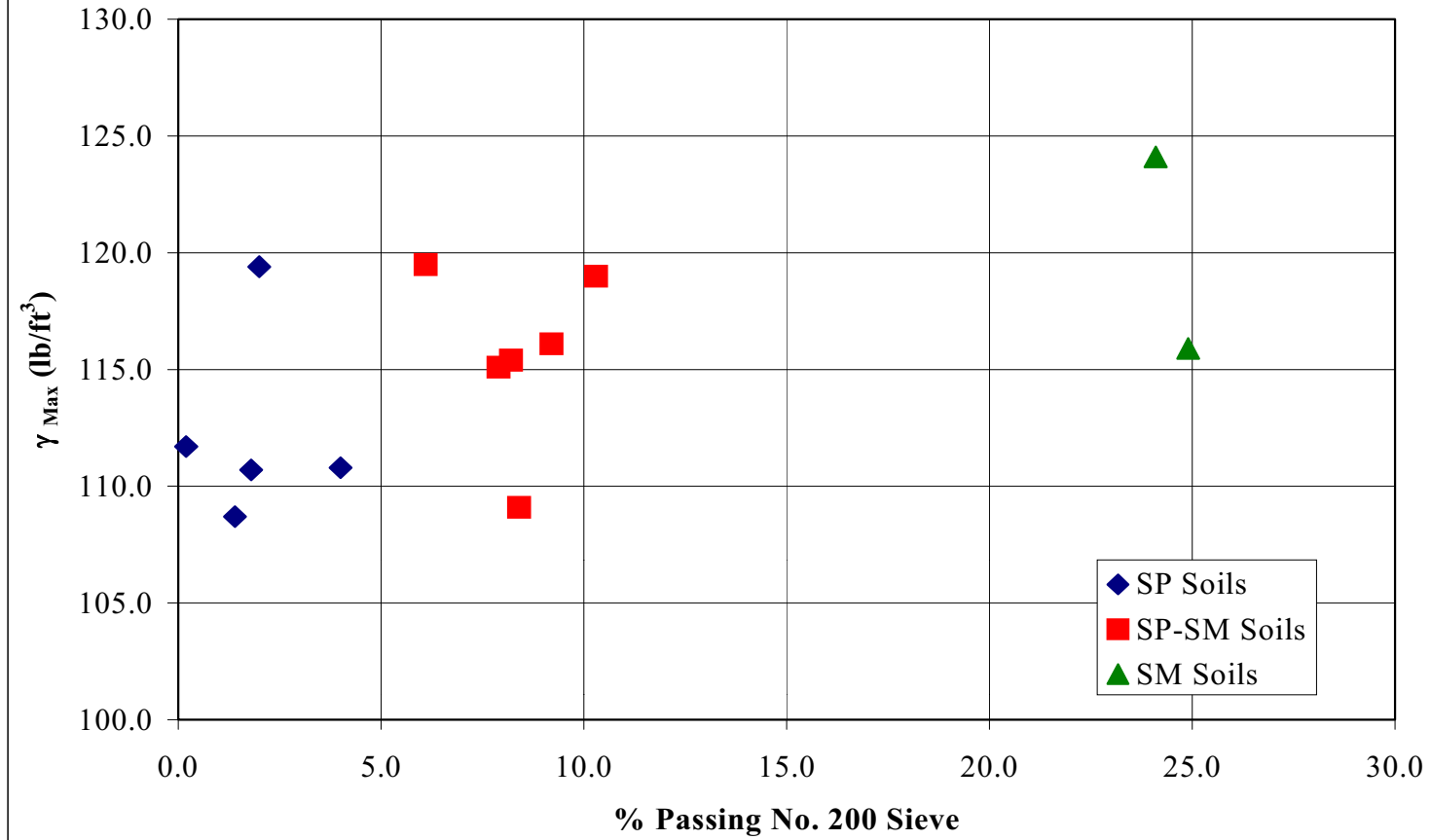

Figure 8.22: Relationship between Maximum Dry Density determined by BS-1377 British Vibratory Hammer Test Procedure and the Percent Passing the No. 200 Sieve

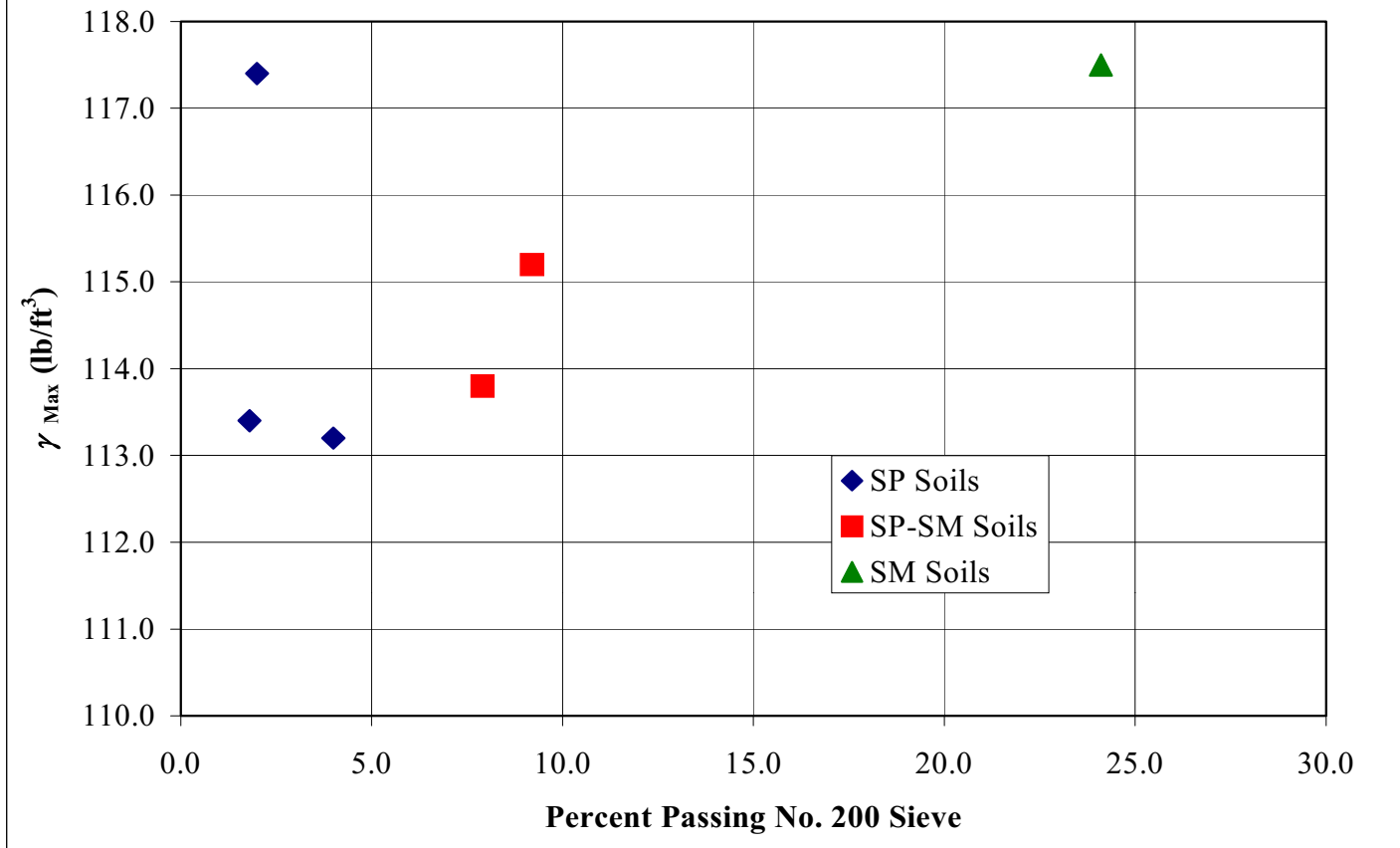

Figure 8.23: Percent Fine Sand (No. 40 Sieve to No. 200 Sieve)

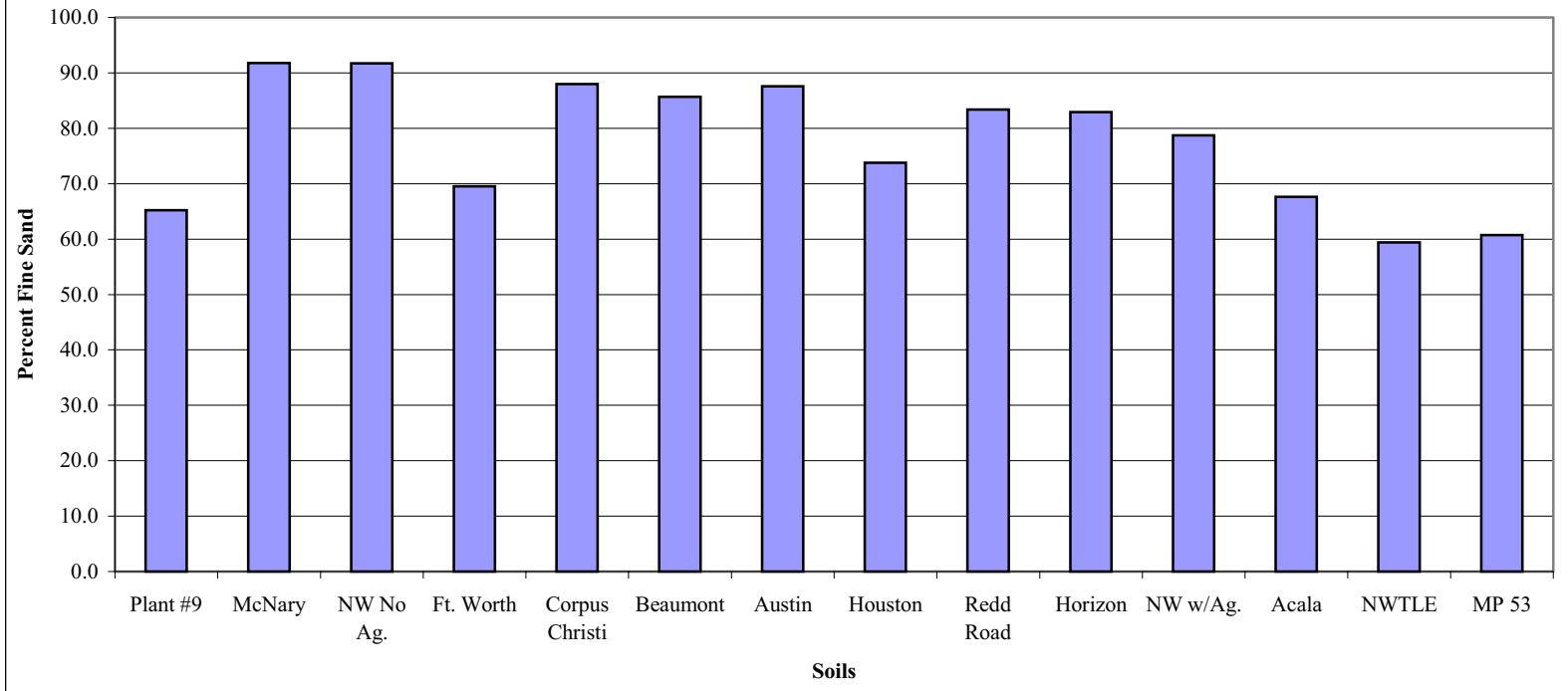

Figure 8.24: Relationship between Maximum Dry Density determined by ASTM D-4253 Maximum Index Density Procedure and the Percent Fine Sand (No. 40 - No. 200 Sieve Sizes)

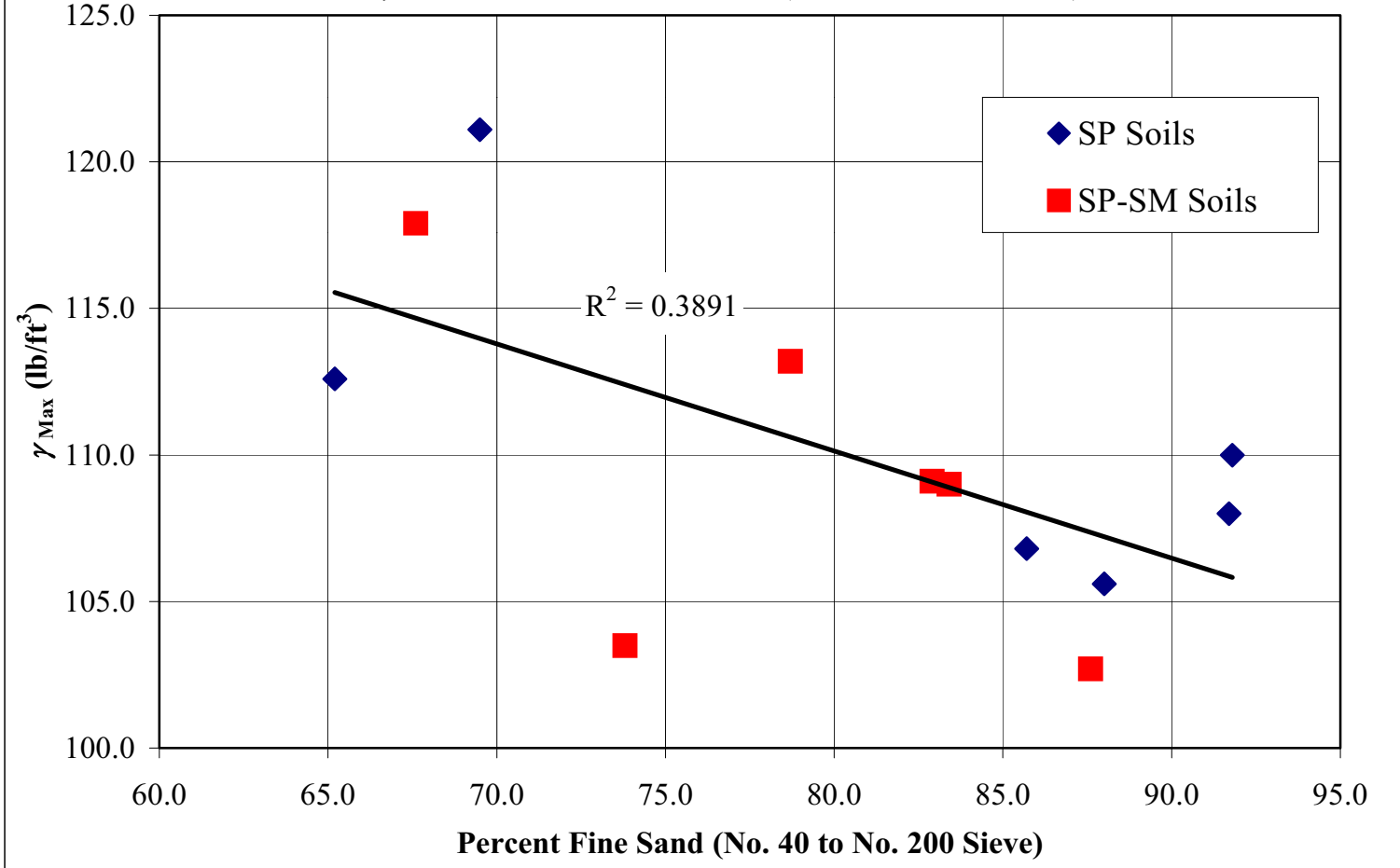

Figure 8.25: Relationship between Maximum Dry Density determined by ASTM D-1557 Modified Proctor Test Procedure and the Percent Fine Sand (No. 40 - No. 200 Sieve Sizes)

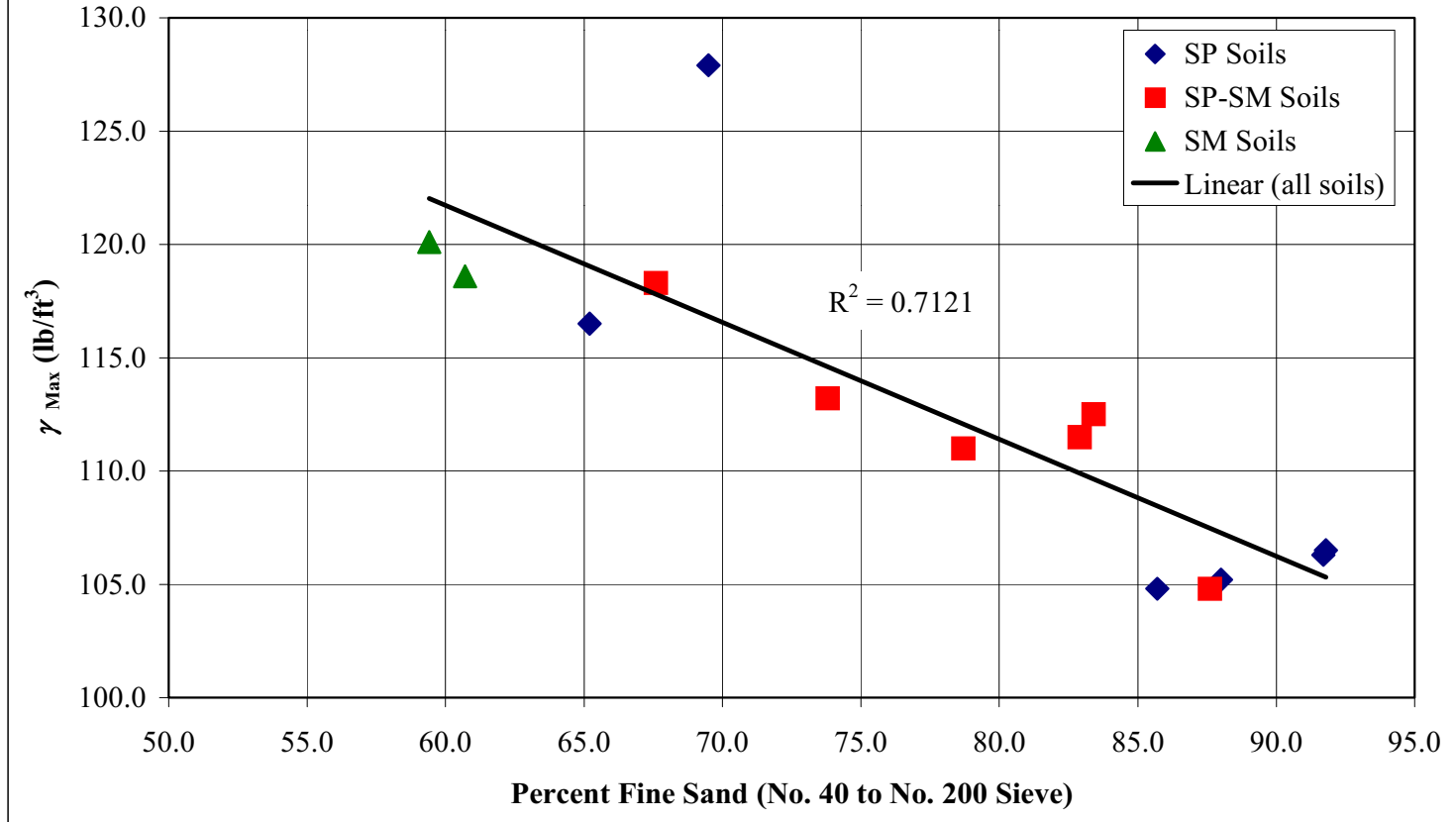

Figure 8.26: Relationship between Maximum Dry Density determined by TxDOT Tx-113E Test Procedure and the Percent Fine Sand (No. 40 - No. 200 Sieve Sizes)

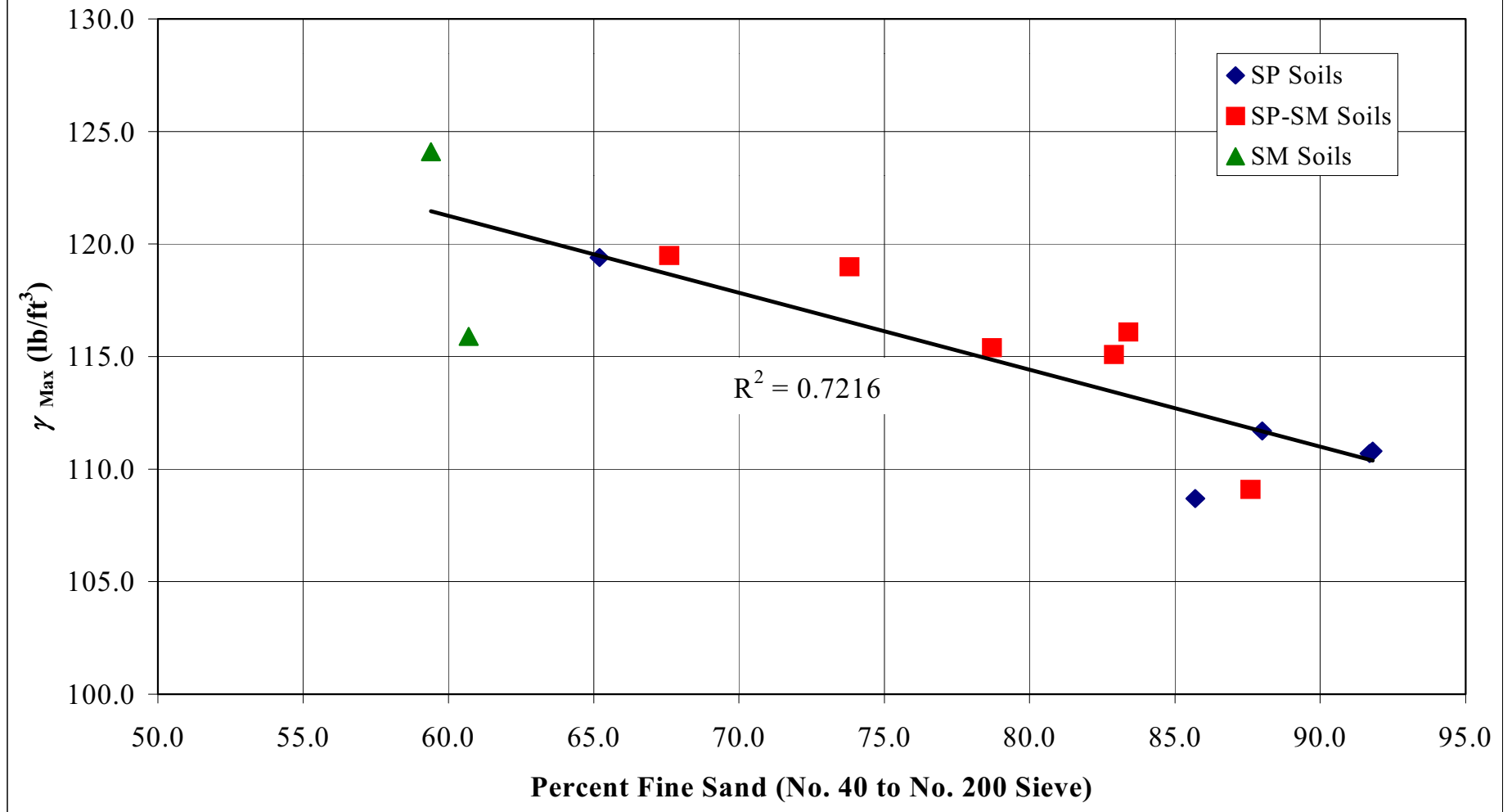
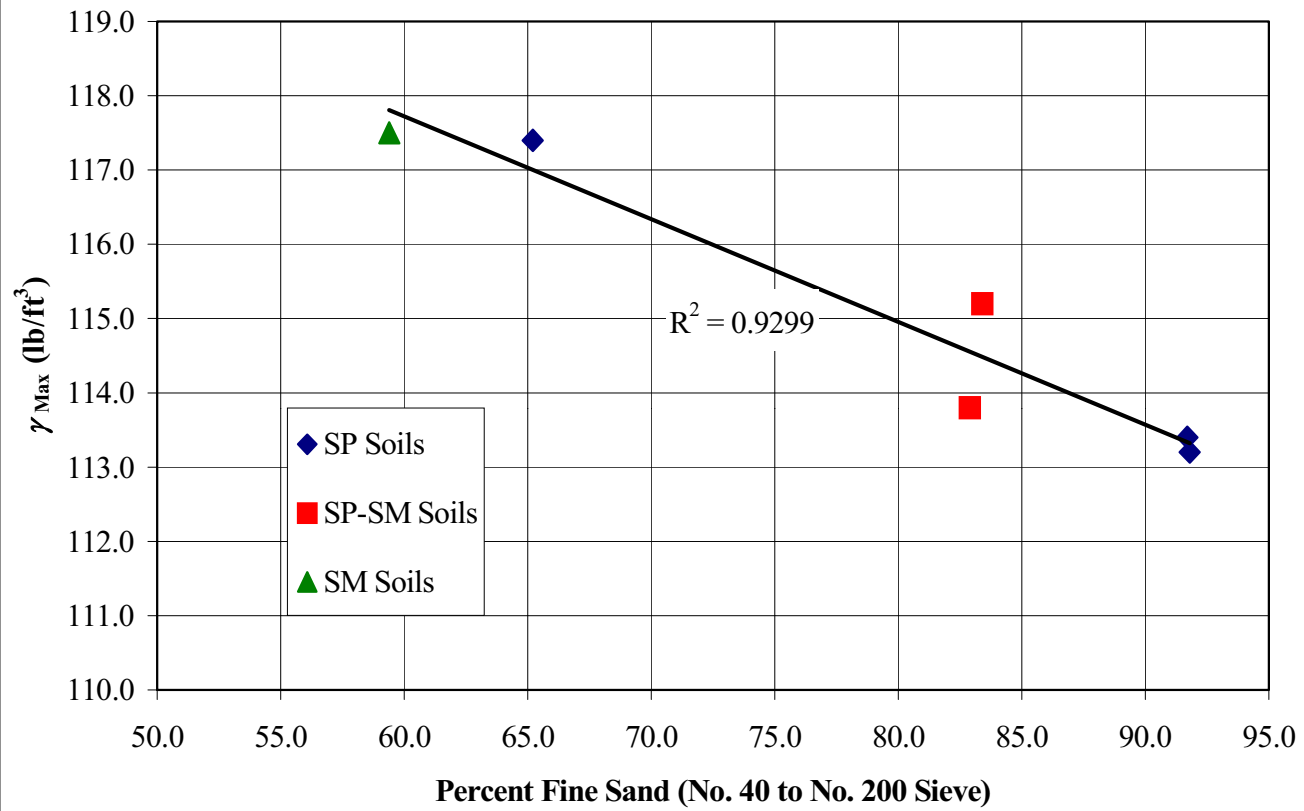

Figure 8.27: Relationship between Maximum Dry Density determined by BS-1377 British Vibratory Hammer Test Procedure and the Percent Fine Sand (No. 40 - No. 200 Sieve Sizes)



maximum dry densities obtained by the Modified Proctor, TxDOT, and British Vibratory Hammer compaction procedures were 0.71, 0.72, and 0.93, respectively. These correlation coefficients indicate potential relationships between the percent fine sand and the maximum dry densities obtained by the Modified Proctor, TxDOT, and British Vibratory Hammer compaction procedures. The relationships indicate that the maximum dry densities generally decrease as the percentage of fine sand increases. The correlation coefficient between the percent fine sand and the maximum dry densities obtained by the Maximum Index Density was 0.39. This correlation coefficient indicates that there is no direct relationship observed for the densities obtained by the Maximum Index Density procedure.

8.7.4 Summary of Correlation between Soil Gradation and Moisture-Density Relationships from Various Compaction Tests

For the most part maximum dry density could not be correlated with particle size distribution for any of the compaction procedures. There appeared to be an approximate linear relationship between the percentage of fine sand and the maximum dry densities, especially for Modified Proctor, TxDOT, and British Vibratory Hammer compaction procedures and, to a much lesser degree, with the Maximum Index Density procedure. The coefficients of uniformity (C_u) and curvature (C_c) for the majority of the soils tested were within a narrow range. Values of C_u ranged from 1.5 to 18.0; values of C_c ranged from 0.4 to 6.7. Test data for a larger variety of soils with a wider range of C_u and C_c might reveal a relationship between these coefficients and the maximum dry density not observed during this research. In fact, relationships between C_u and maximum dry density have been observed for larger ranges of coefficients of uniformity by other researchers (Lacroix and Horn 1973; Leary and Woodward 1973; Poulus and Head 1973) and by Delphia (1998) as described in the next section.

8.8 COMPARISON WITH FINDINGS OF TTI STUDY

Delphia (1998) performed compaction tests using the Standard Proctor (ASTM D-698), Modified Proctor (ASTM D-1557), and British Vibratory Hammer (BS-1377) procedures on sixty-two soils classified as SP and SW soils. Delphia found that the grain size distribution, shape of particles, and different laboratory compaction methods all affected

the maximum dry density of the soils tested. The Modified Proctor and British Vibratory Hammer procedures produced higher maximum dry densities than the Standard Proctor procedure for all soils tested by Delphia. For soils with C_u less than 3.5, the British Vibratory Hammer procedure produced the highest maximum dry densities. The maximum dry densities obtained using the Modified Proctor and British Vibratory Hammer procedures produced nearly identical maximum dry densities for soils with C_u greater than 3.5. Delphia developed a generalized relationship between C_u and maximum dry density for the Modified Proctor and British Vibratory Hammer procedures.

The results of this research are in general agreement with Delphia's study. The relationships established by Delphia between the uniformity coefficient, C_u , and the maximum dry densities from the Modified Proctor and British Vibratory Hammer tests are illustrated in Figures 8.28 and 8.29, respectively. Data from Delphia's study, as well as the current study, are both plotted on these figures. Both figures indicate that the maximum dry densities obtained for the soils in this study are within the range of values reported by Delphia. However, the soils tested for the present study had a narrow range of C_u . The maximum dry densities obtained with the British Vibratory Hammer procedure in both the Delphia and the present study were larger than the densities obtained by the Modified Proctor procedure. Thus, all data from the two studies appear to be consistent.

Figure 8.28: Relationship between Maximum Dry Density (lb/ft^3) from Modified Proctor Procedure and Coefficient of Uniformity (C_u) from Delphia (1998) Study and This Study

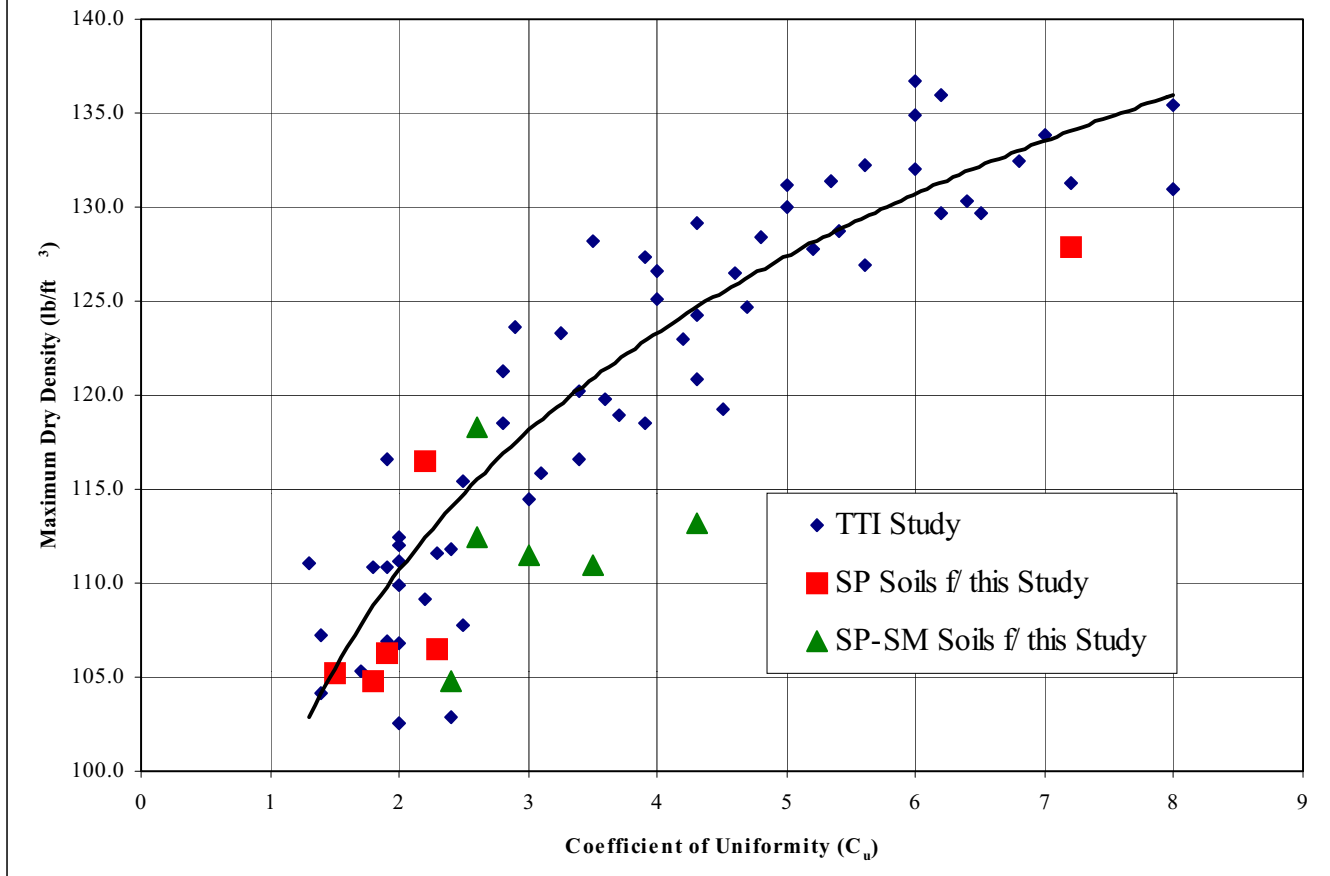
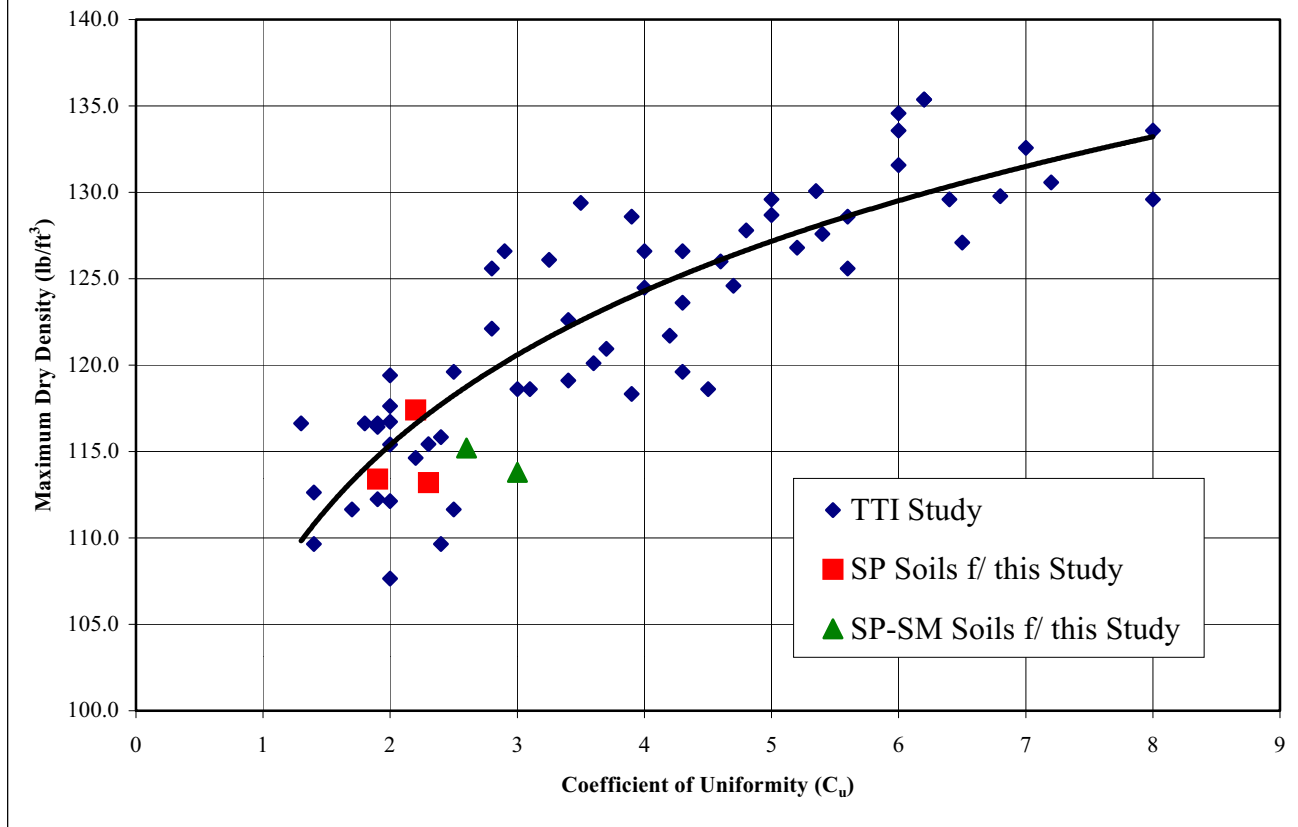

Figure 8.29: Relationship between Maximum Dry Density (lb/ft^3) from British Vibratory Hammer Procedure and Coefficient of Uniformity (C_u) from Delphia (1998) Study and This Study



8.9 SUMMARY OF ANALYSIS OF COMPACTION TEST RESULTS

Based on an examination of the results from the various compaction tests the following has been found:

- 1) Maximum dry densities determined from the TxDOT and British Vibratory Hammer tests were similar. The maximum densities from both procedures were greater than the maximum densities from the Modified Proctor and Maximum Index Density procedures.
- 2) The maximum densities determined by the Modified Proctor procedure were generally at least as large as the maximum densities from the Maximum Index Density procedure for the SP-SM and SM soils tested.
- 3) The maximum densities from the Modified Proctor procedure varied from greater to less than the maximum densities from the Maximum Index Density procedure for the SP soils tested.
- 4) The lack of confinement of the surficial soils during the Modified Proctor procedure may result in cases where the Modified Proctor procedure produces lower densities than the Maximum Index Density procedure.
- 5) Increasing the compactive energy imparted for either vibratory or impact compaction causes an increase in the maximum dry density.
- 6) The soils classified as SP soils generally do not have compaction moisture-density curves with a single, well-defined peak.
- 7) Maximum dry densities and optimum moisture contents for the SP soils generally occur at optimum moisture contents around zero.
- 8) Particle breakage is generally not significant for weathered quartz sands. Softer sands or weakly cemented particles may experience significant particle breakage during impact compaction tests.
- 9) Maximum dry densities were not readily correlated with particle size or particle size distribution. This finding may be due partly to the narrow range in particle size tested. However, it was found that as the percentage of fine sand (No. 40 to No. 200 Sieve) increased, the maximum dry densities generally decreased.

10) The maximum dry densities obtained in the study by Delphia (1998) and the present study were consistent. In both studies, the British Vibratory Hammer produced higher maximum dry densities than the Modified Proctor procedure.

CHAPTER NINE

EVALUATION OF COMPACTION TEST PROCEDURES AND RECOMMENDATIONS FOR COMPACTION SPECIFICATIONS

9.1 INTRODUCTION

The goal of this research is to determine appropriate compaction procedures and specifications for controlling the placement of cohesionless backfill. Particular emphasis has been placed on uniform (poorly graded) fine sands and silty sands. In this chapter, the current Texas Department of Transportation (TxDOT) compaction specifications are evaluated and recommendations are provided for improving the compaction of cohesionless soils. These recommendations are based on the results of the compaction tests presented in the preceding chapters.

During this project, difficulties were experienced with the compaction of cohesionless backfill behind a retaining wall for a TxDOT construction project in Austin, Texas. This provided an opportunity to observe a field project and identify some of the critical variables that control the placement of cohesionless backfill. Several of these variables are discussed in this chapter as topics for future study to mitigate the observed problems with compaction of cohesionless backfill.

9.2 CURRENT TXDOT COMPACTION SPECIFICATIONS FOR COHESIONLESS SANDS

From its inception, this project was focused on evaluating specifications for embankment construction using cohesionless backfill. As the project evolved, it became more narrowly focused on evaluation of compaction specifications for cohesionless soils. TxDOT's standard specifications (*Standard Specifications for Construction of Highways, Streets and Bridges* 1993) contain requirements for compaction of embankment and backfill materials behind mechanically stabilized earth (MSE) retaining structures (Items 132 and 423 and of TxDOT's standard specifications, respectively).

9.2.1 Material Specifications for Embankments

TxDOT allows for a wide range of soils to be specified for the construction of embankments. The most common materials specified for embankments are referred to as Type A. When Type A materials are not required, acceptable embankment materials are specified as any material approved by the project engineer of record. Type A material must have a liquid limit and plasticity index less than or equal to 45 and 15, respectively. All of the soils tested for this project meet this requirement. Type A embankment materials are also required to have a linear bar shrinkage greater than or equal to two. None of the poorly graded sand (SP) soils tested for this project meet the linear bar shrinkage requirement.

9.2.2 Material Specifications for MSE Backfill

TxDOT specifications require that MSE backfill conforms to the gradation limitations shown in Table 9.1. The gradation requirements shown in Table 9.1 indicate that a wide range of sand and gravel soils is permissible as backfill as Type A and Type B materials.

Table 9.1: Gradation limitations specified by TxDOT for Type A and Type B backfill behind mechanically stabilized earth (MSE) retaining structures

	Sieve Size	Percent Passing
Type A	3 inches	100
	# 40	0 - 60
	# 200	0 - 15
Type B	6 inches	100
	3 inches	75 - 100
	# 200	0 - 15

The specifications also allow materials with up to 25 percent by weight passing the No. 200 sieve to be used as backfill if the plasticity index of the soil does not exceed six and the angle of internal friction is greater than 34 degrees. This study focused mostly on the more marginal materials in the acceptable range, rather than the full range of acceptable materials. Two of the SP soils tested for this project meet the requirements of a Type A backfill material. The four other SP soils and six SP-SM soils are classified as Type B material. The two SM soils tested do not meet the gradation requirements for either Type A or Type B material.

9.2.3 Specified Laboratory Compaction Test for Cohesionless Soils

The primary laboratory procedure specified for determining the maximum dry density of materials for embankments and MSE backfill is the Tx-114-E procedure. The Tx-114-E laboratory procedure is described in the *TxDOT Manual of Testing Procedures* (1993), a separate manual from the standard specifications. The Tx-114-E procedure is patterned after the Standard Proctor test (ASTM D-698) and applies a compactive energy of 12,375 ft-lb/ft³. As part of the Tx-114-E procedure, special provisions are made for cohesionless soils. The Tx-114-E procedure stipulates that another test procedure, Tx-113-E, should be used for determination of moisture-density curves for cohesionless sands. The TxDOT laboratory manual defines cohesionless sand as:

“Cohesionless sand is defined as a sandy soil that, when wetted to slightly below optimum water content, mixed thoroughly and molded in four 2-inch lifts, the layer is sheared or teared by the ram in excess of 1-inch on the 50th blow.”

The definition implies that a complete moisture-density curve should be developed for potential cohesionless sand i.e., that optimum moisture content is defined using the Tx-114-E procedure first. The definition also implies that the Tx-113-E procedure for “cohesionless sand” should only be used if the soil is sheared more than 1 inch on the last blow using the Tx-114-E procedure.

Although the Tx-113-E test procedure in the manual is titled “Laboratory Compaction Characteristics and Moisture-Density Relationships of Base Materials and Cohesionless Sands,” the procedure really involves two distinctly different procedures. One test procedure

is used for determining the moisture-density relationships of base materials. This procedure is similar to the Tx-114-E procedure, except a compactive effort of 22,918 ft-lb/ft³ is applied, while the Tx-114-E procedure requires a compactive effort of 12,375 ft-lb/ft³. The second procedure described for Tx-113-E is the test procedure actually described in Chapter 3 of this report for compaction of cohesionless sands.

9.2.4 Current TxDOT Compaction Control Standards for Cohesionless Soils

The moisture and density requirements specified by TxDOT for embankment soils are based upon the plasticity index of the material. The current TxDOT compaction specifications for embankments require that cohesionless materials be compacted to 98 percent of the maximum dry density obtained by the TxDOT laboratory procedure, Tx-113-E. The moisture content of each layer must be brought to and maintained at a level necessary to achieve the specified density. No other specific requirements are delineated by the current TxDOT specifications for the compaction of cohesionless soil for embankments.

The TxDOT compaction specifications for MSE backfill require the top 3 feet of backfill under travel ways to be compacted to 95 percent of the maximum dry density obtained by the TxDOT laboratory procedure, Tx-113-E. All other areas must be compacted to at least 90 percent of the maximum dry density obtained by the Tx-113-E test procedure. TxDOT specifications also require contractors to compact the backfill in such a way that distortion or damage of the retaining wall and reinforcing system of the wall does not occur. The contractor is required to remove and replace any section of the retaining wall that becomes distorted. A 3 ft wide strip immediately behind the retaining wall must be compacted with either hand-operated or walk-behind compaction equipment. Larger static or vibratory rollers are not permitted in this 3 ft zone.

9.3 ALTERNATIVE COMPACTION CONTROL STANDARDS

Relative density, using the Maximum and Minimum Index Density procedures, is probably the best measure of degree of compaction for cohesionless soils (Burmister 1948; Das 1994). However, Christensen (1999) and Farrar (1999) indicated that relative density is not used to measure and control the densities of cohesionless soils by state transportation

departments. Tavenas (1973) stated that one of the primary reasons for not using relative density to control compaction is the poor reproducibility of tests for Maximum and Minimum Index Density among laboratories. The Maximum Index Density procedure is especially likely to yield differences among laboratories because the same vibratory tables are not always used and the vibratory tables are difficult to calibrate (Tavenas 1973; Farrar 1999). Another reason for relative density not being used as a measure of compaction is that it requires three measurements of density for compaction control: maximum dry density, minimum dry density, and density in the field (Tavenas 1973; Tiedman 1973; Selig and Ladd 1973). Using three separate measurements to control compaction causes the errors associated with each of the measurements to be combined and create unacceptably large standard deviations for compaction control (Farrar, 1999).

Christensen (1999) performed a review of compaction specifications for forty-four state transportation departments. He discovered significant differences between the compaction requirements for coarse-grained (cohesionless sands) and fine-grained materials. Agencies that specified density based on material type required coarse-grained soils to have higher densities than fine-grained soils. These agencies also placed no moisture requirement on compaction of coarse-grained soils as long as field density was achieved. The Standard Proctor test is the most widely used test for determining the maximum dry density and optimum moisture content. The Standard Proctor test is used exclusively by twenty-six agencies and only three agencies specify only the Modified Proctor test. Either Standard or Modified Proctor is specified by six states. Ten states (including Texas) specify modifications of the Standard or Modified Proctor test. Agencies that used both Standard and Modified Proctor tests specified the use of the Modified Proctor test for coarse-grained soils.

Although Christensen found the Standard Proctor test to be the most widely specified test by state and federal agencies, other researchers have found that the Standard Proctor (ASTM D-698 or Tx-114-E) test is inappropriate for compaction control of clean sands (SP, SW) and sands with less than 12 percent passing the No. 200 sieve (Holtz 1973; Townsend 1973; Poulos and Head 1988; National Research Council 1965). For these soils, the Maximum Index Density (Holtz 1973; Townsend 1973) or Modified Proctor (Poulos and

Head 1988; National Research Council 1965; Farrar 1999) is considered to be the best test method for determining the maximum dry density of cohesionless soils. The Modified Proctor is preferred for compaction control over the Maximum Index Density procedure because the testing equipment and procedures for the Modified Proctor procedure are more widely available and understood than the Maximum Index Density test.

9.4 RECOMMENDATIONS FOR COMPACTION SPECIFICATIONS

Based on the compaction tests performed for this research, recommendations for compaction requirements for cohesionless soils like the ones tested have been formulated. Two different approaches and test procedures are recommended. One of the recommended approaches is the use of the TxDOT Tx-113-E procedure; the other is the Modified Proctor test procedure. The following paragraphs present these two approaches.

9.4.1 Recommendations for Modified Proctor Test

The Modified Proctor (ASTM D-1557) compaction procedure is the favored approach for determining reference densities for cohesionless sands. The test method is more widely used for determining maximum index density than other procedures. Most soil laboratories perform the Modified Proctor test on a routine basis and achieve consistent results. The Modified Proctor test is more reliable and requires less specialized equipment than the Maximum and Minimum Index Density tests, which are not used by any state transportation agencies. The maximum densities produced by the Modified Proctor are known to be attainable in the field. Based on these arguments, the following recommendations are made:

- (1) These recommendations are applicable to “cohesionless soils,” defined as all soils that classify as SW, SP, SW-SM, SP-SM, or SP-SC by the Unified Soil Classification System (USCS) classification system (ASTM D-2487). Soils falling into one of these USCS classifications have less than 12 percent by weight passing the No. 200 sieve.
- (2) Modified Proctor (ASTM D-1557) compaction procedures are recommended for setting and specifying required minimum densities for soils that meet this definition of “cohesionless soil.”

- (3) Soils should be compacted to at least 95 percent of the maximum dry density determined by the Modified Proctor (ASTM D-1557) test.

9.4.2 Recommendations for TxDOT Test

If Modified Proctor is not a feasible or practical procedure for setting and specifying required minimum densities, then the Tx-113-E procedure described in Chapter 3 is recommended as a less desirable alternative. The primary advantage of the TxDOT Tx-113-E test is that it currently exists in TxDOT specifications and laboratory manuals. The disadvantages of the TxDOT test are that the procedure is more complicated than the Modified Proctor test and at least some changes of the procedure are required. The following recommendations have been developed for use of the TxDOT test:

- (1) TxDOT's current definition of a "cohesionless soil" should be eliminated.
- (2) The definition of "cohesionless soil" defined in the Modified Proctor recommendations is applicable for the TxDOT test.
- (3) Embankment or MSE backfill soils that meet this definition of "cohesionless soil" should use the Tx-113-E test for setting and specifying required minimum densities.
- (4) If the Tx-113-E procedure is specified, then "cohesionless soils" should be compacted to at least 92 percent of the maximum dry density determined by the TxDOT Tx-113-E test. This percentage was determined by computing the average percent compaction necessary for the TxDOT procedure to achieve 95 percent of the maximum dry density from the Modified Proctor procedure. A table showing this information for the "cohesionless soils" tested for this project is presented in Table 9.2. A plot of 92 percent of the maximum dry density from the TxDOT test versus 95 percent of the maximum dry density from the Modified Proctor test for the soils tested for this project is presented in Figure 9.1. From this figure, the average standard deviation of the data from a 45-degree line on this plot corresponds to a coefficient of determination (R^2) of 0.85. The computed standard deviation for this line is 1.1 lb/ft³.

Table 9.2: Average percent of maximum dry density from the TxDOT procedure that is equivalent to 95 percent of the maximum density from the Modified Proctor procedure

	γ_{\max} TxDOT	γ_{\max} Modified Proctor	95 Percent γ_{\max} Modified Proctor	Equivalent γ_{\max} TxDOT
Plant #9	119.4	116.5	110.7	92.7%
McNary	110.8	106.5	101.2	91.3%
NW No. Ag	110.7	106.3	101.0	91.2%
Corpus Christi	111.7	105.2	99.9	89.5%
Beaumont	108.7	104.8	99.6	91.6%
Austin	109.1	104.8	99.6	91.3%
Houston	119	113.2	107.5	90.4%
Redd Road	116.1	112.5	106.9	92.1%
Horizon	115.1	111.5	105.9	92.0%
MW w/Ag	115.4	111	105.5	91.4%
Acala	119.5	118.3	112.4	94.0%

Average =	91.6%
-----------	-------

Figure 9.1: Relationship between 92 Percent of TxDOT Tx-113E Maximum Dry Density and 95 Percent of Modified Proctor (ASTM D-1557) Maximum Dry Density

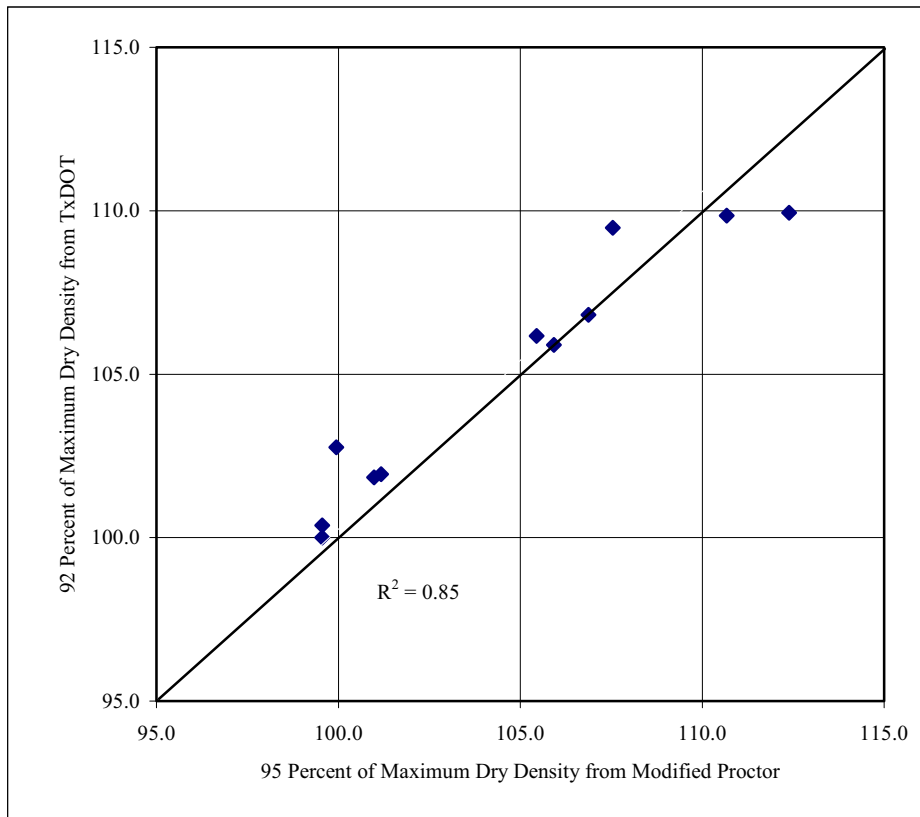

9.5 OBSERVATION OF FIELD PROBLEMS AND SUPPLEMENTAL RECOMMENDATIONS

This study was primarily a laboratory study; the work for this study did not include extensive field observations and monitoring. However, during the course of the study, one field construction site was visited where compaction difficulties were encountered. Problems were experienced with compaction of cohesionless backfill behind a MSE retaining wall near the US 290 and IH 35 interchange in Austin, Texas. A field and laboratory survey of the problems experienced during the construction of this retaining wall revealed some other important compaction issues that should be addressed when placing and compacting cohesionless fill materials.

9.5.1 Recommendations for Field Moisture-Density Measurements

In-situ moisture and density measurements were made for the Austin retaining wall backfill with a nuclear density gauge (ASTM D-3017, D-2922). The reported moisture and density measurements with the nuclear gauge were clearly incorrect on numerous occasions. The reported density measurements from the nuclear density were much lower than expected based upon visual observation of the compacted soil. In fact, one test measured a dry density less than the minimum density of the soil determined by the ASTM D-4254 procedure. Based upon these misleading density measurements, the contractor reportedly spent up to 3 hours compacting a single 8-inch lift of soil in order to achieve the necessary density. This included up to 70–80 passes with a 2-ton static roller. Several of the MSE wall panels experienced unacceptable lateral movements due to the overcompaction of the soil and had to be replaced by the contractor. Sand cone density tests (ASTM D-1556) were eventually performed and revealed dry densities about 10 lb/ft³ higher than those obtained by the nuclear gauge. The results of the sand cone tests indicated that the contractor was achieving the necessary density and that the additional compaction that caused distress of the retaining wall was not necessary. The inability of the nuclear density gauge to accurately measure the in-situ density of the sand backfill behind this retaining wall is of great concern. The calibration procedures for using the nuclear density gauge in the field for specific soils should be analyzed in order for these problems to be eliminated on future projects.

9.5.2 Recommendations for Moisture Control

During the construction of the Austin retaining wall, the densities of the sand backfill were thought to be too low and the backfill was flooded on several occasions in an effort to increase the density of the backfill. The result was that the soil was very wet of the optimum moisture content of the material. The moisture-density relationships for many of the soils tested for this study showed that the dry density decreased sharply when the compaction moisture content was increased wet of the optimum moisture content. Proper control of the moisture during construction in the materials that are moisture sensitive, especially the more silty sands, may be essential for achieving the necessary densities. The current TxDOT specifications do not provide any guidelines or recommendations for moisture control of cohesionless materials.

9.5.3 Recommendations for Compaction Equipment for MSE Backfill

The use of proper construction equipment for compaction of cohesionless backfill is another issue that must be addressed. This is especially true of backfill behind retaining structures, because overcompaction immediately behind the structure may lead to unacceptable lateral distortion of the wall. Scott (1980) indicated that for sand fills, vibratory rollers three or four times smaller than corresponding static rollers can achieve the same or even much higher densities than static rollers. During the compaction of the backfill at the retaining wall in Austin, two types of compaction devices were used. Small hand-operated vibratory plates were used to compact the soil within a 3-foot strip behind the retaining wall. A 2-ton static roller was used to compact the backfill behind this strip. Both compaction devices were found to achieve the necessary density for the backfill. These results indicated that the use of a small walk-behind vibratory roller probably would have produced at least the same density as the 2-ton roller at the Austin site. The use of smaller vibratory compaction devices for all backfill behind retaining structures should result in acceptable compaction of cohesionless backfill and minimize the potential for damage to retaining walls during construction.

CHAPTER TEN

SUMMARY

10.1 DESCRIPTION OF RESEARCH

The primary objective of this report was to determine and evaluate the maximum densities obtained by the following standardized compaction procedures: Modified Proctor (ASTM D 1557), Maximum and Minimum Index Density (ASTM D 4253 and ASTM D 4254, respectively), TxDOT (Tx-113-E), and British Vibratory Hammer (British Standard BS 1377). Ultimately the purpose of this effort was to develop a suitable specification for compaction of cohesionless fill materials.

Compaction tests were performed on fourteen soils from several regions of Texas. These soils represent cohesionless soils commonly used as fill materials by TxDOT. The soils consist of three different soil types based on the Unified Soil Classification System (USCS): poorly graded sand (SP), poorly graded sand with silt (SP-SM), and poorly graded silty sand (SM).

10.2 LABORATORY FINDINGS

The moisture-density relationships, maximum dry densities, and particle breakage during compaction were each examined and compared for the various compaction tests. The maximum densities from both the TxDOT and British Vibratory Hammer procedures were greater than the maximum densities from the Modified Proctor and ASTM Maximum Index Density procedures. The maximum densities determined by the Modified Proctor procedure were generally at least as large as the maximum densities from the Maximum Index Density procedure for the SP-SM and SM soils tested. The maximum densities from the Modified Proctor varied from greater to less than the maximum densities from the Maximum Index Density procedure for the SP soils tested. A special Modified Proctor compaction test indicated that the lack of confinement of the surficial soils during the Modified Proctor procedure is probably why the Modified Proctor (ASTM D 1557) procedure produced lower densities than the Maximum Index Density (ASTM D 4253) procedure.

The soils classified as SP soils generally do not have compaction moisture-density curves with a single, well-defined peak. Additionally, maximum dry densities and optimum moisture contents for the SP soils generally occurred at optimum moisture contents near zero. The SP-SM and SM soils tested generally had moisture-density curves with single, well-defined peaks.

Particle breakage was generally not significant for the weathered quartz sands tested for this project. Softer sands or weakly cemented particles may experience significant particle breakage during impact compaction tests. A significant amount of particle breakage did occur for one of the SM soils tested, which contained a significant amount of cemented caliche.

The maximum dry densities were not readily correlated with particle size or particle size distribution. This finding may be partly due to the narrow range in particle size tested. However, it was found that as the percentage of fine sand (No. 40 to No. 200 Sieve) increased, the maximum dry densities generally decreased. The maximum dry densities obtained in the study by Delphia (1998) and in the present study were consistent. In both studies, the British Vibratory Hammer produced higher maximum dry densities than the Modified Proctor procedure.

10.3 RECOMMENDATIONS

Based on the results of the tests performed in this study it is recommended that all soils classified as SW, SP, SW-SM, and SW-SP be compacted to 95 percent of the maximum dry density determined by the ASTM D 1557 (Modified Proctor) standard test method. However, the ASTM D 1557 test procedure is not currently a TxDOT standard test method. If use of the ASTM D 1557 procedure is considered not feasible or practical, compaction to 92 percent of the maximum dry density determined by the special TxDOT Tx-113E test procedure can be considered as an alternate. This special TxDOT procedure is the one utilizing the special “bow-tie” compaction hammer and neoprene pad and is noticeably more complex than the ASTM D 1557 test procedure.

Although this study was primarily a laboratory study, three supplemental recommendations for field control are offered based on the writer’s experience and

observations during the course of this study. First, calibration procedures for nuclear moisture-density gauges, including the implementation practices and checking of calibration, should be evaluated. Compaction moisture content should be controlled in the field for soils exhibiting a single, well-defined peak in the moisture-density curve. Compaction either too dry or too wet can lead to problems in any compacted cohesionless fill. Finally small vibratory rollers appear to be suitable for compacting cohesionless backfill behind MSE walls and minimize risk of damage. Use of rollers which are too large, operated too close to the wall or are only static (non-vibratory) may contribute to compaction problems.

APPENDIX A
GRAIN SIZE DISTRIBUTION CURVES

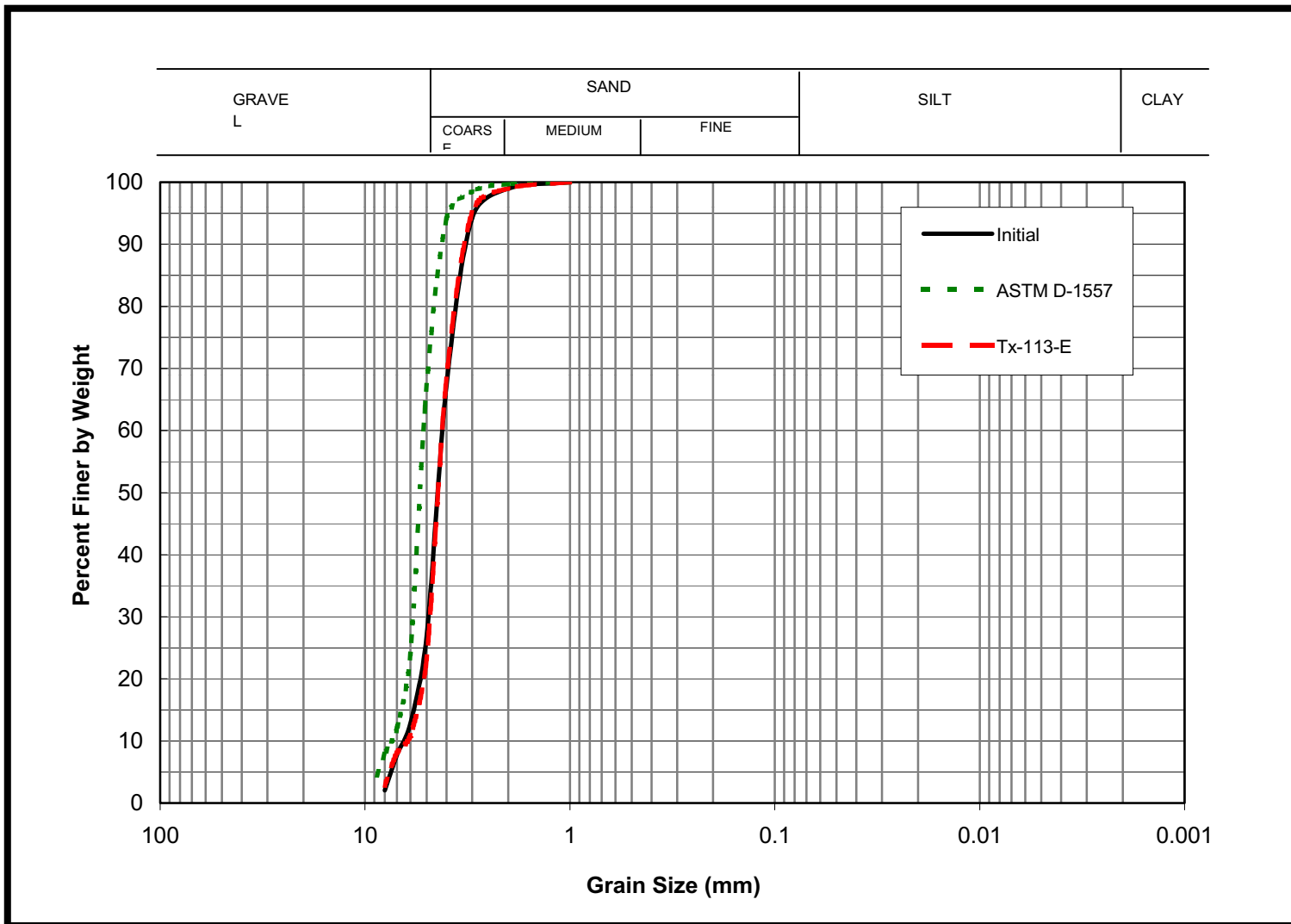

Figure A.1: Initial grain size curve of Plant # 9 soil (SP) and curves after impact compaction tests

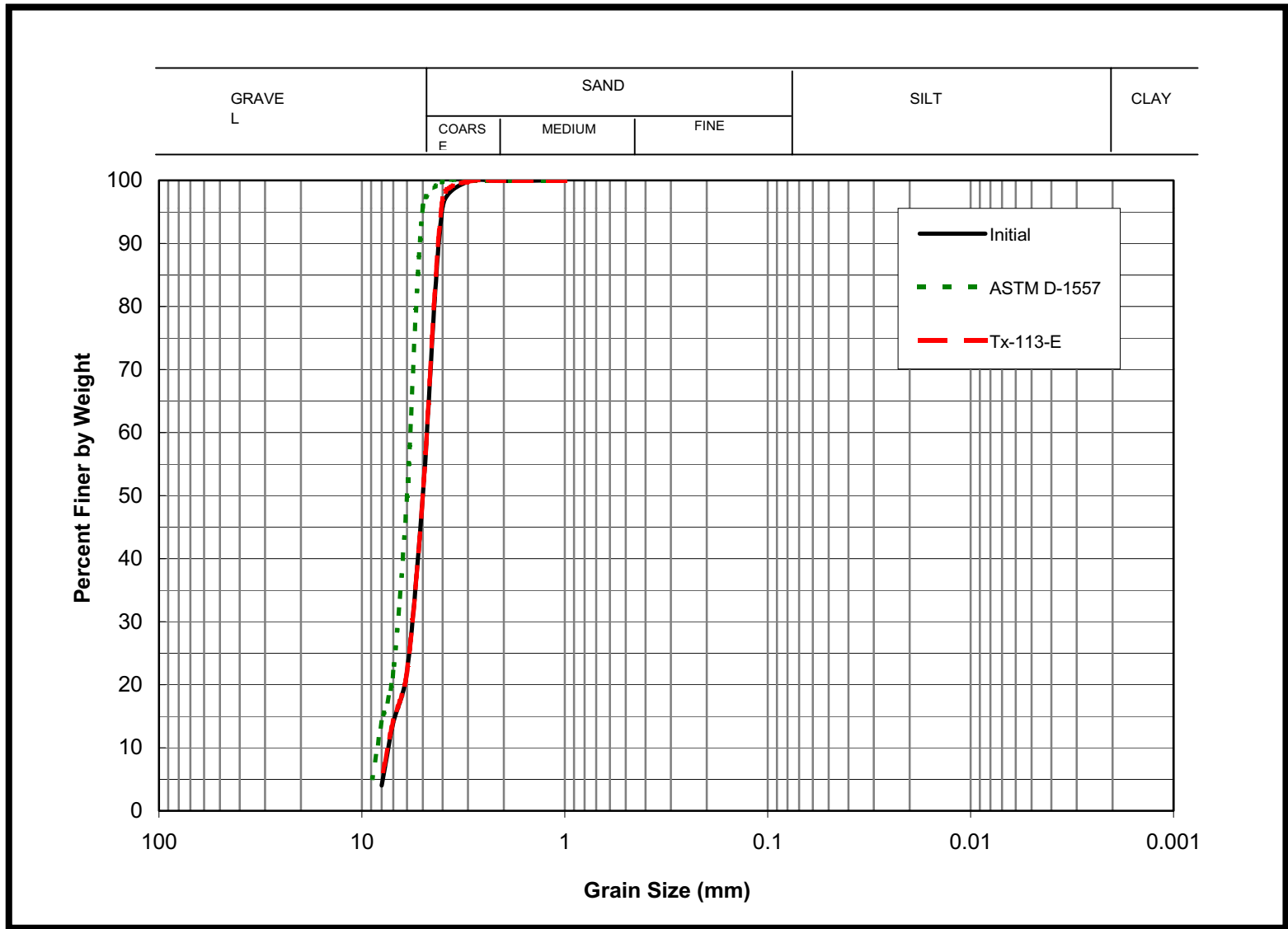

Figure A.2: Initial grain size curve of McNary soil (SP) and curves after impact compaction tests

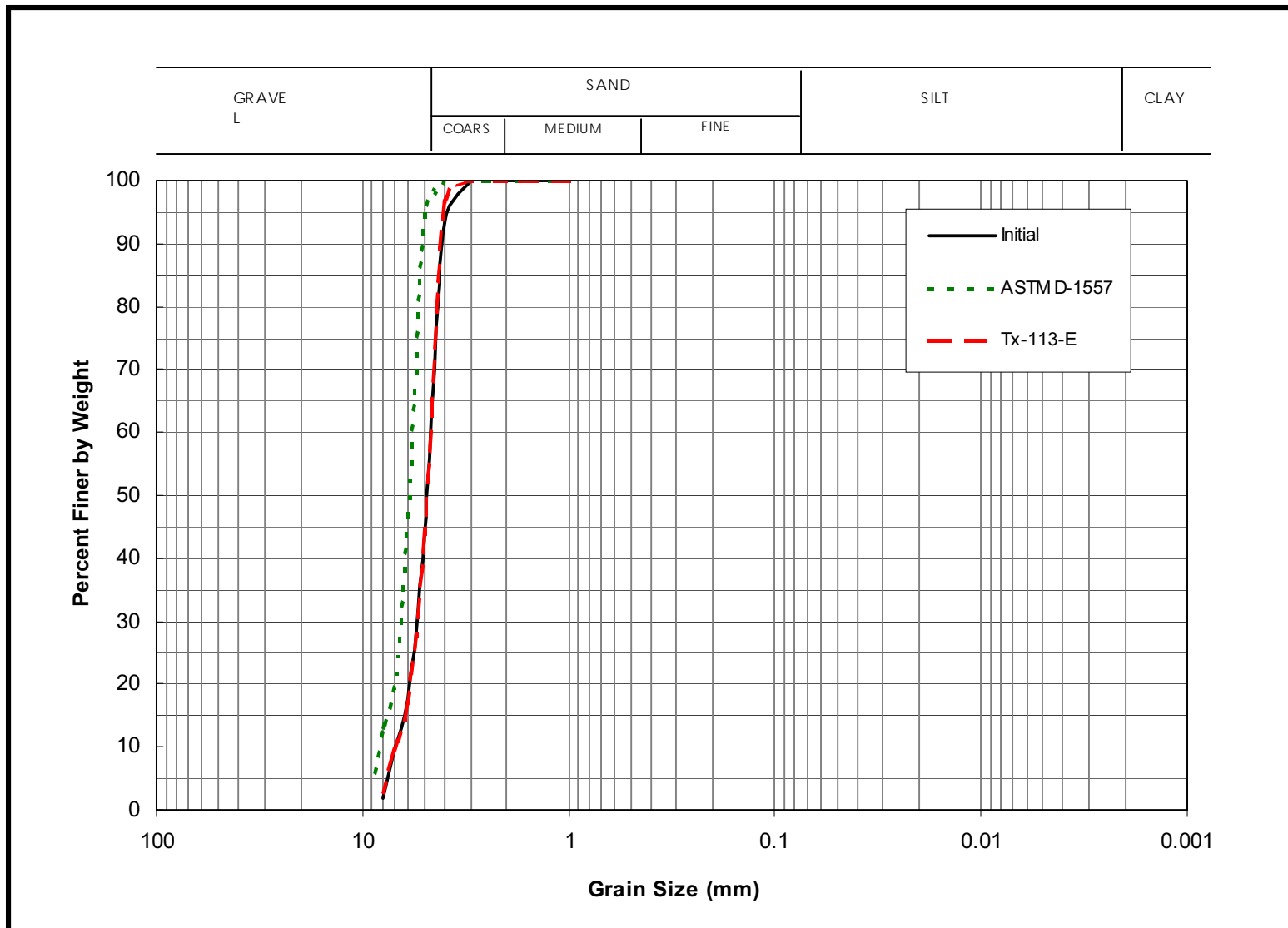

Figure A.3: Initial grain size curve of NW No Ag. soil (SP) and curves after impact compaction tests

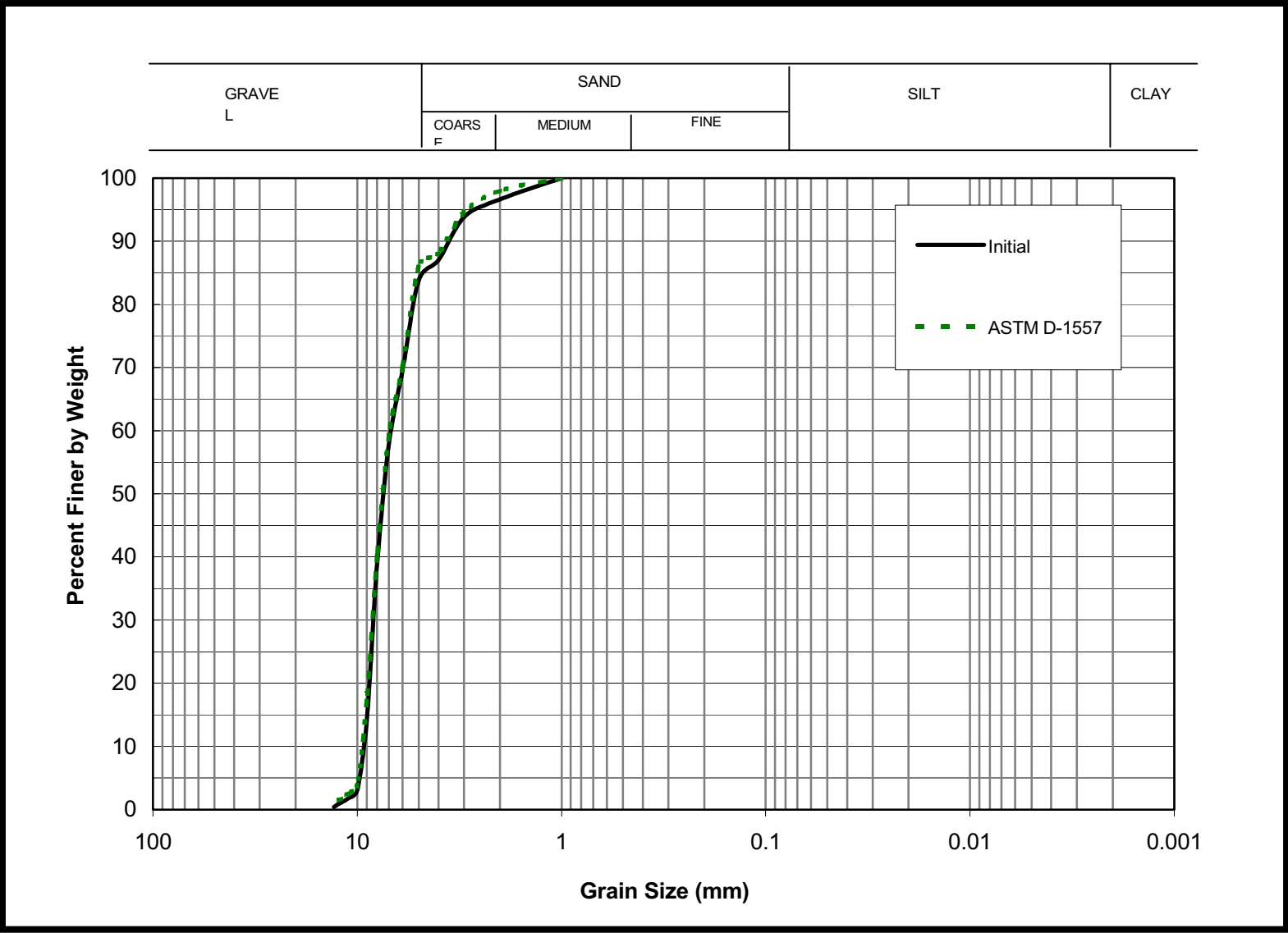

Figure A.4: Initial grain size curve of Ft. Worth soil (SP) and curves after impact compaction tests

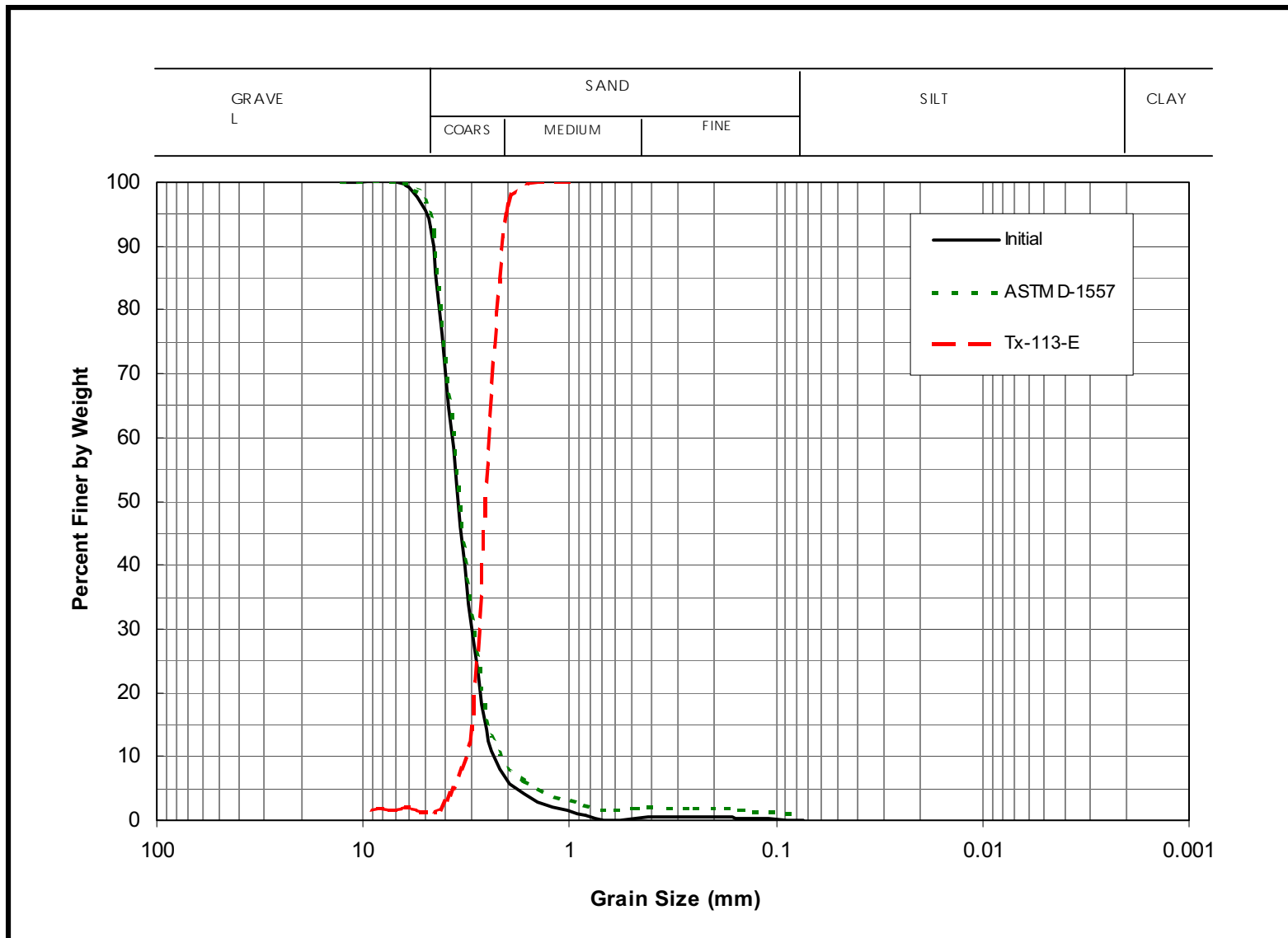

Figure A.5: Initial grain size curve of Corpus Christi soil (SP) and curves after impact compaction tests

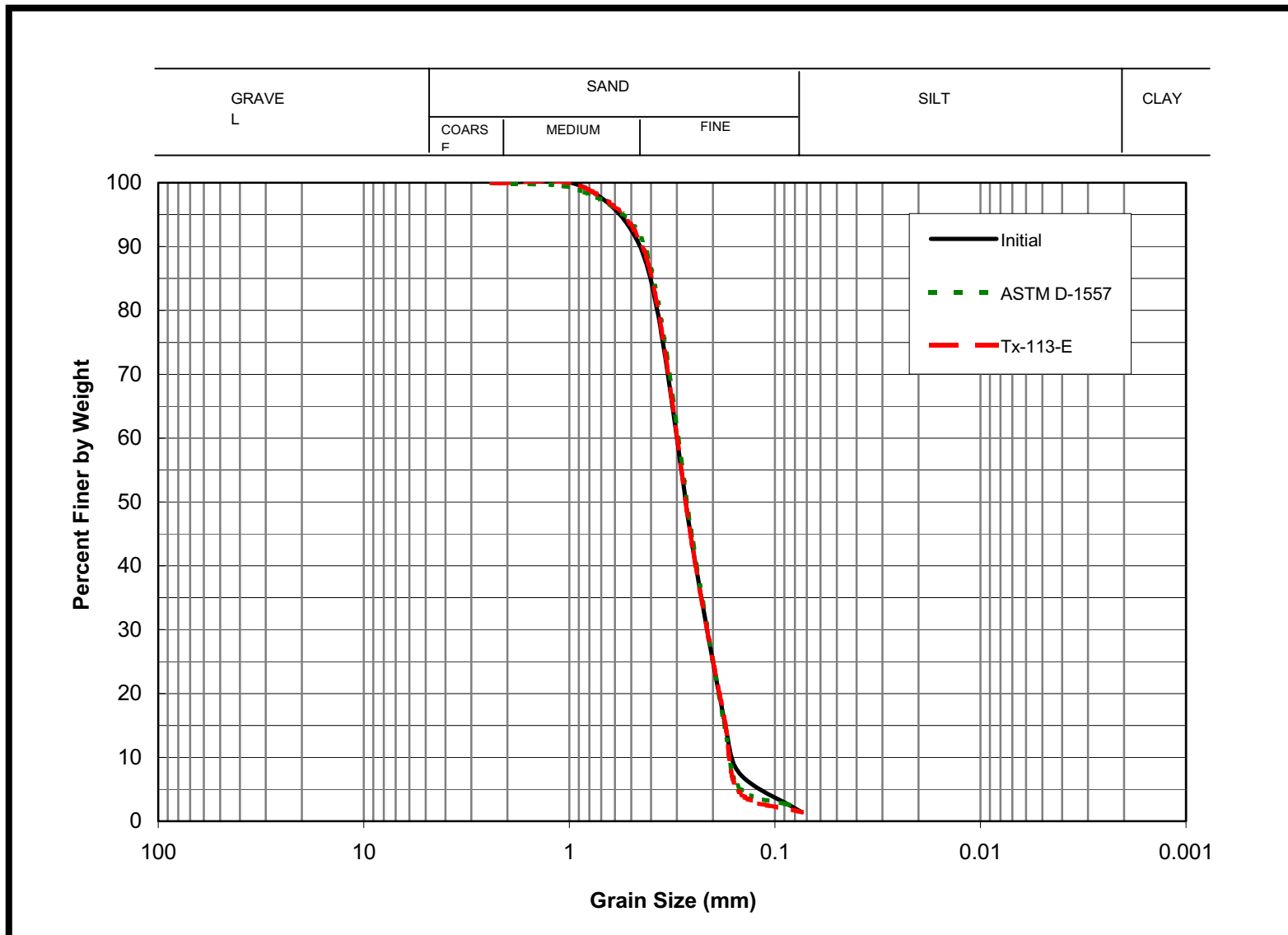

Figure A.6: Initial grain size curve of Beaumont soil (SP) and curves after impact compaction tests

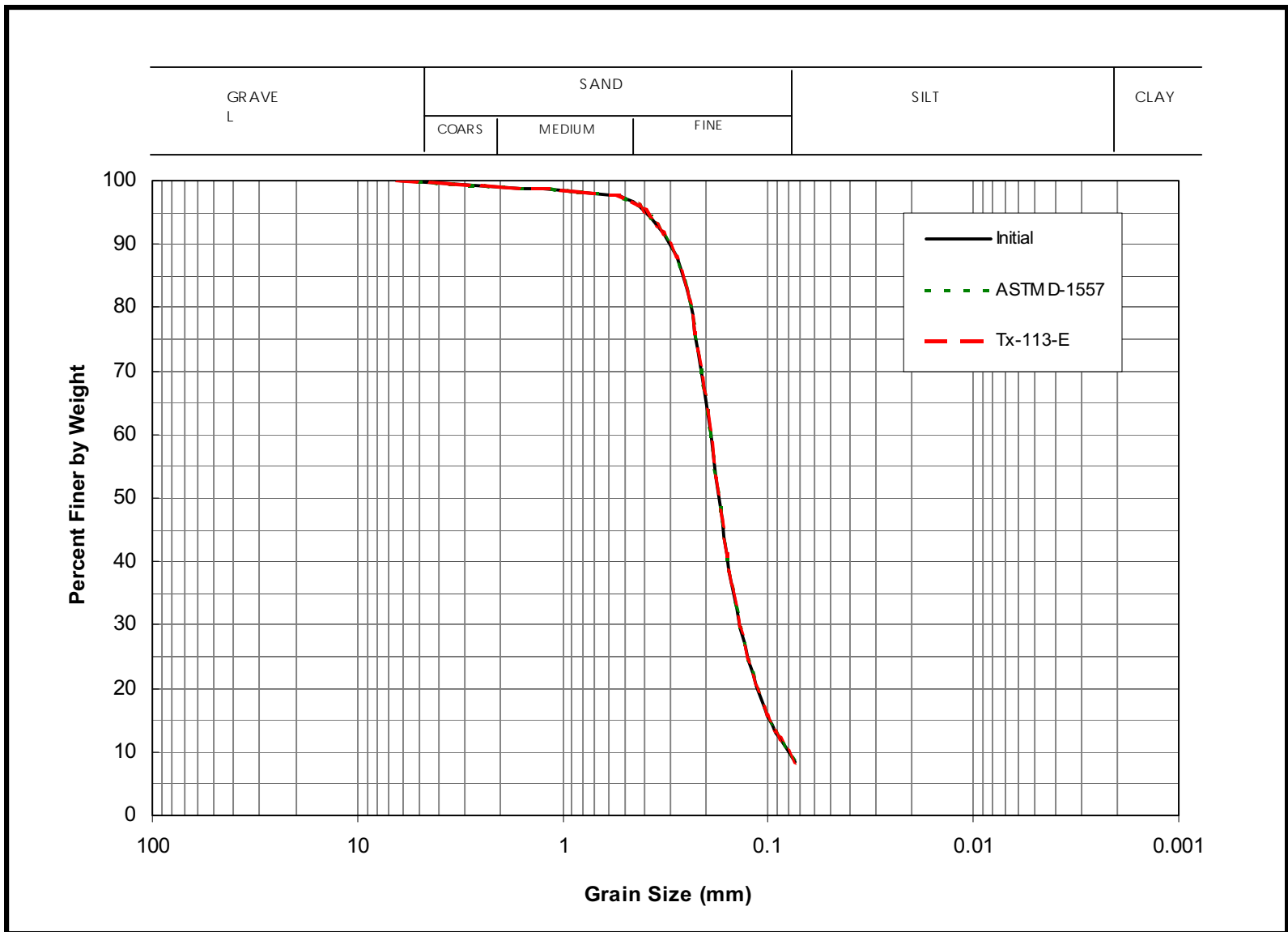

Figure A.7: Initial grain size curve of Austin soil (SP-SM) and curves after impact compaction tests

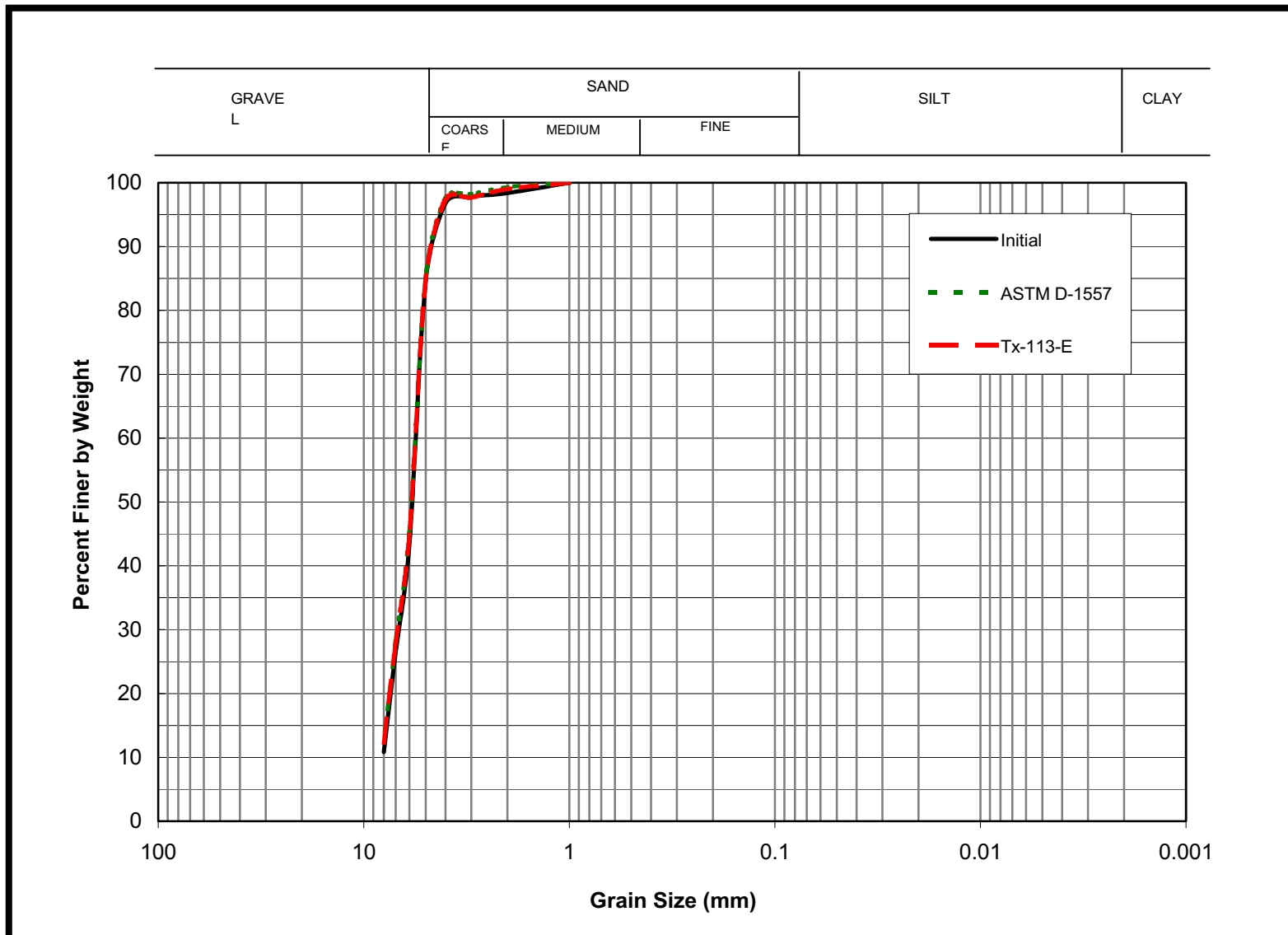

Figure A.8: Initial grain size curve of Houston soil (SP-SM) and curves after impact compaction tests

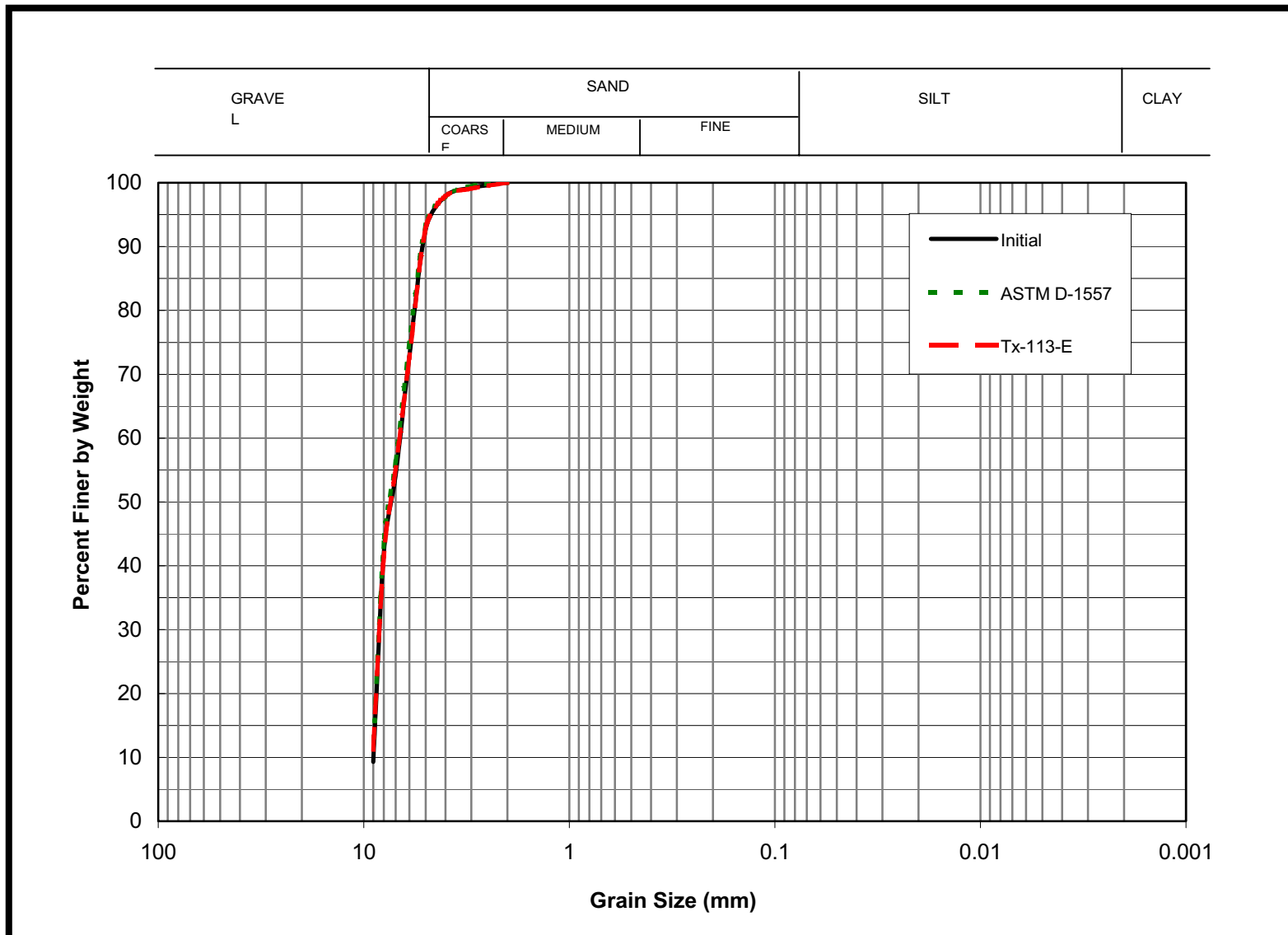

Figure A.9: Initial grain size curve of Redd Road soil (SP-SM) and curves after impact compaction tests

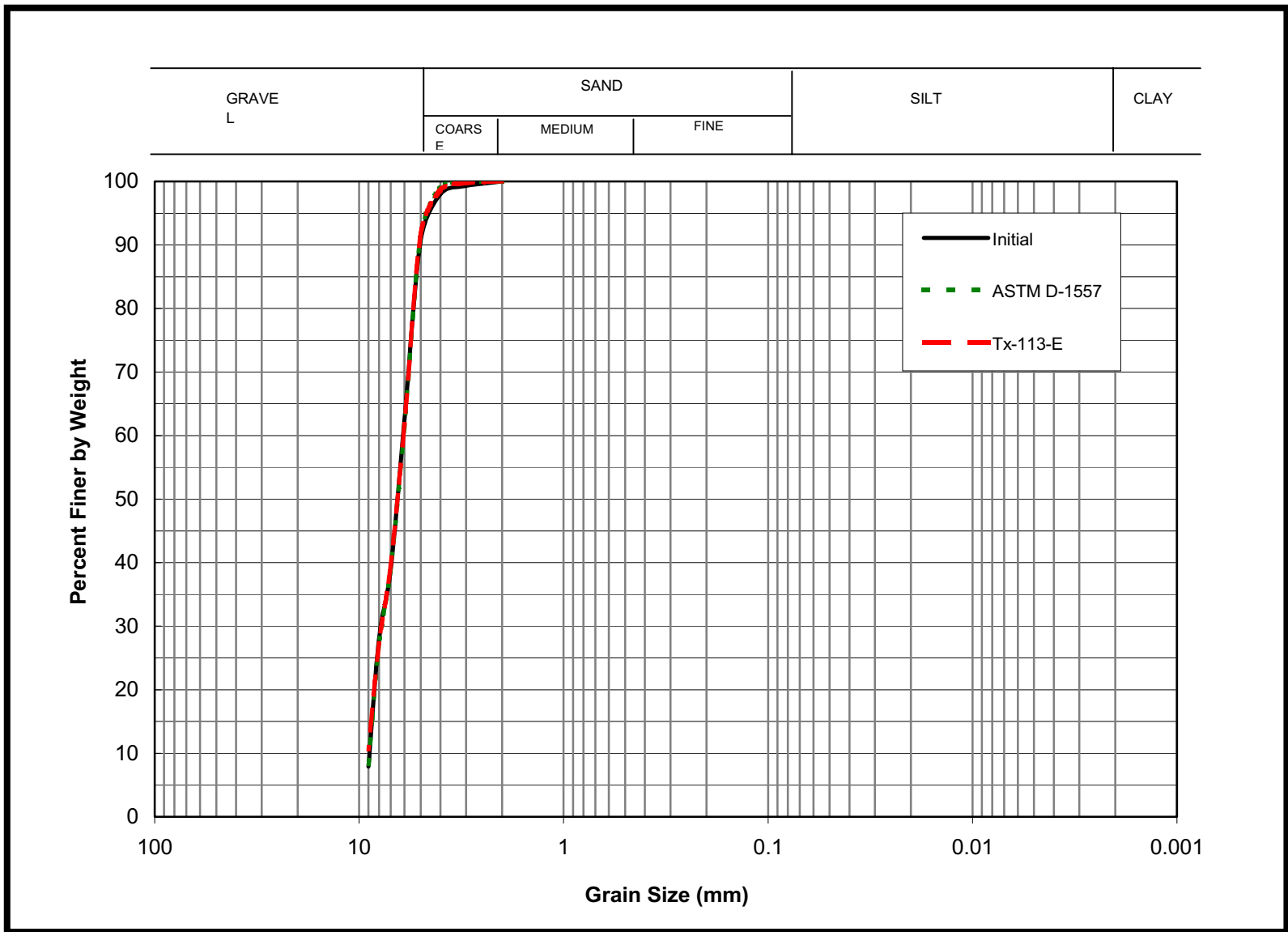

Figure A.10: Initial grain size curve of Horizon soil (SP-SM) and curves after impact compaction tests

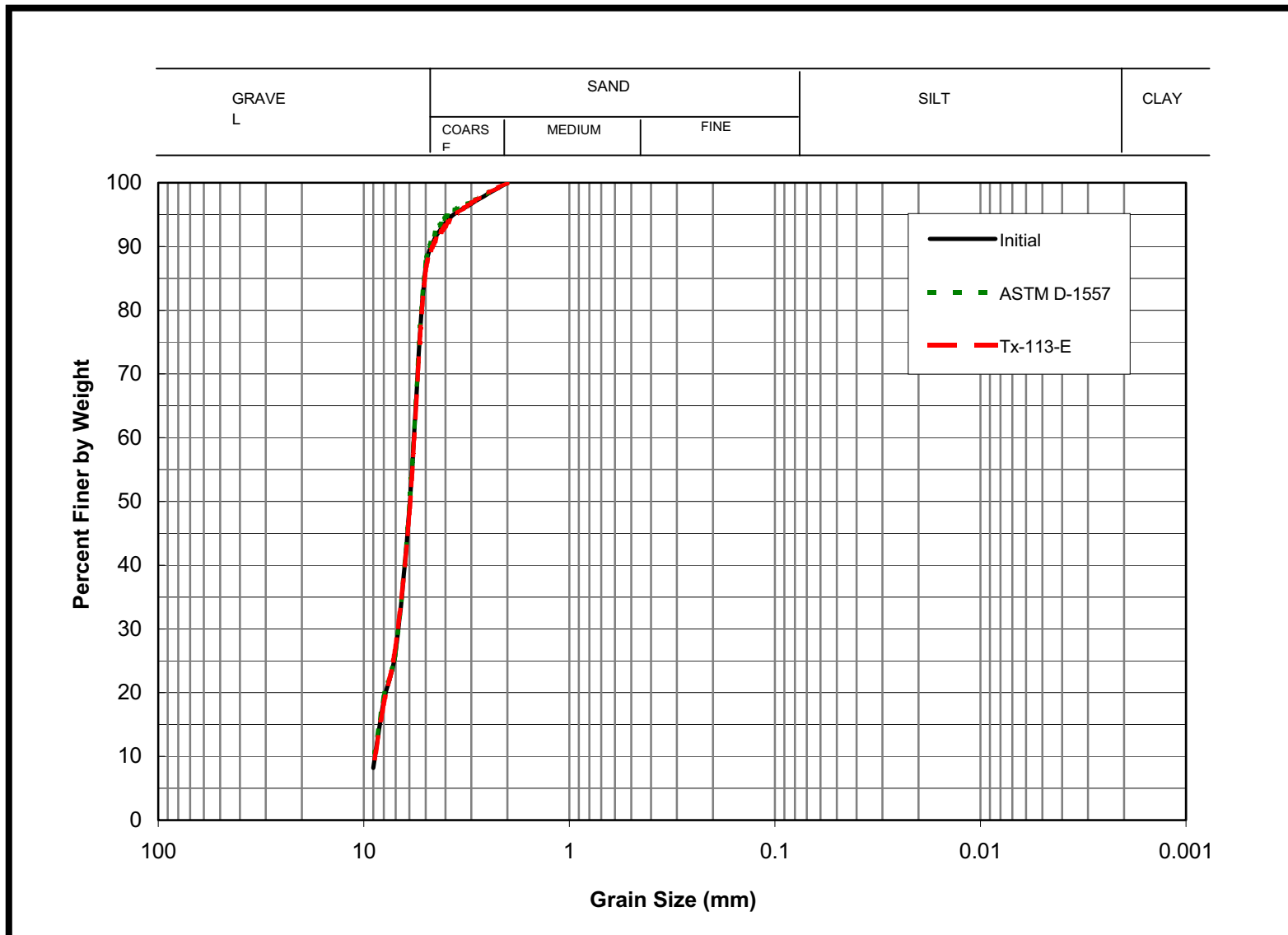

Figure A.11: Initial grain size curve of NW w/Ag. soil (SP-SM) and curves after impact compaction tests

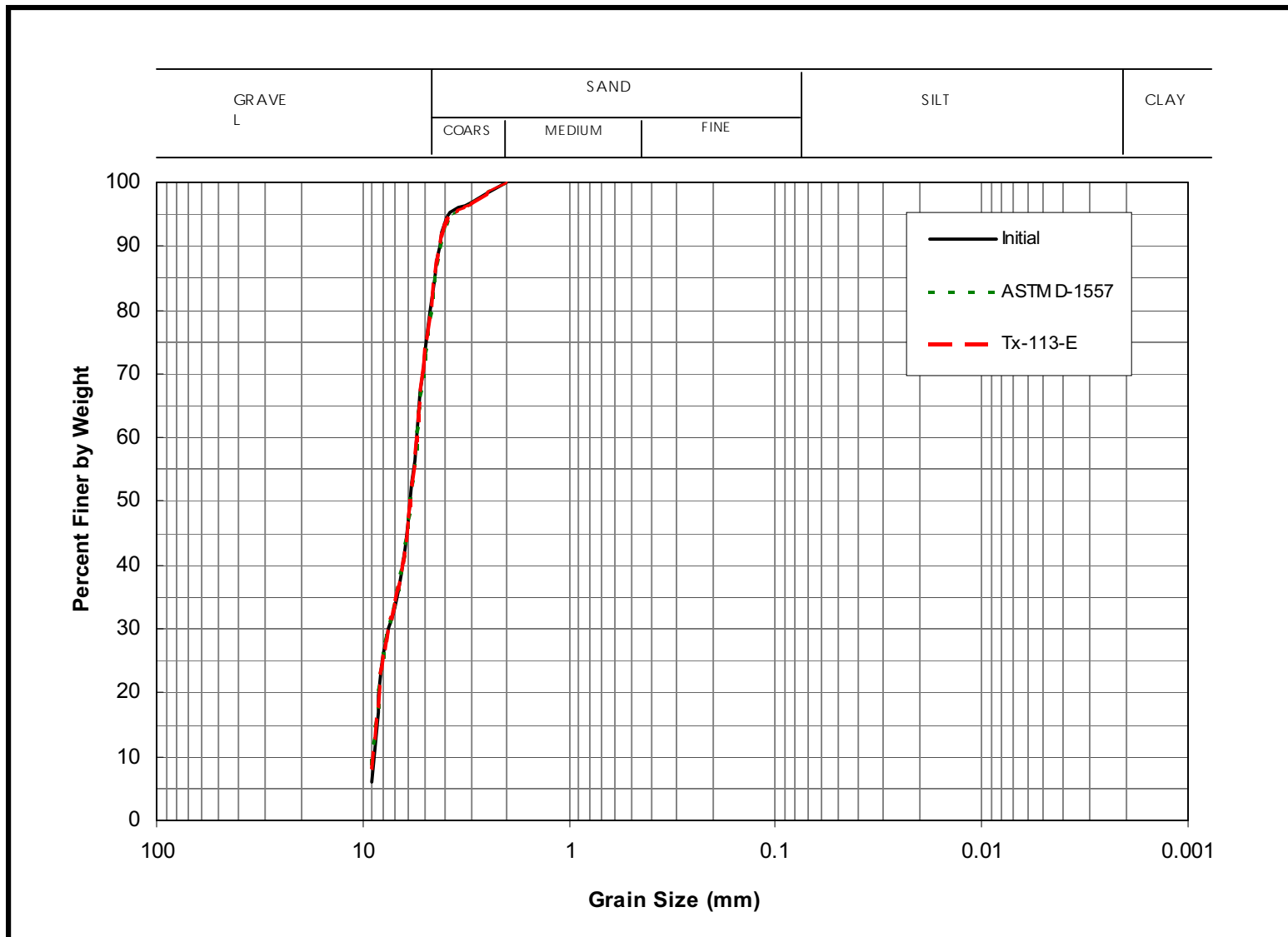

Figure A.12: Initial grain size curve of Acala soil (SP-SM) and curves after impact compaction tests

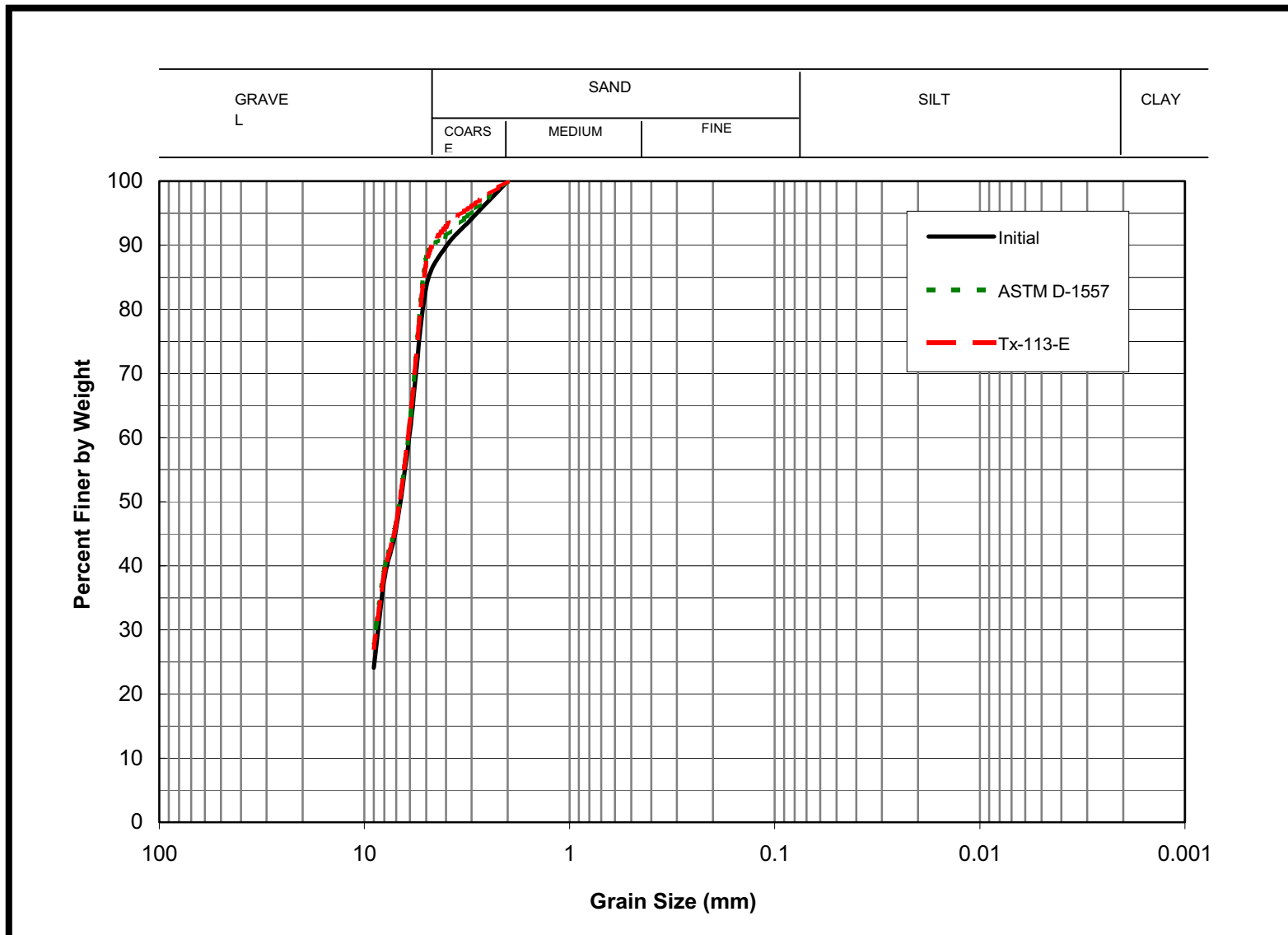

Figure A.13: Initial grain size curve of NWTLE soil (SM) and curves after impact compaction tests

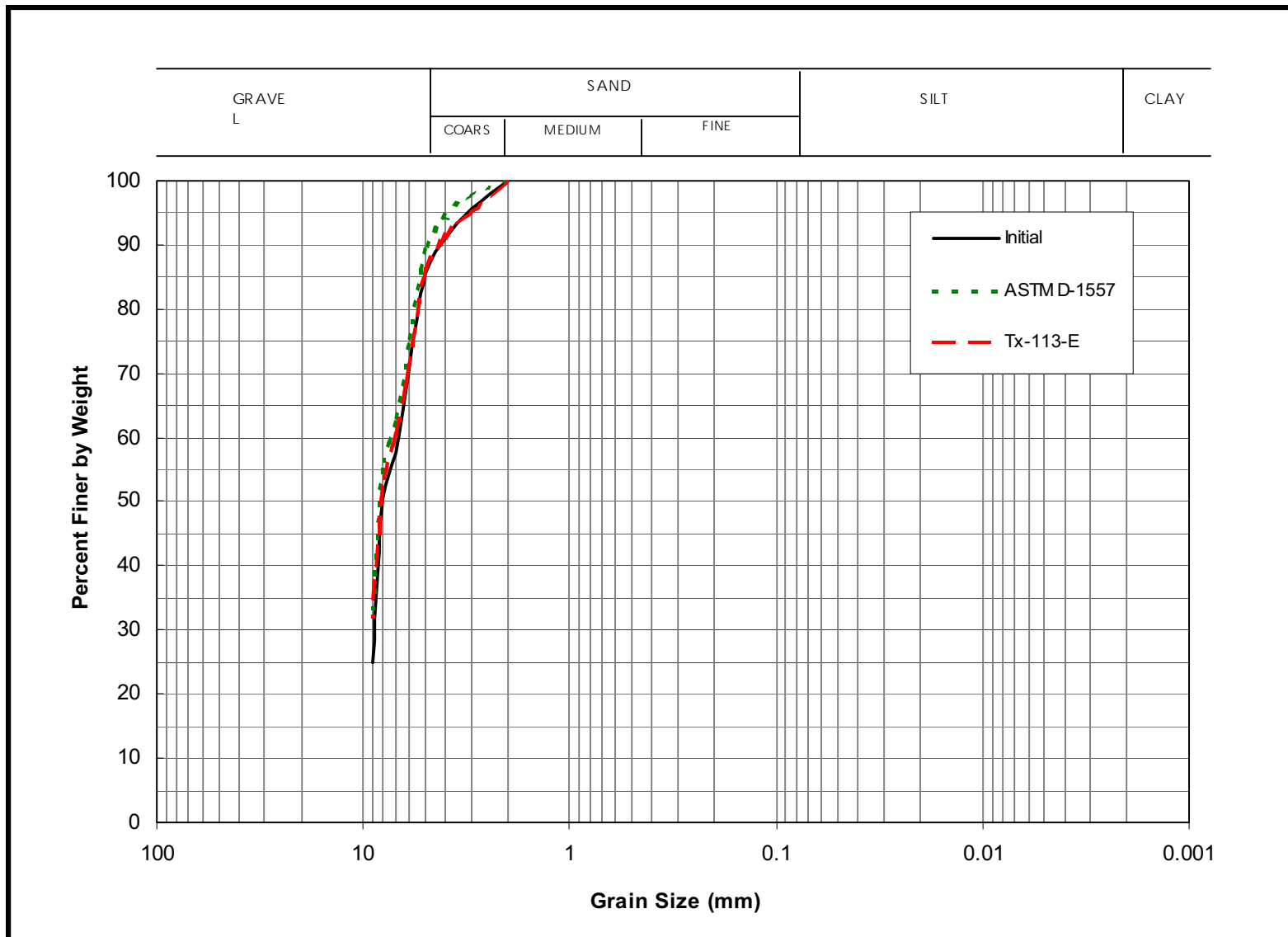

Figure A.14: Initial grain size curve of MP 53 soil (SM) and curves after impact compaction tests

BIBLIOGRAPHY

- American Society for Testing and Materials (1998). *ASTM Book of Standards*, Sec. 4, Vol. 04.08, Philadelphia, Pa.
- British Standard Institute (1990). "Compaction Using Vibrating Hammer," *BS 1377:1990*, London, England.
- Bros, B., and Orzesyna, H. (1979), "The Influence of Particles Angularity and Surface Roughness On Engineering Properties of Sands," *Design Parameters in Geotechnical Engineering*, British Geotechnical Society, London, pp. 11-14.
- Burmister, D. M. (1948), "Suggested Methods of Test for Maximum and Minimum Densities of Granular Soils," *Special Procedures for Testing Soil and Rock for Engineering Purposes, ASTM STP 479*, ASTM, pp. 114-116.
- Burmister, D. M. (1970), "Suggested Methods of Test For Maximum and Minimum Densities of Granular Soils," *ASTM Special Technical Publication #479*, pp. 114-116.
- Chapman, T .G. and Ray, P. N. (1954), "The British Standard Compaction Test for Soils: A Study of Some Factors Affecting the Test Results," *Geotechnique*, Vol. 4, Dec., pp. 169-177.
- Christensen, B. (1999). *State and National Agency Standard Specification Review*, Master's Report, The University of Texas at Austin, p. 92.
- Cornforth, D. H. (1973), "Prediction of Drained Strength of Sands from Relative Density Measurements," *Evaluation of Relative Density and Its Role in Geotechnical Projects Involving Cohesionless Soils, ASTM STP 523*, ASTM, pp. 281-303.
- Das, B. M. (1994), *Principles of Geotechnical Engineering*, PWS Publishing Company, Boston, Third Ed., p. 605.
- Delphia, J. (1998), *MSE Compaction Specifications*, Master's Thesis, Texas A&M University, p. 147.
- Farrar, J. A. (1999), "Compaction Control of Coarse Grained Aggregates," *Earth Sciences and Research Laboratory*, Bureau of Reclamation, Denver, Colorado, USA.
- Felt, E. J. (1958), "Laboratory Methods of Compacting Granular Soils," *Symposium on Applications of Soil Testing in Highway Design and Construction, ASTM STP 479*, ASTM, pp. 114-116.

- Frossblad, L. (1967), "New Method for Laboratory Soil Compaction by Vibration," *Symposium on Compaction of Earthwork and Granular Bases, Highway Research Record, No. 177*, pp. 219-225.
- Head, K. H. (1980). *Manual of Soil Laboratory Testing*, Vol. 1, pp. 291-298.
- Holtz, W. G. (1973), "The Relative Density Approach-Uses, Testing Requirements, Reliability, and Shortcomings," *Evaluation of Relative Density and Its Role in Geotechnical Projects Involving Cohesionless Soils, ASTM STP 523*, ASTM, pp. 5-17.
- Lacroix, Y. and Horn, H. M. (1973), "Direct Determination and Indirect Evaluation of Relative Density and Its Use on Earthwork Construction Projects," *Evaluation of Relative Density and Its Role in Geotechnical Projects Involving Cohesionless Soils, ASTM STP 523*, ASTM, pp. 251-280.
- Leary, D. J., and Woodward III, R. J. (1973), "Experience with Relative Density as a Construction Control Criterion," *Evaluation of Relative Density and Its Role in Geotechnical Projects Involving Cohesionless Soils, ASTM STP 523*, ASTM, pp. 381-401.
- Monahan, E. J. (1986). *Construction Of and On Compacted Fills*, John Wiley and Sons, pp. 76-139.
- National Research Council (1965). *Criteria For Compacted Fills*, Building Research Advisory Board, Publication 1281, March, 1965, p. 45.
- Poulos, S. J. (1998), "Compaction Control and the Index Unit Weight," *Geotechnical Testing Journal*, GTJODJ, Vol. 11, No. 2, June 1988, pp. 100-108.
- Poulos, S. J. and Hed, A. (1973), "Density Measurements in a Hydraulic Fill," *Evaluation of Relative Density and Its Role in Geotechnical Projects Involving Cohesionless Soils, ASTM STP 523*, ASTM, pp. 402-424.
- Proctor, R. R. (1933), "Design and Construction of Rolled Earth Dams," *Engineering News Record*, Vol. 3, pp. 245-248, pp. 286-289, pp. 348-351, pp. 372-376.
- Roston, J. P., Roberts, F. L., and Baron, W. (1976), "Density Standards for Field Compaction of Granular Bases and Subbases," *National Cooperative Research Report 172*, Washington, D.C., p. 57.
- Schoroeder, W. L. (1984). *Soils in Construction*, Third Ed., John Wiley and Sons, pp. 114-139.
- Scott, C. R. (1980). *An Introduction to Soil Mechanics and Foundations*, Third Ed., Applied Science Publishers, p. 406.

- Selig, E. T. and Ladd, R. S. (1973), "Evaluation of Relative Density Measurements and Applications," *Evaluation of Relative Density and Its Role in Geotechnical Projects Involving Cohesionless Soils, ASTM STP 523*, ASTM, pp. 487-504.
- Standard Specifications for Construction of Highways, Streets, and Bridges (1993). Texas Department of Transportation, pp. 77-83, pp. 624-633.
- Tavenas, F. A. (1973), "Difficulties in the Use of Relative Density as a Soil Parameter," *Evaluation of Relative Density and Its Role in Geotechnical Projects Involving Cohesionless Soils, ASTM STP 523*, ASTM, pp. 478-483.
- Tiedemann, D. A. (1973), "Variability of Laboratory Relative Density Test Results," *Evaluation of Relative Density and Its Role in Geotechnical Projects Involving Cohesionless Soils, ASTM STP 523*, ASTM, pp. 61-73.
- Townsend, F.C. (1973), "Comparisons of Vibrated Density and Standard Compaction Tests on Sand with Varying Amounts of Fines," *Evaluation of Relative Density and Its Role in Geotechnical Projects Involving Cohesionless Soils, ASTM STP 523*, ASTM, pp. 348-363.
- TxDOT Manual of Testing Procedures (1993). *Test Method Tx-114-E*, Texas Department of Transportation, p. 18.
- Waidelich, W. C. (1990), "Earthwork Construction," *Guide to Earthwork Construction*, Transportation Research Board, Washington, D.C., pp. 25-40.
- Williamson, T. G. and Walsh, H. J. (1969), "Development of a High-Velocity Impact Test for Laboratory Compaction of Granular Materials," *Highway Research Record*, No. 184, pp. 37-50.
- Youd, T. L. (1972), "Compaction of Sands by Repeated Shear Straining," *Journal of the Soil Mechanics and Foundations Division, ASCE*, Vol. 98, No. SM7, July, pp. 709-725.
- Youd, T. L. (1973), "Factors Controlling Maximum and Minimum Densities of Sands," *Evaluation of Relative Density and Its Role in Geotechnical Projects Involving Cohesionless Soils, ASTM STP 523*, ASTM, pp. 98-112.